

Illinois Pollution Control Board
R2014-10
Testimony of Keir Soderberg
References

**Environment Agency: The Hyporheic Handbook - A
Handbook on the Groundwater-Surface Water
Interface and Hyporheic Zone for Environment
Managers (2009)**



using science to
create a better place



The Hyporheic Handbook

A handbook on the groundwater–surface water interface
and hyporheic zone for environment managers

Integrated catchment science programme
Science report: SC050070

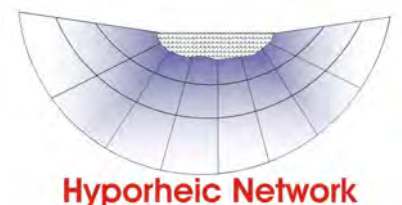

The Environment Agency is the leading public body protecting and improving the environment in England and Wales.

It's our job to make sure that air, land and water are looked after by everyone in today's society, so that tomorrow's generations inherit a cleaner, healthier world.

Our work includes tackling flooding and pollution incidents, reducing industry's impacts on the environment, cleaning up rivers, coastal waters and contaminated land, and improving wildlife habitats.

This report is the result of research funded by NERC and supported by the Environment Agency's Science Programme.

Published by:

Environment Agency, Rio House, Waterside Drive,
Aztec West, Almondsbury, Bristol, BS32 4UD
Tel: 01454 624400 Fax: 01454 624409
www.environment-agency.gov.uk

ISBN: 978-1-84911-131-7

© Environment Agency – October, 2009

All rights reserved. This document may be reproduced with prior permission of the Environment Agency.

The views and statements expressed in this report are those of the author alone. The views or statements expressed in this publication do not necessarily represent the views of the Environment Agency and the Environment Agency cannot accept any responsibility for such views or statements.

This report is printed on Cyclus Print, a 100% recycled stock, which is 100% post consumer waste and is totally chlorine free. Water used is treated and in most cases returned to source in better condition than removed.

Further copies of this summary are available from our publications catalogue: <http://publications.environment-agency.gov.uk> or our National Customer Contact Centre: T: 08708 506506
E: enquiries@environment-agency.gov.uk.

Dissemination Status:

Released to all regions
Publicly available

Keywords:

hyporheic zone, groundwater-surface water interactions

Environment Agency's Project Manager:

Joanne Briddock, Yorkshire and North East Region

Science Project Number:

SC050070

Product Code:

SCHO1009BRDX-E-P

Science at the Environment Agency

Science underpins the work of the Environment Agency. It provides an up-to-date understanding of the world about us and helps us to develop monitoring tools and techniques to manage our environment as efficiently and effectively as possible.

The work of the Environment Agency's Science Department is a key ingredient in the partnership between research, policy and operations that enables the Environment Agency to protect and restore our environment.

The science programme focuses on five main areas of activity:

- **Setting the agenda**, by identifying where strategic science can inform our evidence-based policies, advisory and regulatory roles;
- **Funding science**, by supporting programmes, projects and people in response to long-term strategic needs, medium-term policy priorities and shorter-term operational requirements;
- **Managing science**, by ensuring that our programmes and projects are fit for purpose and executed according to international scientific standards;
- **Carrying out science**, by undertaking research – either by contracting it out to research organisations and consultancies or by doing it ourselves;
- **Delivering information, advice, tools and techniques**, by making appropriate products available to our policy and operations staff.



Steve Killeen

Head of Science

Authors

Steve Buss

ESI Ltd, New Zealand House, 160-162 Abbey Foregate, Shrewsbury, Shropshire, SY2 6FD, UK.

Zuansi Cai

Groundwater Protection and Restoration Group, University of Sheffield, Broad Lane, Sheffield S3 7 HQ, UK.

Bayarni Cardenas

Jackson School of Geosciences, University of Texas at Austin, USA.

Jan Fleckenstein

Department of Hydrology, University of Bayreuth, Universitatstrasse 30, 95447 Bayreuth, Germany.

David Hannah

School of Geography, Earth and Environmental Sciences, University of Birmingham, Birmingham, B15 2TT, UK.

Kate Heppell

Department of Geography, Queen Mary University of London, London, E1 4NS, UK.

Paul Hulme

Environment Agency, Olton Court, 10 Warwick Road, Solihull B92 7HX, UK.

Tristan Ibrahim

Catchment Science Centre, Kroto Research Institute, University of Sheffield, Broad Lane, Sheffield S3 7HQ, UK.

Daniel Kaeser

Centre for Sustainable Water Management, Lancaster Environment Centre, Lancaster LA1 4AP, UK.

Stefan Krause

School of Physical and Geographical Sciences, Earth Sciences and Geography Department. Keele University, Keele, ST5 5BG, UK.

Damian Lawler

School of Geography, Earth and Environmental Sciences, University of Birmingham, Birmingham, B15 2TT, UK.

David Lerner

Catchment Science Centre, Kroto Research Institute, University of Sheffield, Broad Lane, Sheffield S3 7HQ, UK.

Jenny Mant

River Restoration Centre, Cranfield University, Building 53, Cranfield, Bedfordshire MK43 0AL, UK.

Iain Malcolm

Marine Scotland, Freshwater Laboratory, Faskally, Pitlochry, Perthshire PH16 5LB, UK.

Gareth Old

Centre for Ecology and Hydrology, Wallingford, Oxford, OX10 8BB, UK.

Geoff Parkin

School of Civil Engineering and Geosciences, Newcastle University, Newcastle Upon Tyne, NE1 7RU.

Roger Pickup

Biomedical and Life Sciences Division, School of Health and Medicine, Lancaster University, Lancaster, LA1 4YQ, UK.

Gilles Pinay

School of Geography, Earth and Environmental Sciences, University of Birmingham, Birmingham, B15 2TT, UK.

Jonathan Porter

Environment Agency, Starcross Laboratory, Staplake Mount, Starcross, Exeter Devon EX6 8PE, UK.

Glenn Rhodes

Centre for Ecology and Hydrology, Lancaster Environment Centre, Library Avenue, Bailrigg, Lancaster, LA1 4AD, UK.

Anna Richie

Catchment Science Centre, Kroto Research Institute, University of Sheffield, Broad Lane, Sheffield S3 7HQ, UK.

Janet Riley

ESI Ltd, New Zealand House, 160-162 Abbey Foregate, Shrewsbury, Shropshire, SY2 6FD, UK.

Anne Robertson

School of Human and Life Sciences, Roehampton University, London, SW15 4JD, UK.

David Sear

School of Geopgraphy, University of Southampton, Southampton, SO17 1BJ, UK.

Brian Shields

Environment Agency, Richard Fairclough House, Knutsford Road, Warrington, Cheshire WAA 1HT, UK.

Jonathan Smith

Catchment Science Centre, Kroto Research Institute, University of Sheffield, Broad Lane, Sheffield S3 7HQ, UK.

John Tellam

School of Geography, Earth and Environmental Sciences, University of Birmingham, Birmingham, B15 2TT, UK.

Paul Wood

Department of Geography, Loughborough University, Loughborough, Leicestershire, LE11 3TU, UK.

Acknowledgements

The Hyporheic Handbook is a product of the Hyporheic Network.

The Hyporheic Network is a Natural Environment Research Council (NERC) funded Knowledge Transfer Network on groundwater – surface water interactions and hyporheic zone processes.

The authors wish to acknowledge the support and assistance of many colleagues who have contributed to the review, production and publishing of the Handbook:

Joanne Briddock, Mark Cuthbert, Thibault Datry, John Davis, Rolf Farrell, Richard Greswell, Jan Hookey, Tim Johns, Dave Johnson, Arifur Rahman.

We are also very grateful for the support and efforts of the Environment Agency Science Communication department, in particular, Stuart Turner and our editor Hazel Phillips.

Contents

1 Introduction	1
1.1 Background and objectives of the handbook	1
1.2 Why is the groundwater–surface water interface important?	2
1.3 How can the hyporheic zone be damaged?	3
1.4 Conceptual models	4
2 Environmental management context	6
2.1 Legislative drivers	6
2.2 Legislative and management context	6
2.3 Environmental management questions	10
3 Geomorphology and Sediments of the Hyporheic Zone	16
3.1 Summary of key messages	16
3.2 Introduction	18
3.3 Long timescale impacts: valley materials and geomorphology materials	20
3.4 Basin scale geomorphological contexts	22
3.5 Reach scales	30
3.6 Site and bedform scales	31
3.7 The role of fine sediment	32
3.8 Conclusions	43
4 Water and unreacting solute flow and exchange	48
4.1 Summary of key messages	48
4.2 Introduction	48
4.3 Catchment Scale Flow	49
4.4 Reach Scale Flow	54
4.5 Sub-Reach Scale Flow	67
4.6 Other Factors	75
4.7 River Bed Sediment Permeability	76
4.8 An Overview of the Flow System in the River/Aquifer Interface Zone	78
4.9 Solute Transport	83
4.10 Towards Prediction	91
5 Biogeochemistry and hydroecology of the hyporheic zone	92
5.1 Summary of key messages	92
5.2 Chapter Scope	93
5.3 Perspectives on the hyporheic zone (HZ)	93
5.4 Processes, functions and scaling	94
6 Microbial and invertebrate ecology	108
6.1 Introduction	108
6.2 Microbial ecology of protozoa, fungi and bacteria: global scale	108
6.3 Global scale biogeochemical processes and cycles	108
6.4 Hyporheic zone as a biological entity	109
6.5 Microbial ecology in the hyporheic zone	110
6.6 Physical location of microbes	110
6.7 Biofilms	111
6.8 Microbial diversity (functional groups)	111
6.9 Decomposition under anaerobic conditions	113
6.10 Chemolithotrophy: energy via inorganic compounds	113
6.11 Bacterial Community identity	114
6.12 Fungi	115
6.13 Protozoa	115
6.14 Microbial pathogens in HZ	117
6.15 HZ is a biological entity	117
6.16 Investigating microbial ecology of HZ	118

7 Fish ecology and the hyporheic zone	123
7.1 Summary of key messages	123
7.2 Introduction	123
7.3 Salmonid spawning behaviour/process	124
7.4 Timing of spawning and incubation	124
7.5 Factors affecting embryo development	125
7.6 Research needs	135
7.7 Recommendations for management	136
7.8 Conclusions	136
8 Measurements and monitoring at the groundwater-surface water interface	137
8.1 Summary of key messages	137
8.2 Introduction	138
8.3 Designing a monitoring programme	138
8.4 Implementing a monitoring strategy	140
8.5 Conclusions	165
9 Modelling and forecasting	166
9.1 Summary of key messages	166
9.2 Review of the science	167
9.3 Conclusions	185
10 Groundwater-surface water interactions and River Restoration	190
10.1 Introduction	190
10.2 What is River Restoration?	191
10.3 Review of River Restoration	191
10.4 Scale of implementation and impact	193
10.5 The need for physical, hydrological, chemical and biological integration	193
10.6 What are the key processes used?	194
10.7 Influences of river restoration activities on GW/SW exchange	194
10.8 Flood alleviation schemes and climate change	195
10.9 River restoration actions and possible implications for GW/SW exchange	196
10.10 Reducing GW/SW exchange	207
10.11 Timescales and monitoring relative to the disturbance of the activity	209
10.12 Need for continued river management	209
10.13 Project appraisal and research needs	210
10.14 Conclusion	212
11 Recommendations for development of river management strategies and tools	213
12 Recommendations for research	218
12.1 Introduction	218
12.2 Significance of groundwater - surface water	218
12.3 Process understanding of groundwater - surface water interactions	220
12.4 Monitoring and modelling tools	221
12.5 Conclusions	222
Glossary	223
References	230

List of figures

Figure 1.1 Illustrative representation of the groundwater – surface water interface and hyporheic zone. (Reproduced with permission of USGS).	1
Figure 1.2 Illustrative conceptual models of the groundwater – surface water interface and hyporheic zone commonly assumed in differing scientific literatures (after Smith, 2005).	5
Figure 2.1 WFD requires assessment of groundwater–surface water interactions (after Environment Agency 2002).	8
Figure 2.2 Typical contaminated-site assessment using the <i>source–pathway–receptor</i> framework. Use of a compliance-monitoring borehole adjacent to the stream (A) excludes any potential attenuation at the GW-SW interface (B) (after Smith & Lerner, 2008, based on Environment Agency, 2002).	10
Figure 3.1 Sediment supplies and connections in a catchment context (Sear et al., 2004).	19
Figure 3.2 Glacial limits for the Devensian in the UK (Bowen et al., 2002).	21
Figure 3.3 Complexity of valley fills: example of the River North Tyne (Lewin et al., 2005).	22
Figure 3.4 Schematic cross-section across the Lambourn valley at West Shefford showing the location of measuring points and the inferred relationship of valley floor sedimentology to local and regional groundwater flows (Grapes et al., 2006).	24
Figure 3.5 Conceptual model of three groundwater flow regimes (1-3) moving down gradient towards the R. Lambourn, southern England (Gooddy et al., 2006).	24
Figure 3.6 Zones of bedrock constriction and permeable alluvial deposits, showing deep penetration of surface water into the alluvium (Stanford and Ward, 1993).	25
Figure 3.7 Example hydraulic geometry relations for a small stream (Ashley River basin, New Zealand) defining approximate power-law downstream changes in channel width, mean depth, mean velocity and slope in relation to increasing discharge, based on an approach pioneered by Leopold and Maddock (1953). Source: McKerchar et. al., 1998).	26
Figure 3.8 Conceptual generalized stream power model proposed by Lawler (1992), now known as the CASSP (CAatchment-Scale Stream Power) model. This schematic example simulates downstream trends in gross stream power using CASSP, with coefficients of $k = 0.03$, $m = 1.8$, $S_0 = 0.04$ and $r = 0.08$, and is presented in Barker et al. (2009).	28
Figure 3.9 Downstream changes in discharge (QMED: the median annual flood, i.e. 2-year return period flow), elevation, channel (floodplain) slope and gross stream power for the River Dart, Devon (after Barker et al., 2009). This new CAFES (<i>Combined Automated, Flood, Elevation and Stream power</i>) methodology has now been applied to 34 rivers in the UK, to produce downstream change patterns as for the R. Dart above. For eight of the 34 rivers, additional downstream trends in specific stream power (in $W m^{-2}$) have been estimated.	29
Figure 3.10 Hyporheic flow due to changes in free water surface elevation across a step-pool sequence.	31
Figure 3.11 Subsurface flows; (a) Reach-scale surface subsurface exchange flows. (b) Micro-scale exchange flows (redd). (c) Interstitial flow paths within the gravel bed (after Grieg et al., 2007).	32
Figure 3.12 Hyporheic flow due to lateral changes in channel and bank morphology. a) hyporheic flow due to subtle changes in bank morphology even without a mean change in channel sinuosity, b) hyporheic flow along unit bars on the sides of the channels, c) hyporheic flow due to channel sinuosity.	33
Figure 3.13 Hyporheic flow due to gradients in dynamic head formed when water flow encounters an irregular boundary (bedform).	34
Figure 3.14 Hyporheic flow due variability of hydraulic properties of the alluvial material. a) case with no variability leading to no hyporheic flow, b) heterogeneous streambed, c) variability in bedrock or ‘aquitard’ topography.	35
Figure 3.15 Sediment infiltration into river beds: a: Passive infiltration into a gravel bed; b: Relationship between gravel bed type and infiltrating sediment; c: Three	37

- filtration mechanisms for sediment infiltration into porous beds. Note the particle size dependence and difference in deposit morphology (Modified from McDowell-Boyer et al. 1986 and Sear et al. 2008).
- Figure 3.16** Strong correlation between fine sediment accumulation and oxygen supply rate (Sear et al., 2008). 39
- Figure 3.17** Relationship between stream power and percentage sediment sub-1 mm in upland (Type I), small chalk (Type II) and sandstone/limestone (Type II) streams (source: Milan et al., 2000). 40
- Figure 3.18** Temporal variation in a) average deposition rate of material finer than 4mm across each section b) daily suspended sediment concentration and c) mean daily discharge. Solid squares represent upstream traps and open squares represent downstream traps (source: Acornley and Sear, 1999). 42
- Figure 4.19** Average particle size distributions of fine sediment deposited in June, November and February. Representative distributions are also presented for the suspended load and bedload in the study reach (source: Acornley and Sear, 1999). 46
- Figure 4.1** Schematic hydrographs for streams in continuity with aquifers of fast (e.g. chalk) and slow (e.g. sandstone) aquifer response times (Downing et al., 1974). 51
- Figure 4.2** Cartoon of a river catchment in an area of temperate climate showing the general groundwater flow patterns: (a) horizontal components (b) vertical components. In (b) spring discharges may occur on valley sides. 53
- Figure 4.3** Nested flow systems in areas of complex topography [Dahl et al. (2007) after Toth (1970)]. 54
- Figure 4.4** The possible geometrical relationships between rivers and groundwater flow. (a) geometrical classes A to E discussed in the text. After Woessner (2000). (b) typical geometrical relationships from head water reaches to lower reaches (circles indicate flow out of the page). 55
- Figure 4.5** Groundwater flow (a) perpendicular to and (b) parallel with a river channel. (c) the more general case with the flow direction intermediate between cases (a) and (b). After Larkin and Sharp (1992). 56
- Figure 4.6** Modelling results for flows through pool-step-riffle and pool-riffle-step sequences of three reaches of Lookout Creek, Oregon, USA (Gooseff et al., 2005). 58
- Figure 4.7** A conceptualization of river bed flows associated with riffled gravel bar reaches [Malcolm et al. (2003), after Malard et al. (2002)]. Only vertical flows are shown: in addition, there will often be lateral flows into the surrounding alluvium that pass around the riffle and emerge again into the channel downstream; there will also be flows that pass across the meander loop (see Figure 9). The deep groundwater discharges (white arrows) will either pass around the outside of the shallow flows or discharge between one gravel bar and the next [*cf.* Figure 14 (b)]. 59
- Figure 4.8** Vertical and lateral flows in the vicinity of a riffle in an effluent gravel-bed stream in Canada as modelled by Storey et al. (2003), showing sensitivity to bed permeability, groundwater discharge (winter = 2 summer), and head difference across the riffle. (a) head difference across riffle as in summer; (b) head difference across riffle as in winter (= half that for summer). 60
- Figure 4.9** Modelled flow patterns across three meander loops of increasing sinuosity (Cardenas, 2008a). The darker lines indicate flow paths and the lighter lines are head contours. The flow in the river is from left to right. 61
- Figure 4.10** (a) river stage rise and inundation of the floodplain, ignoring groundwater (Mertes, 1997). (b) possible impacts on groundwater system – bank storage (Winter et al., 1998). (c) a modified version of (a), including the effects of direct precipitation on the floodplain and rise in groundwater level, both causing local flooding (Mertes, 1997). Which model, or combination of models, is closest to reality will depend on several factors including alluvial deposit groundwater flow system, timing and location of rainfall, and local topography. 62
- Figure 4.11** (a) schematic diagram of the flow system in the vicinity of a well adjacent to a river with no regional groundwater flow (Raudkivi and Callander, 1976). (b) the increase with (dimensionless) time of flow from a river (q) as a proportion of well abstraction rate (Q) for a river in perfect hydraulic continuity with an aquifer with a horizontal water table (i.e. no regional groundwater flow)(Butler et al., 2001)[a = distance from well to river measured perpendicular to the river; S = aquifer storage coefficient; T = aquifer transmissivity; t = time]. (c) flow in the vicinity of an abstracting 64

- well close to an effluent river: for relatively low pumping rates (or short time since pumping commenced) (top) where the well reduces the baseflow to the river but river water is not entering the aquifer; for higher pumping rates (or longer times since pumping commenced) where the abstraction has reversed the hydraulic gradient and water is flowing from the river into the aquifer (bottom) (Raudkivi and Callander, 1976).
- Figure 4.12** The effects of abstraction on a river (Downing et al., 1974). (a) numerical model boundary conditions. (b) the fall in net gain as a function of time for a fast response time aquifer and a slow response time aquifer. (c) the change in net gain as a function of time for fast and slow response time aquifers for seasonal recharge and pumping. 66
- Figure 4.13** (a) a particular example of how the sources of water at an abstraction well near a stream change as a function of time since pumping began as calculated by Chen (2003); note that the proportions will change with system parameter values. (b) the variation in stream infiltration rate (top) and reduction in baseflow rate (bottom) during pumping and after pumping ceases for a well located at distance L from a stream in a groundwater system with an hydraulic gradient of I, as calculated for a particular example by Chen (2003). Pumping stops at 120 days. 67
- Figure 4.14** Two representations of flow through a unit bedform (e.g. a dune). (a) schematic representation from Wörman et al. (2002). (b) numerical model results from a turbulent surface water / laminar groundwater model from Cardenas and Wilson (2007a); note the eddy in the lee of the dune crest. Wavelength around 1m. 68
- Figure 4.15** The effect of upflow from an underlying aquifer on bedform-induced flows as modelled by Cardenas and Wilson (2006). Assumes laminar flow in stream. 70
- Figure 4.16** Modelled flow fields below bedforms for the case of effluent flow (top row) and influent flow (bottom row) by Cardenas and Wilson (2007a): surface water flow turbulent, with Reynolds' Numbers increasing towards the right as indicated. Contours are of pressures normalized as $p' = (p - p_{min}) / (p_{max} - p_{min})$. Arrows indicate flow directions, but not magnitudes. Solid lines indicate boundaries of the penetration of surface water. Effluent/influent groundwater flux/permeability is approximately 0.1, and bedforms are 1 metre across and have a 0.05 m crest height. No vertical exaggeration. 70
- Figure 4.17** Representations of the extent of surface water penetration into river bed deposits as indicated by steady-state modelling by Cardenas et al. (2004). h_{et} = heterogeneous permeability in sediments; h_{om} = homogeneous permeability; J_x = hydraulic gradient across stream axis; J_y = hydraulic gradient along axis of stream; A , = amplitude and wavelength of sinusoidal head variation applied to stream bed surface. The column of simulation results on the right indicate the effects of an increase in permeability heterogeneity from (a) to (e), with (e) corresponding to Simulation A (top left). 72
- Figure 4.18** Flow in the vicinity of: (a) a boulder on the sediment surface (White, 1990); (b) a weir [modified after Watson and Burnett (1993)]; and (c) *Chara* hummock sand deposits (plant not shown, but would be at up-stream edge of sand deposits) (White, 1990). 74
- Figure 4.19** The variation in space and time of the permeability (K) of stream bed sediments as measured using a falling head method in a tube inserted 36 cm below the sediment surface along a reach of West Bear Creek, North Carolina, USA (Genereux et al., 2008). Measurements were taken between December 2005 and December 2006. The red line indicates a beaver dam, and the dots indicate measurement points. 77
- Figure 4.20** Modelled groundwater heads and some near-stream groundwater flow paths for (a) high flow and (b) low flow conditions in Aspen Creek, New Mexico, USA (Wroblicky et al., 1998). Discharges to (>0) and from (<0) the stream bed are shown to the right. Stream flow is from right to left. 79
- Figure 4.21** Two dimensional modelling results for flows in the vicinity of the Umatilla River, Oregon, USA (Poole et al., 2008) during low flow in 2004. Panel A shows the groundwater flow lines and the groundwater head contours (m); colours along channel reaches indicate the flow path lengths associated with the discharge locations (recharging reaches are left un-ornamented). Panel B shows modelled flows between main and secondary channels. Panel C shows the effect of a beaver dam (white diamond) on local flows. Panel D maps out the flow directions across the alluvial plain 80

aquifer.

- Figure 4.22** A cartoon illustrating the 'hydrologic spiralling' concept of Poole et al. (2008). The figure shows a longitudinal cross-section of a stream system with flows leaving and subsequently re-joining the stream on a variety of space (and time) scales. Changes in arrow shading indicate changes in water temperature and chemistry. Plus and minus signs indicate effluent and influent flow zones associated with each of the nested flow paths. In some cases there will be groundwater discharge (or recharge) also. 82
- Figure 4.23** Results of in-stream tracer tests. (a) the tracer (tritium) breakthrough in stream waters at eight locations along a 30 km reach in Säva Brook, Sweden (Wörman et al., 2002). (b) concentration profiles in the stream bed sediment at the 0.13 km sampling location of (a) (concentrations in millilitres of 'wet substance')(Jonsson et al., 2003). (c) rhodamine WT tracer breakthrough in stream waters for experiments undertaken in 2003 (left) and 2004 (right) in streams in Jackson Hole, USA; the times have been normalized by dividing by the advective transport time (t_{adv}) (Gooseff et al., 2007). 84
- Figure 4.24** Unreacting solute movement fronts through meander loops of different sinuosities as indicated by modelling undertaken by Cardenas (2008a). The corresponding flow nets are given on Figure 9. Permeability is 50 m/d, porosity 0.3, and channel head gradient 0.0001. Longitudinal dispersivity is 0.1 m in all three cases with transverse dispersivity a tenth of this, and the front is indicated by the concentration / initial (i.e. up-stream boundary) concentration contour of 0.9. 85
- Figure 4.25** Breakthrough curves and residence time distributions for the three modelled meander loops shown in Figure 24 (Cardenas, 2008a). (a) breakthrough curves for the water exiting the downstream side of the meander loops: C^* = concentration / initial (i.e. up-stream boundary) concentration ratio; t^* = dimensionless time (= pore volume) = tV/A where t is time, V is the flux integral along the discharge line, and A is the horizontal area of the meander loop. (b) residence time distribution of solutes in the meander loop: dC^*/dt is a measure of the frequency of occurrence of residence times t . 86
- Figure 4.26** Residence times and flow path lengths for flows in the vicinity of a riffle in an effluent gravel-bed stream in Canada as modelled by Storey et al. (2003) (see also Figure 8), showing sensitivity to bed permeability and groundwater discharge (winter = twice that of summer) for (a) head difference across the riffle as in summer and (b) head difference across the riffle as in winter (= half that for summer). 87
- Figure 4.27** Chloride concentration profiles below the River Tame in Birmingham at two sites (M.O.Rivett, pers. comm., 2009). 88
- Figure 4.28** The complexity of flow paths through a three-dimensional medium-amplitude bedform as indicated by the modelling of Tonina and Buffington (2007). The pathlines all start at the sediment surface and are coloured according to pressure (Pa). 90
- Figure 5.1** Hydroecological and biogeochemical functions of the hyporheic as a mixing and transition zone between groundwater and surface water environments. 94
- Figure 5.2** Seasonal dynamics of GW/SW exchange in lowland floodplains as function of variable river-aquifer pressure head gradients with mainly surface SW infiltration into GW aquifers during wet conditions and high SW levels (left schematic) and exfiltration of riparian GW into SW during dry summer conditions and low SW levels (right schematic). 95
- Figure 5.3** A schematic representation of energy and hydrological fluxes controlling hyporheic temperature. [Total energy available at water-channel bed (Q_{bn}) interface is the sum of net bed radiation (Q_b^*), bed conduction (Q_{cd}), convective transfers (Q_{cv}), instream advective transfers (Q_{ad}), and heat stored within the bed (ΔQ_s). Chemical and biological processes are not shown, as assumed to be negligible. After Hannah *et al.*, 2009]. 97
- Figure 5.4** Relationship between the hyporheic water travel time after nitrate injection and the resulting biological uptake (open circles) and denitrification (filled triangles) during the same period. The equation corresponds to the best fit of the denitrification. (After Pinay *et al.*, 2009). 99
- Figure 5.5** Generic redox and pH conditions for attenuation or release of mining-derived pollutants within the hyporheic zone (After Gandy et al., 2007). 101
- Figure 5.6** Conceptual model of ecologically significant processes and interactions 106

between the benthic and hyporheic zones as a result of low flow and supra-seasonal drought (a) unimpaired flow and (b) low/base flow (After Stubbington <i>et al.</i> , 2009).	
Figure 6.1 Microbial loop (omitting viral component). The microbial loop is important as it reintroduces dissolved organic carbon back into the food web.	109
Figure 6.2 Depth distribution and interactions of decomposition process in buried sediments (from Jones (1985)).	112
Figure 6.3 Common methodological approaches to studying the microbial ecology of the HZ (Head <i>et al.</i> , 1999).	119
Figure 7.1 Spawning behaviour of salmonids after Soulsby <i>et al.</i> , 2001.	124
Figure 7.2 Conceptual diagram showing the complex interaction of processes that can influence salmon embryo survival. Hyporheic water quality is determined by the relative contributions of groundwater (blue) and surface water (green) which are in turn influenced by a variety of interacting physical and chemical processes. The oxygen requirement of embryos (red) interacts with oxygen availability in the hyporheic environment to determine survival. The oxygen demand of embryos depends on a combination of metabolic rate and respiring mass which is influenced by embryonic stage and water temperature. From Malcolm <i>et al.</i> , 2005.	125
Figure 7.3 Dissolved oxygen concentrations in the stream and hyporheic zone (150 and 300 mm). Discharge data are shown on the secondary y-axis (after Malcolm <i>et al.</i> , 2006).	130
Figure 7.4 a Girnock Burn discharge; temperature at (b) S16 and (c) S7; and dissolved oxygen at (d) S16 and (e) S7, for the period between salmon spawning and embryo hatch. Black lines show surface water, green lines show hyporheic water at 150 mm, red lines show hyporheic water at 250 mm. (From Malcolm <i>et al.</i> , 2009).	133
Figure 7.5 Mean alevin length ($\pm 95\%$ confidence intervals) for the nine surviving ova groups incubated at 250 mm below streambed level. The relationships between length and the mean (O) and minimum (\diamond) observed oxygen saturation levels are indicated (after Youngson <i>et al.</i> , 2004).	135
Figure 8.1 Network of mini-piezometers (PVC tubes) installed to monitor VHGs and seepage fluxes in the river (photo: Daniel Käser).	142
Figure 8.2 In-stream mini-piezometer installation on a scaffold tower. A drive-pipe fitted with a removable driving-point is hammered into the riverbed using a fence post-driver; at the required depth, the mini-piezometer is inserted in the drive-pipe, and the latter pull out by keeping the mini-piezometer in place (photo: Tristan Ibrahim).	142
Figure 8.3 Seepage flux measured using a minipiezometer and a stilling well. dh stands as the difference of level between the stream water level and the riverbed water level, and dl the length of piezometer buried in the riverbed. Vertical Hydraulic Gradient equal to dh/dl and the seepage flux is computed using the vertical component of K (K_v). In this case, as the riverbed water level is lower than the stream water level, VHG is negative and the seepage flux orientated downwards. (Source: Australian Government Department of Agriculture, Fisheries and Forestry. http://www.connectedwater.gov.au/framework/hydrometric_analysis.html).	143
Figure 8.4 Diagram of Bou-Rouch sampler using hand-piston pump. From Gibert <i>et al.</i> (2001).	146
Figure 8.5 Plan-view contour maps of the Pine River (Canada) in winter for mapped streambed temperatures (a) and vertical fluxes using an analytical solution (b). From Schmidt <i>et al.</i> , 2007.	148
Figure 8.6 Hammering of PVC tube for coring of soft riverbed sediments (photo: Nick Riess).	149
Figure 8.7 Sawing of the core in site (photo: Nick Riess).	149
Figure 8.8 Ice coring; left: core being extracted; right: frozen core (photo: Andy Quin).	149
Figure 8.9 Diagram of a perfusion core setup to assess inorganic nitrogen transformations in riverbed sediments. (D) Groundwater is evenly injected through the inlet cup (A) and flow upward in the column (B). A mixing cavity (C) is used to introduce into the column aerated recycled water using a peristaltic pump. Samples are taken from the inlet, outlet and at the sampling ports (E) along the column. From Sheibley (2003).	150
Figure 8.10 Colonization chambers. From Grant <i>et al.</i> (2007).	152
Figure 8.11 Electrical resistivity model from a cross-borehole survey. The locations of the surface and borehole electrodes are indicated by the black circles. The geological	153

logs from the core analysis of each borehole are included for comparison, and the key for these can be found at the bottom left of the figure. From Crook et al., 2008.	
Figure 8.12 Diagram showing a seepage meter installed on a bed and its collection bags attachment. Source http://edis.ifas.ufl.edu/SG060 .	154
Figure 8.13 Four designs of low-profile seepage cylinder shown with a standard half-barrel seepage cylinder made from a plastic storage drum. From Rosenberry and LaBaugh (2008).	154
Figure 8.14 Benthic macroinvertebrates sampling devices. From Storey et al. (1991).	155
Figure 8.15 a) using a soft bristle brush to remove periphyton from around a know area (photo: S. Kelly); b) known area of periphyton to be collected in to sample container (photo: Anna Ritchie).	156
Figure 8.16 Hydrograph separation on Nith River at New Hamburg, Ontario. From Neff et al. (2005).	157
Figure 8.17 Diagram of a study site design for macrophyte surveys with details of point and plot type survey schematics. From Bowden et al. (2006).	158
Figure 8.18 Adding Rhodamine WT dye to a stream. From http://toxics.usgs.gov/photo_gallery/instreams.html .	159
Figure 9.1 Flow patterns beneath riffles for different groundwater influxes. Small arrows are relative groundwater velocities; the dashed black line is a dividing streamline which separates the interfacial exchange zone from deeper zones dominated by ambient underflow or upwelling groundwater flow (Cardenas and Wilson, 2006).	168
Figure 9.2 Model spatial structures.	170
Figure 9.3 Simplified representations of river-aquifer interactions in numerical models.	171
Figure 9.4 Nested regional and local models.	173
Figure 9.5 The Eden valley river system in North West England.	176
Figure 9.6 Conceptual models of bank filtration by (a) Hantush (1965) and (b) Hunt (1999).	178
Figure 9.7 Locations of pumping and monitoring wells at the Henry bank filtration site (A) together with model grid and the vertical cross-section (B) (Ray et al., 2002).	179
Figure 9.8 (a) conceptual model of a diffuse pollution source from an upland agriculture field (b) conceptual model of mass flux from contaminated groundwater to river water through hyporheic zone in the cross-section area (Hiscock 2005).	181
Figure 9.9 (a) The location of the Nuthe basin and the observation points (numbered). (b) Plant uptake of nitrate N from groundwater in wetlands and riparian zones (Hattermann et al., 2006).	182
Figure 9.10 (a) Simulated and observed nitrate N concentrations in the Nuthe river. (b) Nitrate N coming with different pathways (with surface runoff, interflow and baseflow). (c) The uncertainty of the simulated results. (Hattermann et al., 2006).	182
Figure 9.11 River Lee Catchment area: locations and discharges of Sewage Treatment Works (STW) (Flynn et al. 2002).	183
Figure 9.12 Use of loosely coupled models to investigate the effect of groundwater abstractions on fish habitats in the River Piddle, Dorset. (a) Location map with major groundwater abstractions (1-4) and study reach. (b) Duration curves for WUA (weighted useable area, a measure of habitat availability) with and without historical abstractions (Strevens, 1999).	184
Figure 10.1 Diagram explaining habitat requirements for biotic variables used to monitor biodiversity.	194
Figure 10.2 Diagram of type A design for aquatic ledges used in stream narrowing (From RRC, 2002).	198
Figure 10.3 River Skerne after river narrowing with type-A vegetation ledges (from RRC river restoration manual).	198
Figure 10.4 Large woody debris added to a stream (From RRC, 2002).	199
Figure 10.5 Case study of boulder placement restoration. a) before restoration activities, b) after boulder placement (from RRC).	200
Figure 10.15 Photos of step-weir placement a)looking upstream, b)looking downstream.	201
Figure 10.16 Constructed riffle case study (from RRC).	202
Figure 10.17 Schematic of bund removal and floodplain connectivity (from RRC restoration manual).	203

Figure 10.18 Images from hard bank removal on the River Trent in London. a) concrete-lined channel before restoration, b) construction of riverbed and banks after concrete removal, c) natural vegetation and bank features.	204
Figure 10.19 Process of repositioning a concrete lined channel into a new riverbed, showing a) original concrete-lined channel, b) floodplain features in newly created channel, c) new channel floodplain connection, d) new channel cut through park.	205
Figure 10.20 Schematic of culvert removal and new channel creation on the River Ravensbourne.	206
Figure 10.21 Diversion of a part of the River Nith away from expanding coal excavation (RRC 2007).	208
Figure 10.22 Typical symmetrical cross-section for River-Nith diversion and lined-channel construction (RRC 2007).	208

List of tables

Table 2.1 Legislative drivers for considering GW-SW interactions.	6
Table 2.2 Summary of the key management issues that require consideration of hyporheic zone processes.	12
Table 3.1 Percentage of fine sediment in the upper 30cm of the channel bed (after Milan et al., 2000).	40
Table 3.2 Observed siltation rates for selected UK rivers.	41
Table 3.3 Fine sediment storage on the bed of selected UK rivers.	43
Table 3.4 Characteristics of fine river sediments from selected UK rivers.	44
Table 3.5 Provenance of river bed fine sediment in selected UK catchments.	45
Table 4.1 BFI value ranges for UK. Modified after Twort et al. (2000)(a) and Sear et al. (1999)(b).	52
Table 5.1 Summary of comparative physical and biological characteristics of groundwater, hyporheic and surface water environments.	102
Table 7.1 Observed critical mean dissolved oxygen concentrations during embryo incubation for various salmonids, from lab and field based studies.	127
Table 7.2. Percent survival within groups of 20 ova, observed at excavation. (Youngson et al., 2004).	134
Table 8.1 <i>Summary of monitoring techniques</i> ; largely inspired by Brodie et al. (2007) and Rosenberry and LaBaugh (2008). Techniques are roughly sorted from the coarser to the finer scale of application; the spatial scale associated with a technique is mentioned for all methods except point (or local) measurements, for which the obvious limitation is that they do not provide insight on spatial distribution unless a network of monitoring points exists. Columns C, B, FC and FQ respectively refer to the following monitoring objectives: hydrochemical sampling, biological sampling, flowpath characterization and water and solutes fluxes quantification.	160
Table 9.1. Examples of flow modelling software for the main types of models used for groundwater - surface water interactions.	186
Table 10.1 Potential direct and indirect effects of various management activities on hyporheic processes (from Edwards (1998)).	192
Table 10.2 UK River restoration techniques and their possible impacts on various factors of the GW/SW exchange.	196
Table 10.3 Summary of advantages and disadvantages of the five major approaches for evaluating restoration projects (from Roni et al., 2003, modified from Hicks et al., 1991).	211

1 Introduction

1.1 Background and objectives of the handbook

The groundwater–surface water (GW/SW) interface including the hyporheic zone, comprises fluvial sediments within which there is exchange of water between a stream and the subsurface (Bencala 2005) (Figure 1.1). It is often characterised by chemical and temperature gradients that exert control on the behaviour of chemicals and organisms both at the interface and in the adjacent aquifer and stream environments (Brunke and Gonser 1997, Hancock et al. 2005). Whilst there is a considerable body of knowledge about processes occurring within both rivers and aquifers, less is known about the processes that occur at the interface of these environmental compartments.

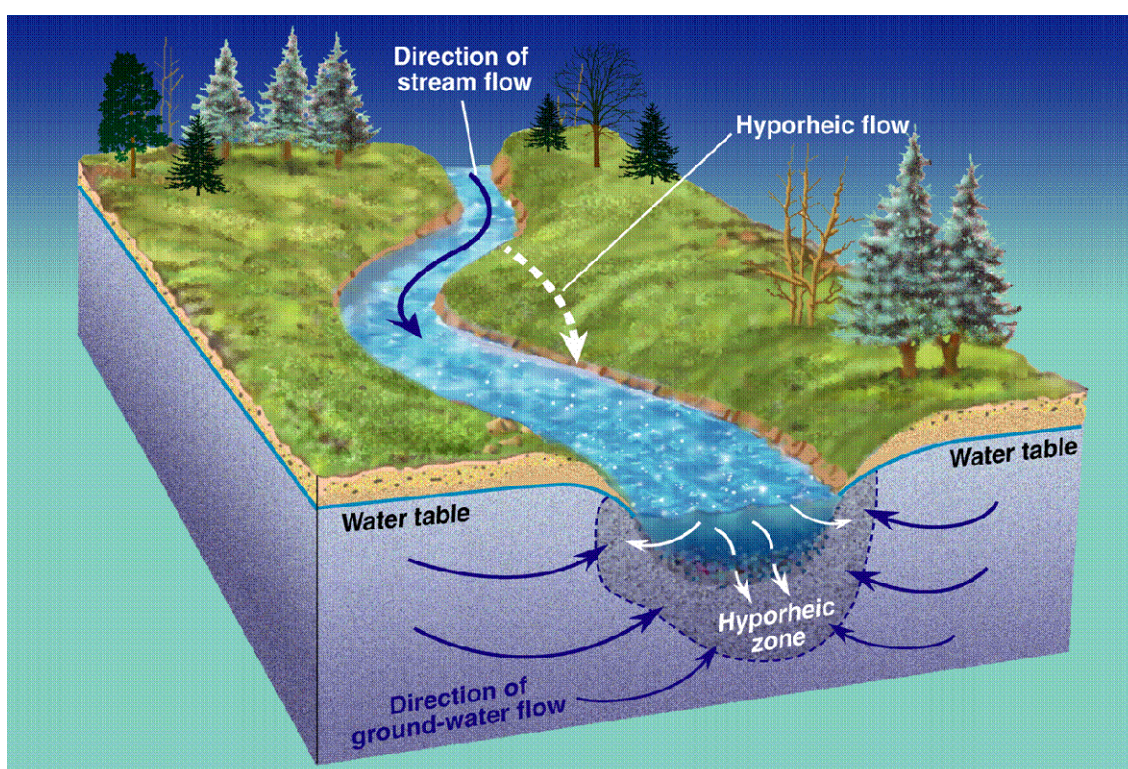

Figure 1.1 Illustrative representation of the GW/SW interface and hyporheic zone. (Reproduced with permission of USGS).

Recent developments in environmental legislation in Europe, such as the EU Water Framework Directive (CEC 2000) require a more integrated approach to the management of hydrological catchments. Similar approaches are advocated elsewhere (e.g. USGS 1998). The holistic assessment and management of catchments requires a better understanding of the interfaces between traditional environmental compartments. These interfaces were previously the boundaries of environmental management units, but are now recognised to be important areas for cycling of energy, nutrients and organic compounds (McClain et al. 2003), and exert significant control over catchment-wide pollutant transfer (Smith et al. 2009) and ecological health (Brunke and Gonser 1997).

Effective integrated catchment management requires improved transfer of knowledge from research into the science end-user community. Equally, new research priorities identified through new approaches to catchment management, site management and

legislative/policy developments need to transfer from the environmental management community to academia. Recognising these needs, the UK Natural Environment Research Council (NERC) funded a Knowledge Transfer Network on GW/SW interactions and hyporheic zone processes (The Hyporheic Network, www.hyporheic.net), between 2007 and 2009. This Hyporheic Handbook is a product of the network, and aims to bring together the latest research on a range of topics related to the GW/SW interface and hyporheic zones specifically for environmental management practitioners. The Handbook focuses principally on hydrological systems in temperate climatic zones, and applies to both headwater and larger lowland rivers.

The specific objectives of this handbook are to:

- synthesise the latest research on GW/SW interactions and hyporheic zone processes for the science end-user community, particularly river or catchment managers
- transfer knowledge from the research base to the science end-user community
- provide a 'how to', or at least 'what to think about', handbook to encourage the use of sound science in river management decisions
- provide a teaching aid for post-graduate level students.

The first section of this handbook provides an overview of GW/SW interactions and hyporheic zone processes, then reviews the environmental management issues that require the GW/SW interface to be considered. Subsequent chapters bring together the latest research on specific aspects of the interface, and cross reference to the environmental management questions. The handbook concludes with recommendations for further work in both research and environmental management fields.

1.2 Why is the groundwater–surface water interface important?

The GW/SW interface is the transitional zone between the subterranean and surface aquatic environments and it provides a number of ecological goods and services, including:

- controlling the flux and location of water exchange between stream and subsurface
- providing a habitat for benthic and interstitial organisms
- providing a spawning ground and refuge for certain species of fish
- providing a rooting zone for aquatic plants
- providing an important zone for the cycling of carbon, energy and nutrients
- providing a natural attenuation zone for certain pollutants by biodegradation, sorption and mixing
- moderating river water temperature
- providing a sink/source of sediment within a river channel.

Assessing the processes occurring at the GW/SW interface is critical when estimating and quantifying water and contaminant fluxes throughout a catchment, and when assessing and protecting river ecosystems. The full range of ecological services needs to be considered when assessing an individual river, although certain ecosystem services are likely to be more important than others in different types of river.

Assessment of the condition of water bodies across the European Union has confirmed that the major pollution causes of poor chemical and ecological status are nutrients (nitrogen and phosphorus) from agriculture and sewage effluent discharges, metals from mining activities and organic pollutants, including pesticides, chlorinated solvents and petroleum hydrocarbons (fuel components). Processes at the GW/SW interface have been shown to naturally attenuate a number of these EU Water Framework Directive priority pollutants, and consequently there is a need for further investigation of the potential for pollutant natural attenuation, its spatial and temporal heterogeneity, and management screening and assessment techniques.

Similarly, over-abstraction of groundwater has been shown to deplete rivers and cause ecological harm associated with low-flow conditions. The import of sediment into rivers causes siltation (colmation) of the bed sediments at the GW/SW interface that is detrimental to fish spawning success. The range of ecological services needs to be assessed along with factors which might affect how they function, so that surface water bodies can be protected and restored where necessary.

Current catchment-scale models of environmental processes are often inaccurate when compared with field observations. This is partly due to a lack of data and process understanding, and partly due to simplification in catchment conceptual models, which frequently exclude certain processes and zones, including the GW/SW interface. Smith et al. (2009) showed how including the GW/SW interface in catchment-scale river nitrate pollution predictions improved the accuracy of predictive modelling used to designate protection areas, such as Nitrate Vulnerable Zones. Similarly, omitting processes at the GW/SW interface when designing river restoration schemes may cause the project to fail, with no significant improvement to ecosystem health. For example, Jarvie et al. (2005) showed how riverbed sediments may act as a long-term source of phosphorus to rivers, thereby potentially diminishing the short to medium-term benefits delivered by improvements aimed at improving the quality of discharges from sewage treatment works.

1.3 How can the hyporheic zone be damaged?

The hyporheic zone is temporally and spatially dynamic, often exhibiting continuous changes in chemical and physical conditions. Human actions can severely damage the sediment structure, or the hydrological, chemical or biological conditions within them. Later chapters deal with a range of ecological goods and services that the hyporheic zone provides and which can be unnecessarily degraded by poorly considered management actions. For example, the following (legitimate) activities have consequences that should be evaluated within management decisions:

- Dredging: removes sediment (potential habitat); removes natural attenuation capacity; may preferentially remove gravel (spawning grounds);
- Weirs and impoundments: alter the river power around the structure, leading to deposit of fine sediments up-stream of a weir and blinding of riverbed sediments;
- Land-management: erosion of soil from agricultural land is a major source of fine sediments and nutrients in rivers, which can cause colmation and eutrophication;
- Flood-defence: construction of flood barriers (e.g. concrete river walls) has greatly reduced river – floodplain connectivity and degraded the ecological integrity of both riparian and hyporheic environments;

- River restoration: seeks to enhance and improve a degraded river reach, but in the past many restoration schemes have focused on achieving a limited range of benefits (often just aesthetic improvement such as putting bends back into a channelised watercourse). Designers of river restoration schemes should consider how the works might be developed to improve the full range of ecological goods and services, including hyporheic habitat, GW/SW exchange and vertical connectivity. Restoration schemes that fail to think in three-dimensions (and beyond the immediate extent of the river channel) are likely to fail to achieve the optimum benefits that could be accrued by good design.

1.4 Conceptual models

Conceptual models of the GW/SW interface, the hyporheic zone and the processes occurring within them have been developed by workers in a number of different fields (Figure 1.2). The different research backgrounds of the researchers means that there is variation in the definitions and metrics used for parameterisation (Bencala 2000). Many authors have failed to clearly define how they have distinguished between the GW/SW interface and what they term the hyporheic zone, and a better description of the latter (whether considered a zone of active water exchange, presence of a characteristic hyporheic ecology, or biogeochemically active zones) would help communication between different scientific disciplines and with river managers, which is ultimately necessary for communication with wider stakeholder groups and decision-makers (Smith et al. 2008). In this handbook the GW/SW interface is taken to be the fluvial riverbed sediments through which there is exchange of water (over any time period) between a stream and geologic media. The hyporheic zone is that portion of the fluvial sediments in which there is exchange of water from the stream into the riverbed sediments and then returning to the stream, within timescales of days to months.

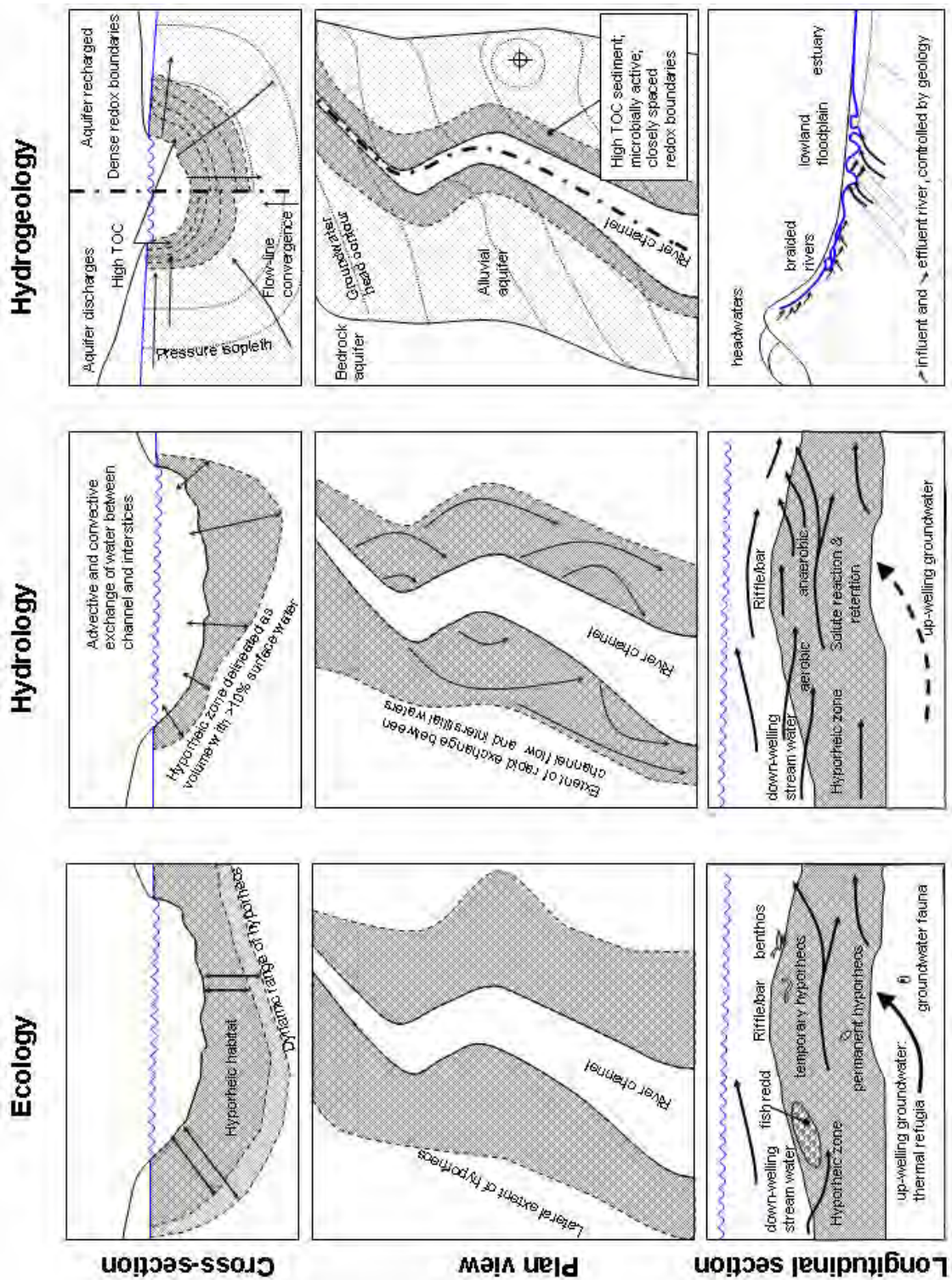

Figure 1.2 Illustrative conceptual models of the GW/SW interface and hyporheic zone commonly assumed in differing scientific literatures (after Smith, 2005).

2 Environmental management context

2.1 Legislative drivers

A number of legislative and regulatory instruments require the GW/SW interface to be considered in order to be fully and effectively implemented. Table 2.1 summarises the legislative drivers relevant in the European Union, and the UK.

Table 2.1 Legislative drivers for considering GW-SW interactions.

<i>Environment management theme</i>	<i>European Union Directives</i>	<i>UK level legislation</i>
Water resources management	Water Framework Directive 2000	Water Act 2005; Water Resources Act 1991
Water pollution	Water Framework Directive 2000 Groundwater Directive 2006 Nitrates Directive 1994	Environmental Protection Act 1990; Water Resources Act 1991; Groundwater Regulations 1998
Conservation	Habitats Directive 1992	Conservation (Natural Habitats) Regs 1994
Contaminated land	Water Framework Directive 2000	Environmental Protection Act (Part IIa) 1990; Town & Country Planning regime
Environmental monitoring	Water Framework Directive 2000 Groundwater Directive 2006	Water Resources Act 1991; Environment Act 1995
Flood risk management	Water Framework Directive 2000	(Draft) Floods and Water Bill; Defra Water Strategy – Future Water

2.2 Legislative and management context

2.2.1 Catchment management

Until recently most regulatory and management approaches to environmental protection have focussed on particular environmental compartments, or industry/activity sectors. Consequently, effort has been directed towards understanding the behaviour of water and pollutants in aquifers (for example in Europe to develop the science needed to implement the EC Groundwater Directive (Council of the European Community (CEC) 1980) or on the behaviour of pollutants within rivers, which was necessary for implementation of the Dangerous Substances Directive (CEC 1976). The policy development, scientific research and management of aquifers and rivers were largely undertaken by separate groups within the respective organisations. Rivers and aquifers were often considered as separate, essentially unconnected, systems.

The EU Water Framework Directive (WFD) (CEC 2000) came into force on 22 December 2000 and established a new legislative regime for the integrated management, protection and improvement of Europe's rivers, lakes, estuaries and groundwater. It sets out a series of environmental objectives that must be met within defined timescales. The initial characterisation of water bodies and economic analysis of water usage was completed in December 2004.

Following a further series of defined stages, a River Basin Management Plan (RBMP) and a programme of measures specific for each water body must be prepared by 2009. Further characterisation, review of the effectiveness of the programmes of measures

and updated RBMPs are then to be produced on a six-yearly rolling programme. Environmental objectives, including good status objectives for all water bodies, must be met, where feasible, by the end of the first river basin planning round in 2015.

The status of a surface water body is determined by the poorer of its chemical or ecological status. Chemical status is determined by compliance against water quality standards prescribed by the European Commission, while ecological status is a measure of the anthropogenic impacts on a water ecosystem. Ecological status is determined by comparison of current ecological conditions against 'reference conditions' that would exist in a pristine surface water body of similar type (altitude, geology, size, etc.).

The development of practical and comprehensive methods to determine the ecological status of surface water bodies is not straightforward. The ability to transfer approaches between rivers and streams, headwaters and lowland rivers, and naturally oligotrophic and nutrient-rich systems, needs to be considered. The interactions between chemical concentrations and ecological health are unclear. Current approaches to determine river ecosystem health are generally based on investigation of the benthic invertebrate community. Assessment methods that include hyporheic organisms have not been developed (Boulton 2000) and the fundamental understanding of ecosystem response to specific pollutant concentrations within a complex and dynamic environment is poorly developed.

Groundwater status is determined by the groundwater chemical status and groundwater quantitative status. Methods to assess groundwater chemical status are covered by the 2006 Groundwater Directive (CEC 2006). The interactions between groundwater and surface water bodies is an important aspect that needs to be understood to properly assess the impacts of pollutants in groundwater on dependent surface waters, and vice versa. The WFD requires that groundwater bodies and surface water bodies be managed in an integrated manner, together with other protected areas, such as designated wetlands (called 'groundwater-dependent terrestrial ecosystems' in the WFD) (Figure 2.1). The processes that control water flow, pollutant migration and ecological response at the interface are vital to this assessment and are poorly understood.

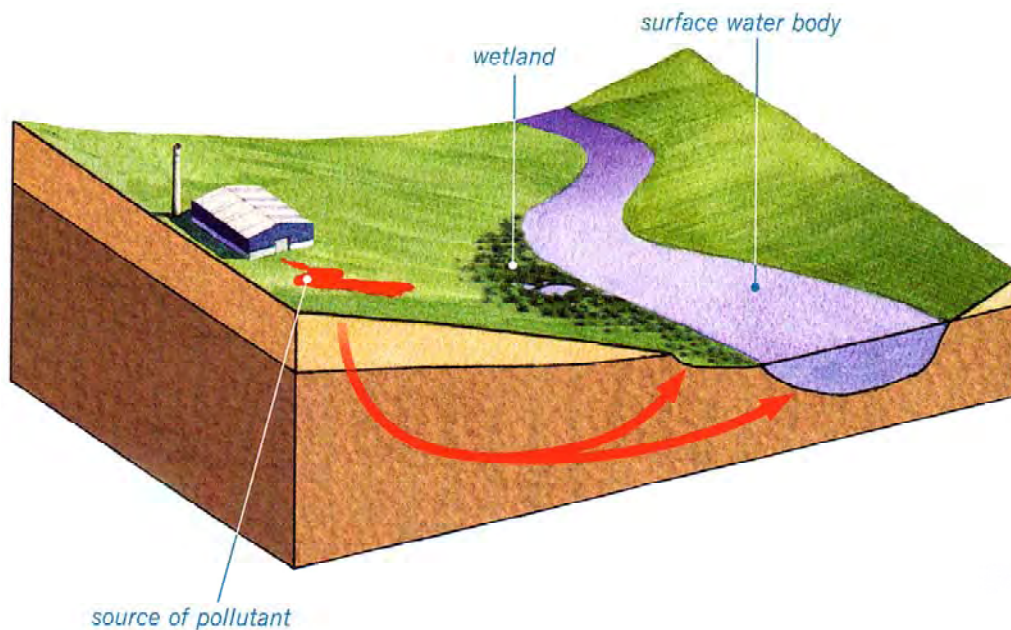

Good groundwater chemical status requires that the concentrations of pollutants in groundwater would not cause significant damage to the ecological quality of a surface water body or to a terrestrial ecosystem, such as a wetland.

Figure 2.1 WFD requires assessment of GW/SW interactions (after Environment Agency 2002).

Groundwater quantitative status is a measure of the sustainability of water use, in terms of balancing human and ecological needs for water. With regard to GW/SW interactions, the principal topics of interest are the controls it imposes on flow across the interface (and implications for quantitative status), pollutant natural attenuation that limits chemical fluxes between the adjacent water bodies, and the condition and response of hyporheic ecology as a component of river ecology.

Groundwater – river interactions are also an important consideration in fluvial geomorphology, including management issues such as flood risk management, dredging and navigation, and river restoration. Geomorphologic conditions in rivers influence the habitat quality of the sediments and the water exchange patterns. Activities that modify the geomorphology, such as dredging, or disconnect a river from its riparian flood plain, such as engineered river banks for flood protection, inevitably damage the quality and diversity of ecological goods and services provided by the GW/SW interface, or remove sediments that might otherwise have provided natural attenuation capacity. River restoration schemes have the potential to improve GW/SW connectivity and hyporheic zone habitat provision, but relatively few schemes have explicitly considered GW/SW exchange processes in their design (Boulton 2007).

Following the 2007 floods in the UK, a government review (the Pitt Review) was undertaken as part of a renewed focus on fluvial and surface water flooding. The review has informed a new strategy 'Future Water' (Defra, 2008) and a draft Floods and Water Bill that will drive a more holistic and integrated approach to catchment management in terms of flood and water resource. The role of the interface (including the riparian zone) as a buffer for flooding, and as part of a reconnected river - floodplain continuum will help to ensure more sustainable management of water resources both at high and low flow.

The Water Framework Directive has changed the emphasis for environmental protection and established a requirement for a more holistic and integrated approach to catchment management (Environment Agency 2002). Groundwater and surface water bodies can no longer be managed in isolation. Understanding the processes that occur at the interfaces of environmental compartments, including the GW/SW interface, has become vital in order to assess risks associated with the transport of water and pollutants through catchments, their effects on ecosystem function, flood risk mitigation and to design effective restoration strategies.

2.2.2 Site-specific environmental risk assessment

The great majority of contamination risk assessments undertaken by landowners or regulatory bodies are site-specific and at plot- or pollutant plume-scale, rather than catchment scale. Most assessments are undertaken as part of corporate liability management, in preparation for the redevelopment of brownfield sites, or to assess sites and/or processes that could pose a pollution hazard. A tiered approach to environmental risk assessment is recommended in the UK (DETR et al. 2000), and most environmental risk assessments follow a *source–pathway–receptor* analysis method. This approach seeks to identify the nature of hazards (the source), the entities that could be harmed or polluted (the receptors) and the routes by which the receptors could be exposed to those hazards (the pathways), and to understand the likelihood and consequences of exposure.

The *source–pathway–receptor* approach has been restricted to certain environmental compartments (e.g., pollutant behaviour processes within an aquifer) or site boundary limits (assessing risks associated with contaminants under a piece of land, but ignoring surrounding land owned by others). This was initially as a result of environmental regulation, but has become increasingly common through corporate management because of liabilities associated with both financial and legal risks. The Environment Agency's recommended approach for assessing the risks from contaminated soils to controlled waters (Environment Agency 2006) includes the assessment of groundwater pollutant plumes on surface water bodies. However, in reality, in-river dilution and attenuation is rarely applied, and compliance is generally assessed at an arbitrary compliance point up gradient of the surface water receptor (Point A, Figure 2.2). The latter generally occurs as a result of reluctance on the part of problem holders to investigate riparian and/or hyporheic processes on land that they do not own, and a lack of awareness of the natural attenuation capacity that may exist in the near-river environment. In some large lowland rivers the sorption potential of riverbed sediments far exceeds that of the adjacent aquifer (Smith and Lerner, 2008), while others have identified natural attenuation processes to be important in the biogeochemically active GW/SW interface for nitrate (e.g. Fischer et al. 2005), chlorinated ethenes (e.g. Bradley and Chappelle 1998; Conant et al 2004), metals from mining (Gandy et al. 2007) and fuel hydrocarbons (Bradley et al. 1999, 2002; Landmeyer et al. 2009).

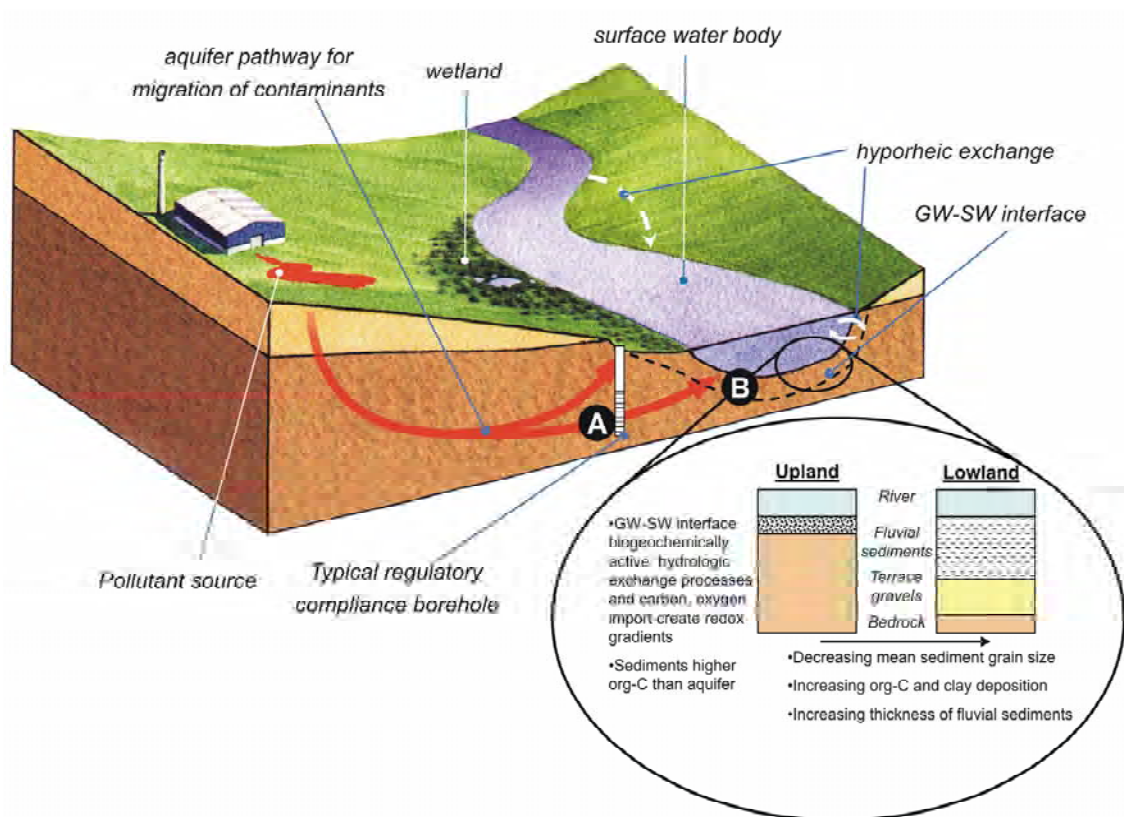

Figure 2.2 Typical contaminated-site assessment using the *source–pathway–receptor* framework. Use of a compliance-monitoring borehole adjacent to the stream (A) excludes any potential attenuation at the GW-SW interface (B) (after Smith & Lerner, 2008, based on Environment Agency, 2002).

Understanding environmental interfaces, such as those at the GW/SW boundary, will be critical for effective catchment management. The GW/SW interface, and specifically the hyporheic zone, has been described as having a pivotal role in the functioning of river ecosystems (Palmer 1993), but it is probably unknown to the great majority of experts in the management of agricultural and contaminated land.

2.3 Environmental management questions

The GW/SW interface plays an important role in catchment functioning, however from an environmental management perspective, the interface can often be considered in the context of a limited number of broad environmental management themes. These can be classed as:

1. Sustainable management of water resources
2. Protection and improvement of water quality
3. Protection and improvement of lotic ecology

Cutting across these themes are management issues such as:

4. Environmental monitoring and investigation
5. Risk assessment, modelling and forecasting
6. Restoration and remediation

Table 2.2 summarises typical environmental management question(s) that may need to be answered within each theme, and the most relevant management regimes in the EU

or UK are also shown. Directions are given to later chapters of this handbook, where further detailed information relevant to each issues is presented. The various aspects subsequently need to be considered holistically at the end as part of integrated management.

Chapters 3 – 10 present reviews of the latest science on various aspects of the GW-SW interface. Chapter 11 highlights key issues that river managers ought to consider when assessing the risk to, or functioning of, the GW-SW interface.

Table 2.2 Summary of the key management issues that require consideration of hyporheic zone processes.

Issue	Management question	Key management context(s)	Information in this document
Sustainable management of water resources			
1	How do GW/SW interactions vary spatially and temporally and what are the impacts of regional groundwater abstraction on water balances at water body scale?	regional water resources strategies, Catchment Abstraction Management Strategies (CAMS)	Chapters 3, and 4
2	Where do GW/SW exchanges occur, and what are the likely impacts of climate change scenarios on GW/SW exchange and catchment water budgets?	regional/national climate change adaptation strategies	Chapters 3 and 4
3	How does local abstraction of groundwater affect the water levels and/or discharge in a nearby stream or wetland?	abstraction licence determination	Chapter 4
4	Where does GW discharge to SW occur under high flow conditions, and how significant is it in terms of GW flooding risk?	flood risk management / mapping	Chapters 3 and 4
5	Where does GW discharge to SW occur under low flow conditions, and how significant is it in terms of stream flow/ecosystem resilience to drought?	drought management	Chapters 3 and 4
6	How can we best represent the GW/SW interface in water resource models, and what data requirements does this imply?	regional water resources strategies, CAMS	Chapters 4 and 9
Protection and improvement of water quality			
7	Where does GW/SW exchange occur and how does it affect the location of pollutant exchange?	pollution prediction / management	Chapters 4 and 5
8	How important are, and what are the local controls on, riverbed natural attenuation (NA) processes on the flux of a point source groundwater plume moving towards a river?	contaminated land / GW risk-management	Chapter 5
9	How important are riverbed NA processes on the flux of diffuse GW pollutants discharging to rivers, and how do they vary at catchment scale?	land-use management e.g. NVZ designation	Chapter 5

10	How important are riverbed NA processes on the flux of river pollutants infiltrating into groundwater?	bank filtration schemes; groundwater resource management	Chapter 5
11	What effect do sediment properties / natural attenuation processes have on the flux of acute river pollutants infiltrating into groundwater? and where is the threat to GW resources greatest?	river pollution incident management	Chapter 5
12	Do hyporheic exchange processes (stream – HZ – stream) improve river water quality at the SW body scale, and if so how important are these process on river concentrations?	pollution prediction / management	Chapter 5
Protection and improvement of lotic ecology			
13	How do patterns of GW/SW exchange affect the success of fish spawning?	fisheries management	Chapter 7
14	How do patterns of GW/SW exchange affect the distribution and diversity of epibenthic / hyporheic fauna?	ecology management	Chapter 6
15	How does siltation and other modification of substrate conditions affect the health of fisheries?	fisheries management	Chapter 7
16	What is the biodiversity in hyporheic zones in UK rivers, and how does it vary at SW body scale?	conservation strategies / habitat protection	Chapter 6
17	What ecological functions, goods and services does the GW/SW interface provide to the wider environment and can we place a value of those benefits?	putting GW-SW in an ecosystems-centred management system	Chapter 6
18	How does local abstraction of groundwater affect the water levels and discharge in a nearby stream or wetland, and will it have a detrimental effect on the ecology?	abstraction licence determination	Chapters 4 and 6
19	Does polluted groundwater discharge affect hyporheic and stream ecology, and which species are most vulnerable?	pollution risk management	Chapters 6 and 7
20	How do natural variations in fluvial geomorphology and riparian zone structure influence the ecology of the GW/SW interface and river?	understanding natural variability	Chapters 6 and 7
Environmental monitoring and investigation			

21	What are the best / cheapest / most accurate (etc) methods to sample / monitor: I. GW/SW exchange (incl. location and flux); II. Stream flow accretion/loss due to GW discharge/infiltration; III. Pollutant flux and NA processes across the GW/SW interface; IV. Hyporheic zone biodiversity (particularly invertebrate); V. Hyporheic fauna to measure stream health / integrity ('biomonitors').	monitoring to support all environmental management	Chapter 8
Risk assessment, modelling and forecasting			
22	Is the GW/SW interface a source, pathway or receptor in a S-P-R risk assessment, and does it vary between rivers?	Environmental (normally contaminant) risk-assessment	Chapters 4 and 9
23	What are the most appropriate criteria for assessing damage to hyporheic zone ecosystem function?	Ecological evaluation and protection	Chapter 6 and 7
24	What conceptual model best describes the GW/SW interface, and processes therein?	Environmental risk assessment	Chapter 9
25	Which numerical models best represent the conceptual understanding of the GW/SW interface?	Modelling and prediction	Chapter 9
26	Do the available numerical models provide predictions at spatially and temporal resolution to be of use in decision-making?	Assessing confidence in predictions	Chapter 9
Restoration and remediation			
27	What ecological services does the HZ provide and why should vertical connectivity be designed into a river restoration scheme?	Specifying restoration objectives	Chapters 6, 7 and 10
28	How much 'healthier' / 'better' will a river be if restoration design addresses vertical connectivity?	Integrated catchment management	Chapter 10
29	How should the ecological (particularly hyporheic zone ecology) objectives for hyporheic zone restoration be specified, and how should they be monitored to demonstrate if the works have achieved those goals?	Measuring restoration success	Chapters 8 and 10
30	What are the priority ecological services at the GW/SW interface to attempt to restore, and do they vary spatially and temporally?	Specifying relevant restoration objectives	Chapter 10

3 Geomorphology and Sediments of the Hyporheic Zone

3.1 Summary of key messages

1. **Geomorphological impacts on hyporheic zones are readily apparent** at multiple and linked spatial and temporal scales. In particular, sediment, nutrients and contaminants delivered to a site from hillslopes or upstream reaches are important for the stability, disturbance and maintenance of hyporheic zone habitats, therefore site-specific approaches to management are much less likely to succeed. A catchment approach is therefore essential.
2. **River channel and basin histories are important to the understanding and management of hyporheic zone.** For example, channel materials in upland glaciated areas of northern and western UK tend to be coarse, with higher hydraulic conductivities and increased potential, at least, for flow and pollutant exchange between surface water and groundwater. Reaches located immediately upstream of transverse valley moraine features of low permeability can often be associated with strong groundwater upwelling.
3. **UK rivers tend to become more dynamic and unstable from SE to NW,** and this will affect hyporheic exchange flows and channel stability: this is important for river restoration design. Catchments in northern and western Britain often show greater annual precipitation, rainfall seasonality and storm magnitude/frequency; higher absolute river discharges and specific runoff; steeper stream longitudinal profiles and hillslopes; and thicker covers of loose, erodible glacial materials linked to recent glacial conditions.
4. **Rivers undergo strong downstream changes in channel geometry, energy and materials,** and new data and models are changing our view on such longitudinal processes. However, few attempts have been made to predict the impacts of such longitudinal changes on hyporheic zone operation. However, it is becoming possible to classify expected geomorphologic characteristics of channel segments depending on location in the river network and catchment and their associated potential for hyporheic exchange. In a downstream direction river channel width increases preferentially over depth, so river banks may play a more important role in hyporheic exchange flows in upper reaches where they occupy a greater fraction of the channel perimeter. Stream power can be a useful measure of channel instability and bedload transport, but power (and possibly channel instability) can peak in *intermediate* locations river systems, where the optimum combination of slope and discharge is achieved.
6. **At reach scales, hyporheic exchanges are driven primarily by topographic features and changes in bed permeability.** Geomorphologic features lead to variable pressure gradients by three mechanisms: (a) by inducing vertical hydrostatic head gradients; (b) by inducing horizontal hydrostatic head gradients; and (c) by inducing dynamic head gradients due to current-topography or current-obstacle interactions.

7. **Riffles are common bedforms in rivers and are especially important for hyporheic exchange flows** and zones of upwelling and downwelling. Spacing of riffles varies in the UK from 3-21 channel widths.
8. **Any topographic irregularity (e.g. a meander bend) induces hyporheic exchange.** This process drives surface water-ground water connection at channel-floodplain to alluvial valley scales.
9. **At site scales (for example an individual riffle or pool), the topography and sedimentology also impact on hyporheic water and nutrient exchanges,** but topographic features generally result in shallower penetration of surface water and shorter flow paths than exchanges driven at the reach scale. Streambed obstacles (such as log jams or boulders) cause pressure differentials that induce surface-subsurface water exchange.
10. **Variability in hydraulic properties of riverbed sediment can also induce hyporheic flow,** even in the absence of pressure gradients along the river-sediment interface. Yet limited monitoring means that the national extent of river siltation in the UK is poorly understood. However, variability is high between and within streams and reaches (sub 1-mm fraction can vary from 1% - 70%), and it changes seasonally (sedimentation rates often peaking in winter), so generalisation is difficult. Site-specific surveys over periods longer than one year are therefore recommended.
11. **The process by which fine sediment moves into gravel beds is termed *colmation*.** Such sediment infiltration processes are best considered in two groups: (a) those acting in the water column, such as gravitational settling and turbulence, which deliver fine sediment to pores in the upper surface of the deposit; and (b) those acting within the sediment to redistribute material delivered to surface pore spaces. If *fine* sediment (e.g. sub 1-mm) is significantly present in the bed (e.g. >14% of total sediment) negative ecological impacts can result (e.g. for spawning).
12. **High flows can cause fine sediment to settle more deeply into the bed.** When flows increase sufficiently to disturb the bed framework (such as when critical stream powers or shear stresses have been exceeded) pore spaces dilate and fine sediment, if not scoured, is able to penetrate deeper into the bed gravels.
13. **In many streams, fine sediments are associated with organic material** associated with vegetation growth or logging activities. This is important because the process of oxidation of organic matter creates a Sediment Oxygen Demand (SOD) within the spawning gravels that directly competes with the incubating eggs.
14. **Sediment processes in gravel river beds can be modelled.** *Empirical* models aim to predict fine sediment accumulation in redd gravels from field measurements and extrapolation over time, or predict from a series of empirical relationships that broadly represent sediment transport, infiltration and egg survival. *Analytical* models, though (for example Sediment Intrusion and Dissolved Oxygen: SIDO), predict near-bed sediment concentration and the infiltration process. SIDO models the processes of sediment transport and infiltration into a static salmonid redd (composed of different grain sizes), the supply rate of oxygen transported through the gravel bed, egg oxygen consumption and temperature dependence.
15. **The *quality* of fine sediments is particularly important,** especially any associated pollutants and organic fractions. Fine bed sediments play an important role in the temporary storage or fate of nutrients and pesticides and other contaminants. Hence predicting pollutant attenuation capacities of hyporheic sediments are seen as an increasingly important area in environmental management.

3.2 Introduction

Geomorphological and sedimentological structure of river channels is crucial to hyporheic zone operation. Typically, water within the hyporheic zone is composed of upwelling groundwater and advected surface water. The influx of water from these zones is controlled by dynamic processes operating over a variety of spatial and temporal scales. In complex landscapes, hyporheic exchanges are typically composed of localised hyporheic processes embedded within larger hillslope groundwater systems (Malard & Hervant, 1999). At smaller scales, the riverbed can be viewed as a mosaic of spatially distinct surface-subsurface exchange patches in which the timing and magnitude of exchange is temporally variable (Malard & Hervant 1999).

Catchment geomorphology can express much of this complexity, and is one of four primary controls of hyporheic exchange flow, HEF (see Chapter 4), alongside stream water level, groundwater discharge and hydraulic conductivity (linked to grain size and shape distributions, sediment unit weight and bedrock outcropping). Indeed, a recent classification of pollutant attenuation abilities of hyporheic zones by Booker et al. (2008) is based on sediment thickness, sediment permeability, subsurface permeability and geochemistry. A further two variables are used in the derivation of these properties: stream power (see section 3.4.4) and sediment supply. The method can be used to focus resources for further investigations on areas with specific types of hyporheic zones. The method can also be used to further characterise water bodies for EU Water Framework Directive purposes.

Thus, there is an increasing interest in the role of geomorphology and sediments in the operation of the hyporheic zone (e.g. Sear et al., 2008; Cardenas, 2009). However, 'we know little regarding how geomorphological features along the surface-groundwater interface collectively affect water quality and quantity' (Cardenas, 2008, para 1), and we are probably not yet at the stage where channel morphology and sediments can be used to predict HEF.

The aim of this chapter is to review the roles of geomorphology and sediments relevant to fluvial and hyporheic zone processes. Though we draw on a large range of literature, references have been kept to a minimum to make the chapter more readable. The main focus lies with humid temperate environments typical of UK hydrological systems, given the principal target readership of this Hyporheic Handbook. Clearly, basin and fluvial processes exert strong control over hyporheic zone dynamics and ecology at many spatial scales (e.g. catchment, reach, site or bedform) and at long-term, annual, seasonal and storm-event timescales. Figure 3.1 establishes a holistic drainage basin context and nested spatial scales, with particular reference to sediment supply.

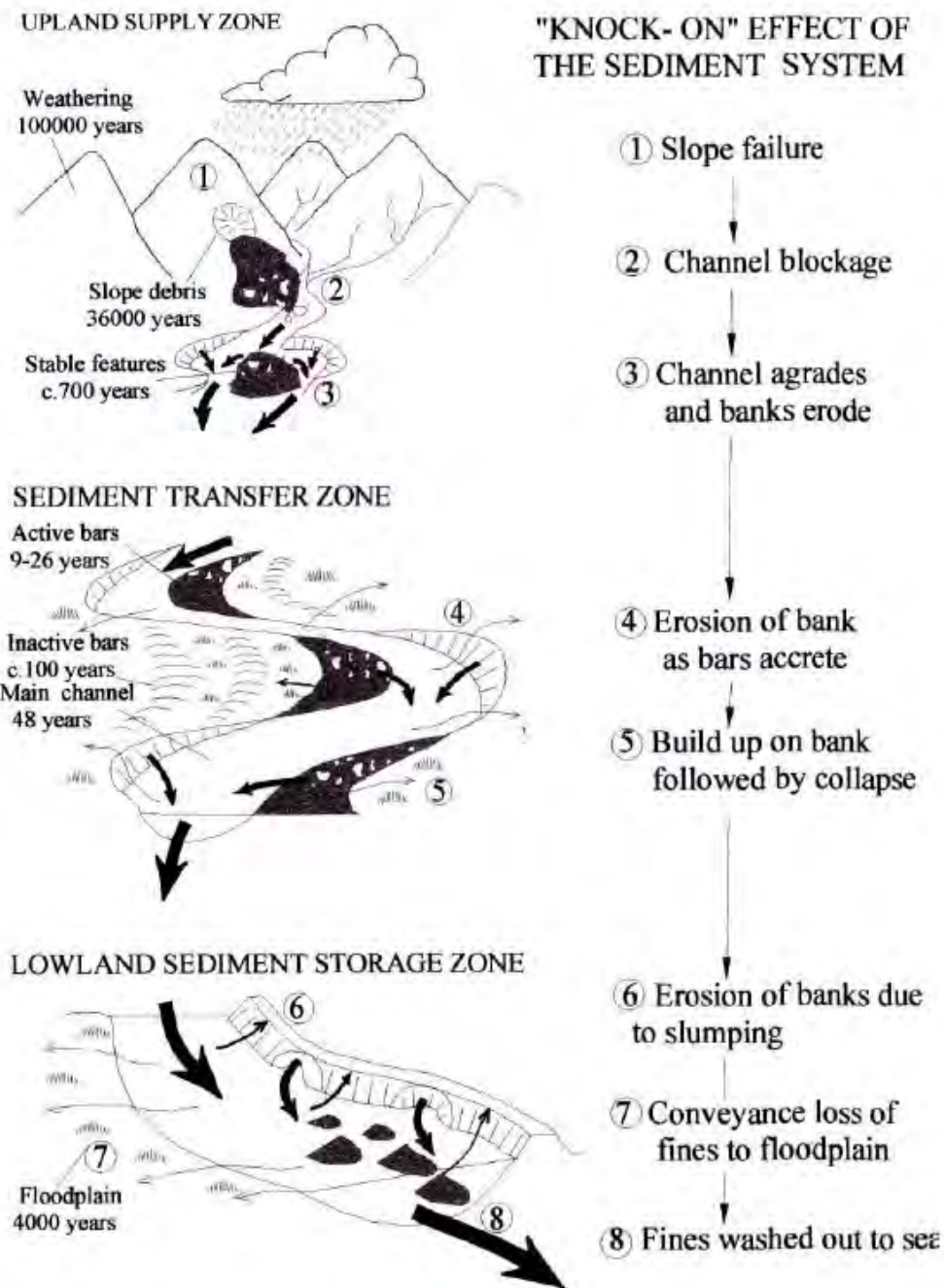

Figure 3.1 Sediment supplies and connections in a catchment context (Sear et al., 2004).

This chapter uses scale as a framework: it begins with longer-timescale issues relevant to valley fills and river bed material, moves to basin scale processes, and finishes with a consideration of geomorphologic processes at reach and site scales, and at storm-event timescales. For example, at catchment scales, long profile gradients and drainage network properties influence channel hydraulics and bedform and habitat creation at smaller scales. Catchment surface and subsurface runoff, erosion, basin-channel connectivity, and delivery of sediment, organics and contaminants to stream channels and hyporheic zones are crucial to fluvial suspended sediment transport, sediment ingress and habitat quality.

At reach scales, bedforms (for example pool-riffle sequences) influence the rate and periodicity of downwelling (mainly at riffle heads) and upwelling (mainly at riffle tails). Channel planform drives flow structures and velocity distributions important for sediment transport continuity and redistribution of bed sediment. At site scales, sediment characteristics (such as channel substrate architecture, particle size and shape distribution, pore geometric properties and connectivity, armour development and roughness) impact on hyporheic water and nutrient exchanges. Channel geometry (such as wetted perimeter and width/depth ratio - and therefore shading potential) influences the lateral and vertical extent and thermal cycling of the hyporheic zone.

Furthermore, scales are linked: sediment, nutrients and contaminants delivered to the channel from basin- or reach-scale processes through hydrological, fluvial and geotechnical processes (for example gully, bed and bank erosion; Lawler, 2008) are important for the stability, disturbance and maintenance of hyporheic zone habitats as expressed by the intermediate disturbance hypothesis. Infiltration of sediment into bed gravels (colmation) is especially important, and this is influenced strongly by transport dynamics (Lawler et al., 2006) and properties of both the substrate and fine sediment (see section 3.7).

One brief example serves to illustrate the effects of scale here. Baxter and Hauer (2000, p. 1470) demonstrated the importance of considering 'multiple spatial scales within a hierarchical geomorphic context' in their findings. They found that at the reach scale, bull trout selected *upwelling* zones for spawning, but within these reaches, trout chose localised *downwelling* zones of high intragravel velocities in transitional bedforms to establish redds.

3.3 Long timescale impacts: valley materials and geomorphology materials

3.3.1 Devensian background and valley materials

The evolution of valley fills is important in that it impacts on the sedimentology and geomorphology of the GW/SW interface. For example, Soulsby et al. (2005, p.39) found that groundwater often entered stream channels via drift deposits in valley bottom areas, which were fed from recharge areas on the catchment interfluvies. Indeed, a range of groundwater sources which reflected complex solid and drift geology accounted for spatial differences in stream hydrochemistry and the spatial delineation of groundwater discharges to rivers and riparian zones.

In the UK, there are clear differences in valley fills and channel materials depending on the compounded variables of recent glacial history, source materials, elevation and slope, and these influences are significant in the operation and management of hyporheic zone processes. Figure 3.2 shows the limits of ice advance for the last glaciation. Rivers to the north and west of the glacial limit tend to be sourced at higher altitudes which are cooler and receive substantially more precipitation, and with a higher snow percentage. Floodplain, river bed and bank materials are likely to be coarser (angular gravels are common), and these are likely to increase hydraulic conductivity and therefore HEFs (see Chapter 4).

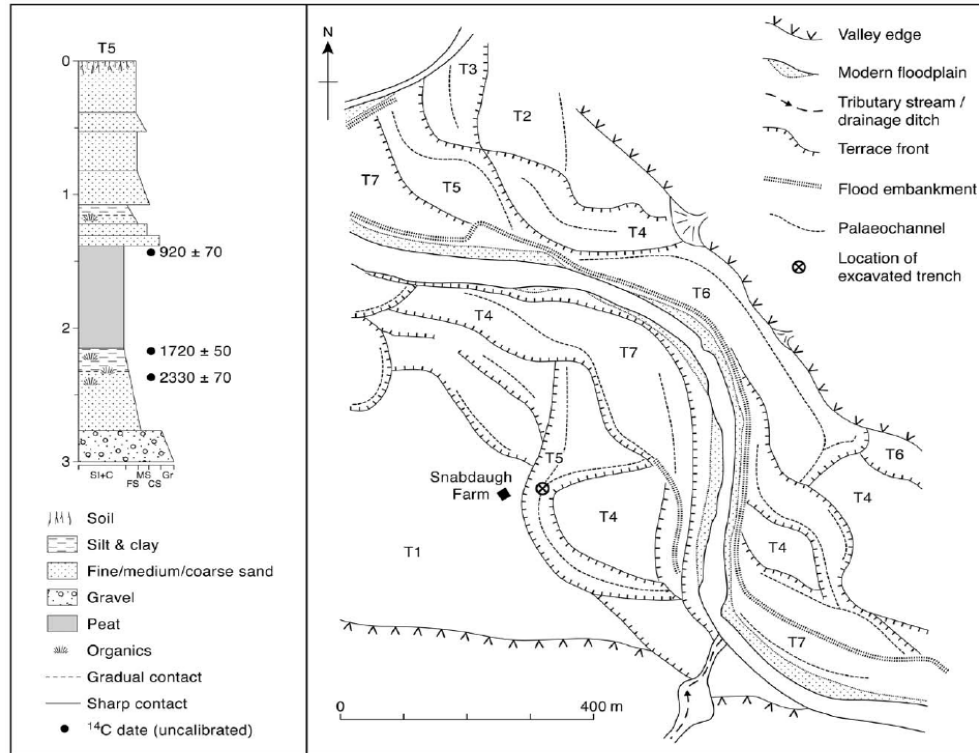

Figure 3.3 Complexity of valley fills: example of the River North Tyne (Lewin et al., 2005).

In particular, the presence of valley fill gravels can provide a focus for upwelling groundwaters. Furthermore, areas where groundwaters enter the stream channel directly can have profound ecological implications; 'most obvious are low rates of salmonid egg survival where chemically reduced groundwater discharges through the hyporheic zone' (Soulsby et al., 2005, p.39).

3.4 Basin scale geomorphological contexts

3.4.1 Introduction

At catchment scales, long profile gradients and drainage network properties influence channel hydraulics (e.g. Barker et al., 2009) and bedform and habitat creation at smaller scales. Catchment surface erosion, basin-channel connectivity and sediment/organics delivery are also crucial to nutrient transport and fluvial suspended sediment dynamics, ingress and habitat health. It is important to recognise the key continuous or discontinuous downstream changes in flow and water recruitment, channel geometry, channel sediments, habitat 'disturbance', erosion, sediment transport and deposition processes (e.g. Lawler, 1992, 2008), because this will impact on hyporheic zone processes. Some catchment scale changes and downstream change models are therefore summarised here.

Geomorphological and hydrological downstream change models summarise many of these effects and processes. These have also proved useful in freshwater ecology. For example, it is well established that there can be systematic downstream associations at catchment scales between channel form and process and habitats and ecosystem function, such as embodied in the river continuum concept (Vannote et al., 1980) or in specific biological effects, such as fish assemblages.

3.4.2 UK hydrogeomorphological context

Of key importance to hyporheic zone operation is basic precipitation input to the hydrological system. Storm rainfall events, in particular, help to drive inputs of water, sediments, solutes, nutrients, seeds, organic materials and contaminants from catchment surfaces and soils to river channels and to hyporheic zones, and drive flow events which (a) erode the channel banks and bed to deliver more sediment downstream, and (b) set up the conditions for surface penetration into the hyporheic zone.

In the UK, there is clear tendency for rivers to become increasingly flashy, dynamic and unstable from SE to NW. This will affect HEFs and channel stability and could therefore be a key input to any river restoration design. This strong environmental gradient largely relates to an increasing average annual precipitation; increasing rainfall seasonality; a greater tendency for flood-producing storms to occur in winter (rather than summer), when hydrological sensitive areas of catchments are likely to be primed; higher absolute river discharges and specific runoff (discharge per unit catchment area); steeper valley-sides and stream longitudinal profiles; and a well-developed cover of loose, erodible glacial materials, linked to Devensian glacial and periglacial conditions (Figure 3.2).

Also, in general, surface water in upland areas is characterised by high DO dissolved oxygen (DO) values at, or near to saturation, low alkalinity and electrical conductivity indicative of short residence times, and a highly variable thermal regime. Groundwater is typically characterised by high alkalinities indicative of weathering processes and longer residence times (Soulsby et al., 2005), higher electrical conductivity, and a relatively stable thermal regime.

In typical lowland England chalk streams, connections between valley fills and GW-SW interchange are readily apparent. For example, Grapes et al. (2006, p. 324) argued for the Lambourn that 'as the floodplain widens and the alluvial gravel aquifer increases in size, the gravel aquifer accounts for a substantial down-valley component of groundwater flow with a diffuse vertical water flux. In the lower catchment, the exchange of flows between the gravel aquifer and the river enables some attenuation of floodplain water-table variability, providing a stable hydrological regime for valley-bottom wetlands' (Figure 3.4). The results of Gooddy et al (2006, p.51), based on CFC and SF₆ tracers, tend to confirm this. They also suggest that, adjacent to the Lambourn, GW-SW interaction appears to occur to depths greater than 10 m. In such systems, where most water in the stream channel is groundwater derived basic water chemistry is likely to be of limited value in determining hyporheic dynamics and a more complicated suite of analytes or other indicators of water source, such as temperature, may be more useful tracers.

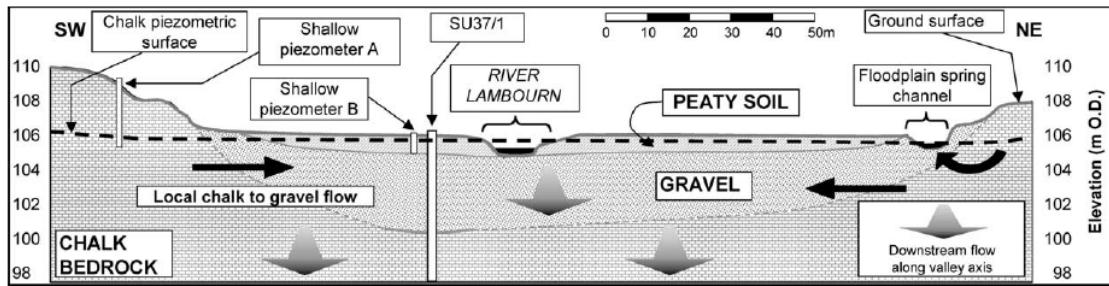

Figure 3.4 Schematic cross-section across the Lambourn valley at West Shefford showing the location of measuring points and the inferred relationship of valley floor sedimentology to local and regional groundwater flows (Grapes et al., 2006).

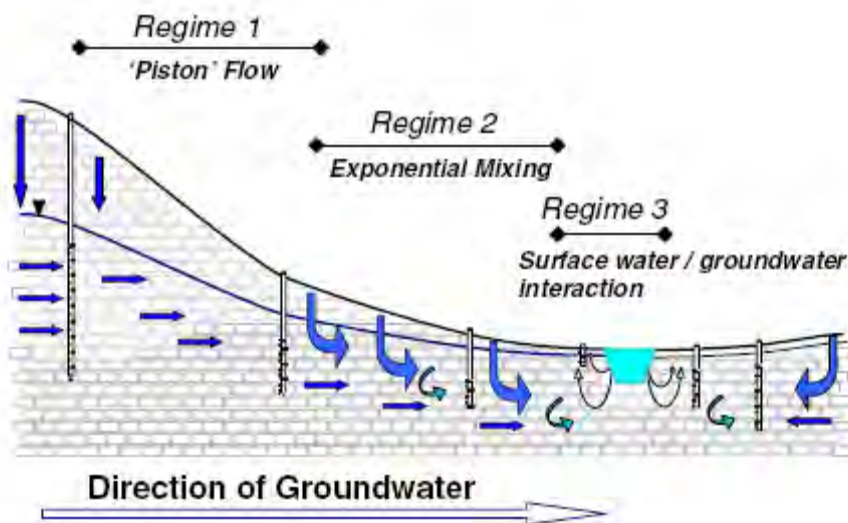

Figure 3.5 Conceptual model of three groundwater flow regimes (1-3) moving down gradient towards the R. Lambourn, southern England (Goody et al., 2006).

Basin and stream scale exchange processes are, to a large degree, controlled by variations in subsurface lithology. For instance, as streams move from zones of bedrock constriction into zones of permeable alluvial deposits, deep penetration of surface water into the alluvium may occur (Figure 3.6). At the catchment scale, exchange can be controlled by changes in valley width, depth to bedrock and aquifer properties (Stanford and Ward, 1993). Upwelling back to the channel will occur as the channel re-enters a zone of constriction (Stanford and Ward, 1988). Subsurface flow of this nature will penetrate deep into the substratum, and result in extended flow paths and long residence times of water within the subsurface environment. Malcolm et al (2008) show how reaches located immediately upstream of major transverse valley moraine features comprised of poorly sorted material of low permeability, such as those found in western and northern Britain, are associated with strong groundwater upwelling. These valley constrictions reduce channel gradients upstream and promote gravel accumulation in the valley floor. They also channel down-valley groundwater movement towards the stream and, consequently, lower the local quality of hyporheic water.

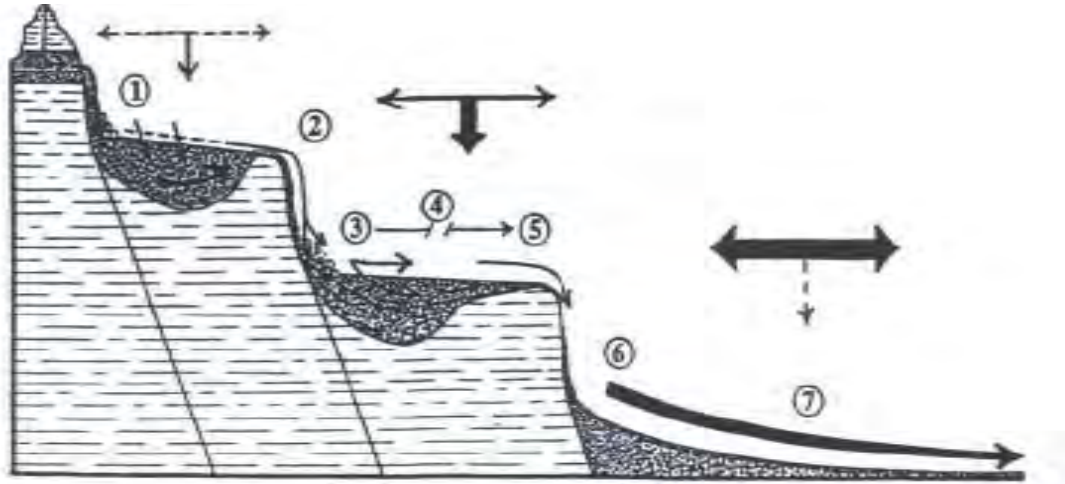

Figure 3.6 Zones of bedrock constriction and permeable alluvial deposits, showing deep penetration of surface water into the alluvium (Stanford and Ward, 1993).

3.4.3 Catchment-scale fluvial system models

The Downstream Hydraulic Geometry model advanced by Leopold and Maddock (1953) came to dominate fluvial geomorphology for the following 25 years, and led directly to the River Continuum Concept (RCC) in freshwater ecology of Vannote et al (1980). Leopold and Maddock (1953) quantified at basin scales systematic changes in river channel form and flow properties in a downstream direction. Their simple, generalised, but classic, plots and log-log regressions which defined power-law expressions for a range of US rivers, established relationships which linked downstream increases in discharge to changes in channel width, depth and mean velocity, but also in roughness and width-depth ratio. Examples of the classic downstream Hydraulic Geometry relationships are reproduced here in Figure 3.7.

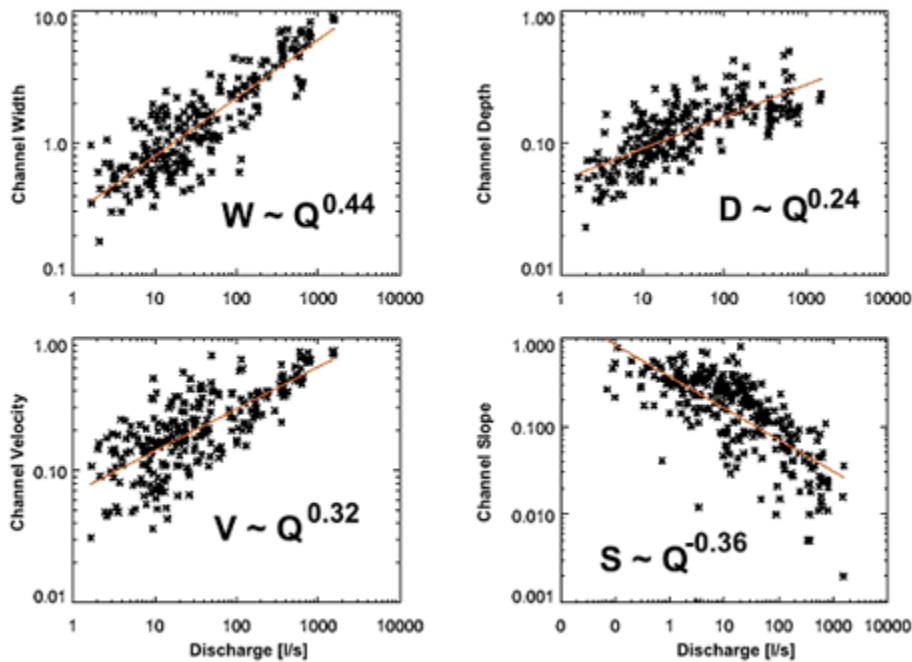

Figure 3.7 Example hydraulic geometry relations for a small stream (Ashley River basin, New Zealand) defining approximate power-law downstream changes in channel width, mean depth, mean velocity and slope in relation to increasing discharge, based on an approach pioneered by Leopold and Maddock (1953). Source: McKerchar et. al., 1998).

These US findings have largely been reproduced elsewhere, including for UK river systems (e.g. Hey and Thorne, 1986): however, hydraulic geometry implies generalised patterns and gradual changes, and these may mask key longitudinal *discontinuities*, for example at stream confluences or geological boundaries (Figures 3.8 and 3.9). Nevertheless gradual or abrupt downstream changes should have hyporheic zone implications, though this has been under-researched. For example, in headwater rivers where banks occupy a much greater proportion of the channel wetted perimeter than in much wider lowland rivers, potential lateral HEF potential through the banks, rather than beds, may be proportionately greater, especially at high flows.

A key finding, contradicting a long-held, but rarely-tested, belief was that for most rivers, for most of the time, mean velocity modestly *increased*, not decreased, in a downstream direction (Figure 3.7). This increase was thought to be a result of a downstream decline in channel roughness and increase in hydraulic efficiency (often indexed respectively by bed surface particle size and channel hydraulic radius), which were more than enough to offset a decreasing slope (Figure 3.7), much as application of a Manning-Strickler type equation might suggest.

Downstream Hydraulic Geometry concepts also had process-inference capabilities. For example, channel cross-section area was shown to increase systematically downstream, implying a downstream adjustment to an increasing discharge imposed by the basin. Furthermore, width generally increases downstream at a faster rate than depth: for example note the width exponent of ~ 0.44 , relative to depth exponent of ~ 0.24 , in Figure 3.7. This therefore implies that banks are more readily erodible than river beds and streams preferentially widen to accommodate the ever-increasing discharge in a downstream direction. Such simple concepts therefore form a key link between *catchment* attributes (which drive discharge generation), and *fluvial* forms and processes, through a set of complex feedback effects. There are probably further

implications for hyporheic zone operation and management (especially the need for a catchment approach), and recently explored ideas are discussed in the reach- and site-scale sections below.

3.4.4 CASSP model: high-resolution flow and stream power variations downstream

Stream power is increasingly seen as simple yet powerful channel hydraulics variable, and a useful measure of available energy to drive bed disturbance, bedload transport and river bank erosion rates, so is important to hyporheic zone operation. For example, gross stream power, Ω , in W m^{-1} , is derived as

$$\Omega = \rho g Q S \quad (1)$$

where ρ is density of water (1000 kg m^{-3}), g is gravitational acceleration (9.81 m s^{-2}), Q is discharge ($\text{m}^3 \text{ s}^{-1}$) and S is channel longitudinal slope (m m^{-1}) (Lawler, 1992; Barker et al., 2009). Lawler's (1992) model, now known as the CASSP (CAatchment Scale Stream Power) model, suggested that, contrary to earlier assumptions, downstream stream power trends were unlikely to be simple monotonic increases or decreases, but to be highly non-linear. He argued that as fluid density (1000 kg m^{-3}) and gravitational acceleration (9.81 m s^{-2}) in Equation (1) were constant in a downstream direction, models of downstream trends in gross stream power needed to focus only on changes in discharge and energy slope (approximated to channel or floodplain slope). Simple numerical simulations showed that stream power should peak in some intermediate location in the catchment where an optimum combination of discharge and slope existed (Figure 3.8). In the headwaters, where discharges were low, stream power should also be low, despite steep slopes. In lowland reaches power should also be low, given low slopes, despite high discharges. The CASSP model suggests that high-energy intermediate locations in catchments should be zones where bed gravel disturbance potential should be high and limited fine sediment accumulations exist; this should maximise HEF potential, though this remains to be tested in the field.

The Lawler (1992) model (Figure 3.8) was subsequently successfully tested by a number of workers in UK, USA and Australia who confirmed peaks in stream power in intermediate basin locations (e.g. Abernethy and Rutherford 1998).

The most recent derivation is given in Barker et al. (2009) where, in addition, downstream trends in elevation, slope, median annual flood discharge (QMED; 2-year return period flow) and gross stream power are presented for a number of UK rivers generated by the new CAFES (Combined Automated, Flood, Elevation and Stream power) methodology. This approach is useful for estimating stream power trends at 60 m resolution along entire river mainstems (e.g. Figure 3.9). These high-resolution data confirm that downstream trends are far from the simple generalised patterns first envisaged in the classic downstream hydraulic geometry concept (Leopold and Maddock, 1953). They also confirm a high degree of stream power non-linearity as predicted by CASSP (Lawler, 1992), but also suggest that multiple peaks and high reach-scale variability may be important (Barker et al., 2009). Figure 3.9 shows clear links between elevation longitudinal profile, derived channel slope, median annual flood and gross stream power. Figure 3.9 also demonstrates that UK river longitudinal profiles can depart significantly from the classic exponential profiles often depicted schematically, and these profiles will drive complex water surface slope and head variations and thus hyporheic exchange flows.

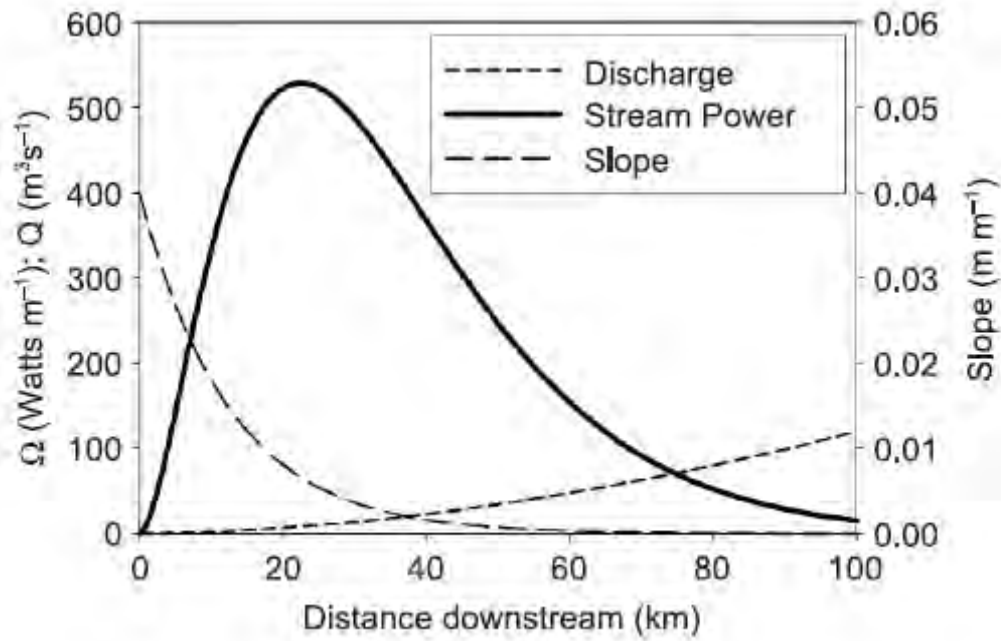

Figure 3.8 Conceptual generalized stream power model proposed by Lawler (1992), now known as the CASSP (CAtchment-Scale Stream Power) model. This schematic example simulates downstream trends in gross stream power using CASSP, with coefficients of $k = 0.03$, $m = 1.8$, $S_0 = 0.04$ and $r = 0.08$, and is presented in Barker et al. (2009).

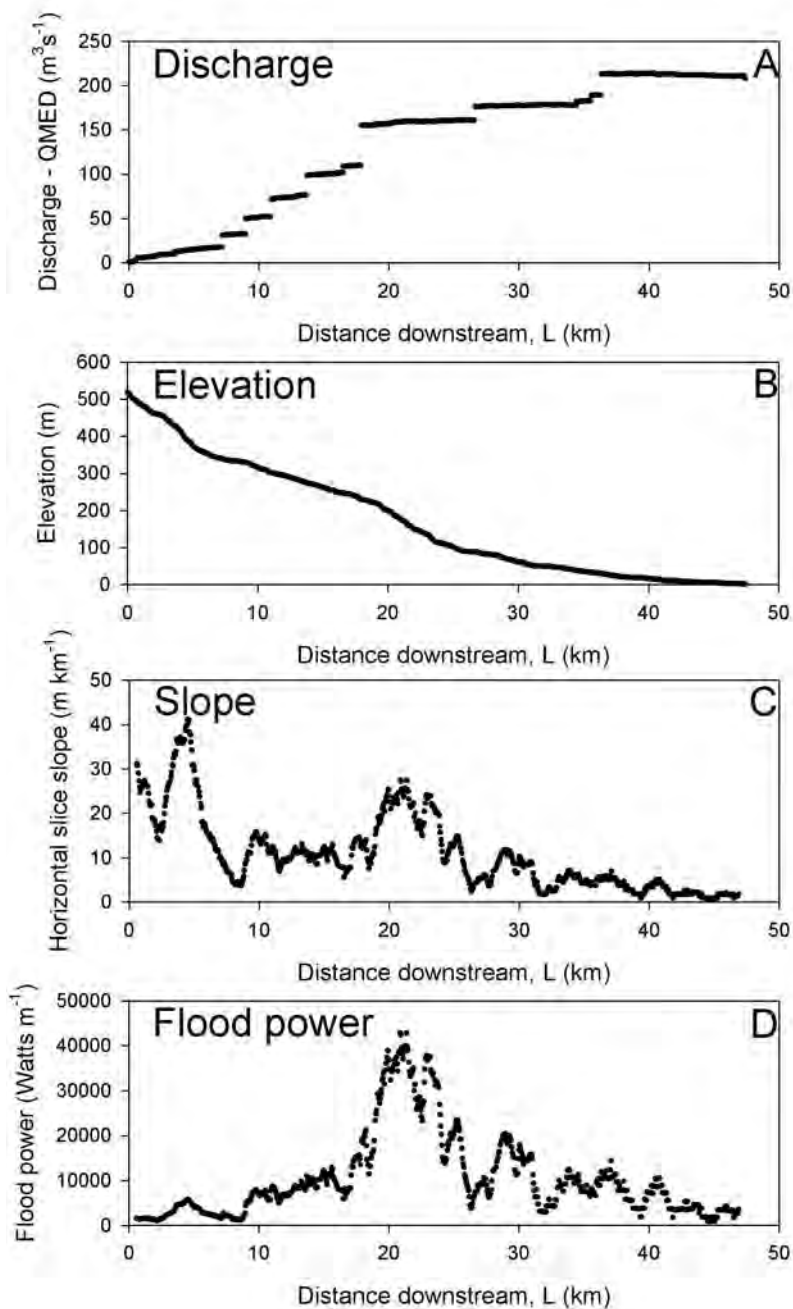

Figure 3.9 Downstream changes in discharge (QMED: the median annual flood, i.e. 2-year return period flow), elevation, channel (floodplain) slope and gross stream power for the River Dart, Devon (after Barker et al., 2009). This new CAFES (Combined Automated, Flood, Elevation and Stream power) methodology has now been applied to 34 rivers in the UK, to produce downstream change patterns as for the R. Dart above. For eight of the 34 rivers, additional downstream trends in specific stream power (in W m^{-2}) have been estimated.

Analysis of trends in *specific* stream power ω ($= \Omega/w$), in W m^{-2} , where w is channel width, which is an even stronger control of sediment transport (see below), also suggests peaks in intermediate basin locations (Lawler, 1992).

The longitudinal flow recruitment profiles (e.g. Figure 3.9) will themselves reflect GW/SW interaction at catchment scales (e.g. Grapes et al, 2006; Goody et al., 2006'

Figures 3.4-3.5) and could serve as useful inputs to hyporheic zone models, which require discharge and stage inputs to drive HEFs (see Chapter 4). Note in Figure 3.9 the expected rapid flow increases at tributary junctions, but also the gently ramped flows in the inter-tributary reaches reflecting inputs from throughflow and groundwater systems.

When high-resolution downstream trends in stream power (e.g. Figure 3.9), are combined with data on median grain size or particle size distributions of bed gravels, it should be possible for fluvial scientists and catchment managers to identify those parts of the stream system likely to undergo regular bed disturbance, gravel bedload transport and remobilisation of fine sediment and eventually, to predict the fluxes involved. Such disturbances may change bed gravel hydraulic conductivity during and after competent flow events, and therefore hyporheic exchange flows. Such analyses will be further enhanced with spatial data on *specific* stream power, ω ($= \Omega/w$), in $W m^{-2}$, where w is channel width: ω is even more strongly related to sediment transport and accumulation (see below), and similar trend analysis here also suggests peaks in intermediate basin locations (Lawler, 1992).

3.5 Reach scales

3.5.1 Introduction

Geomorphologic complexity at nested scales is the fundamental driver of hyporheic flow (Cardenas, 2008). Despite the recognition of the importance of channel geomorphology in hyporheic zone operation, Anderson et al. (2005, p.2932) argue that 'there has been little attempt to use systematic patterns in stream geomorphology to predict how patterns of hyporheic exchange flow will change between stream reaches in headwater and larger streams.'

It is important, however, to appreciate the geomorphological context, controls and impact on hyporheic zone flows of such reach-scale features, and Anderson et al., (2005, p.2931) have called for a 'better characterisation of the important physical and hydrometric properties of stream-catchment systems that determine the characteristics of transport within a hyporheic zone and that can be routinely measured or mapped along greater distances of streams' (see Bencala, 2000).

At the reach-scale, exchange of surface water with the riverbed is driven primarily by topographic features and changes in bed permeability (for example Harvey and Bencala, 1993). Streambed topography induces surface-subsurface exchange by creating pressure differentials above the bed. Down-welling is associated with local areas of high to low pressure change, for instance the interface between a pool and a riffle, and up-welling is associated with local areas of low to high pressure gradients, for instance at the interface between a riffle and pool (Figure 3.10). Reach scale changes in substrate permeability also create areas of up-welling and down-welling, with down-welling occurring in areas of decreasing permeability, and up-welling in areas of increasing permeability. In zones of well defined bed topography and heterogenous substrate composition, reach-scale exchange processes will result in mosaics of subsurface flow paths of variable flow path length and depth, although, typically, flow paths are shallower and shorter than those operating at the basin and stream scale. Flow path lengths are closely associated with the size of geomorphic features and are typically measured in tens of metres.

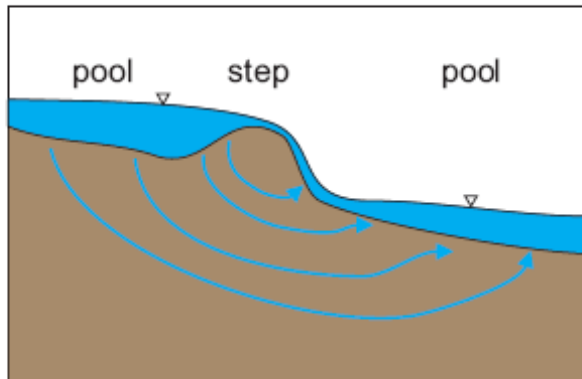

Figure 3.10 Hyporheic flow due to changes in free water surface elevation across a step-pool sequence.

3.5.2 Reach-scale geomorphological influences

Hyporheic exchange, excluding trapping and release of interstitial water due to sediment scour and deposition, is primarily driven by variability in pressure or head gradients along the river-sediment or river-aquifer interface which develop due to fluvial geomorphologic features. Geomorphologic features lead to variable pressure gradients by three mechanisms: 1) by inducing vertical hydrostatic head gradients, 2) by inducing horizontal hydrostatic head gradients, and 3) by inducing dynamic head gradients due to current-topography or current-obstacle interactions. See Chapter 4.

In steep mountain streams with shallow flows, pronounced changes in riverbed elevation lead to similar changes in the river's free water surface configuration. The best example of this is across a pool-step-pool or pool-riffle-pool sequence. Hydrostatic head, approximately equal to the elevation of the free water surface, is higher above the step/riffle than below the step/riffle leading to a vertical pressure gradient that drives flow across the step/ riffle (Figure 3.10) (Anderson et al., 2005; Harvey and Bengala, 1993). Recent studies suggest that isolated and abrupt changes in head can have far-field effects resulting in hyporheic zones that extend beyond the source of the head change.

3.5.3 Pool-riffle sequences

Gravel bars are thus key features of river channels, including for hyporheic zone operation. Riffles are especially important, especially for hyporheic zone flows and, in particular, zones of upwelling and downwelling (Figure 3.11). Indeed, Gooseff et al. (2006) found that 'channel unit spacing, size, and sequence (were) all important in determining hyporheic exchange patterns of upwelling and downwelling (and) ... similar trends emerged relating the average geomorphic wavelength to the average hyporheic wavelength in both surveyed and idealised reaches'.

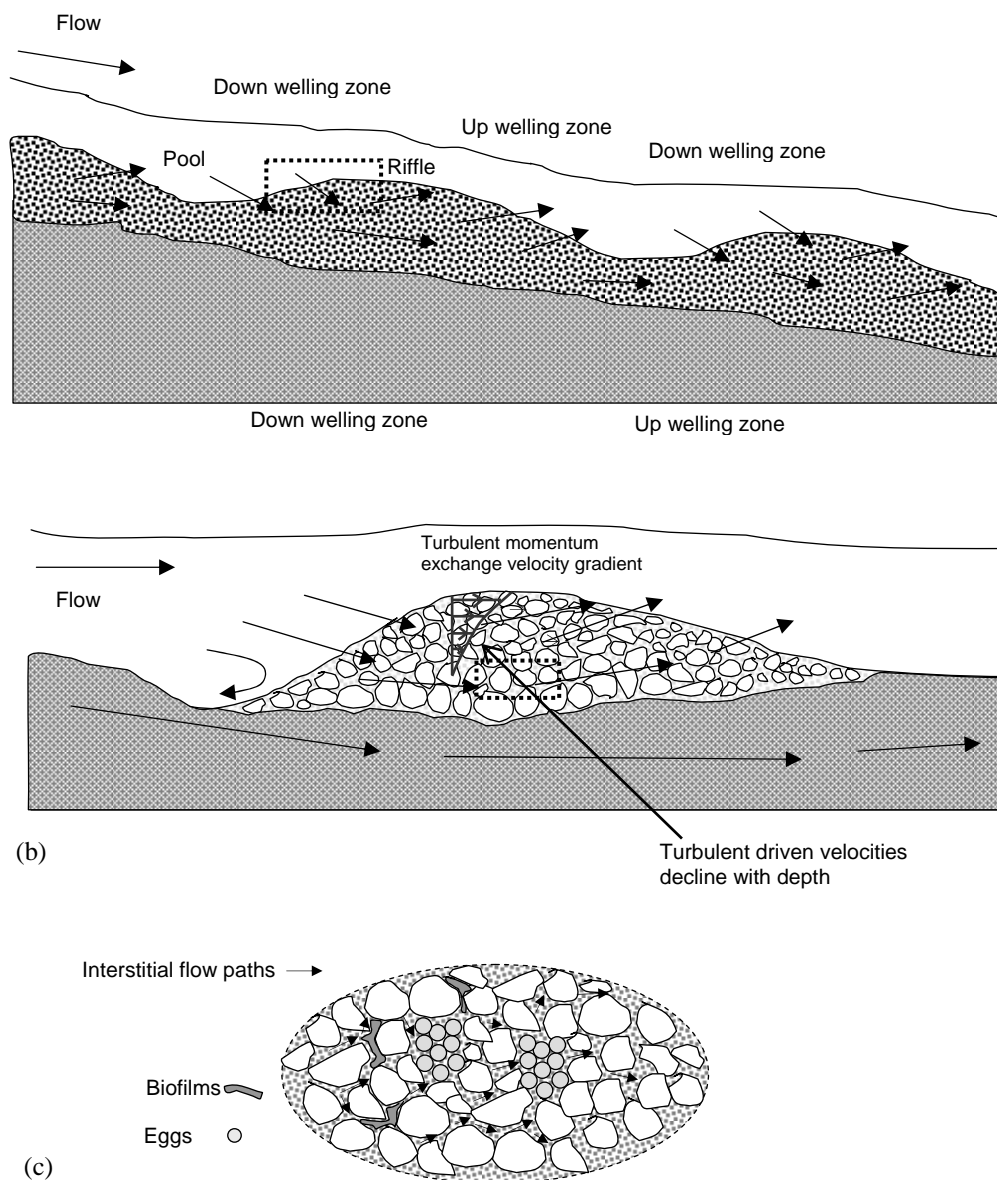

Figure 3.11 Subsurface flows; (a) Reach-scale surface subsurface exchange flows. (b) Micro-scale exchange flows (redd). (c) Interstitial flow paths within the gravel bed (after Grieg et al., 2007).

However, few detailed datasets exist on riffle-pool unit morphology (Carling and Orr, 2000). Hey and Thorne (1986) found that for straight, sinuous and meandering rivers in Britain, average riffle spacing, z (m), was approximately $z = 6.31w$, where w is bankfull width (m), the range being 4-10 w . However, a more recent analysis by Newson et al (2002) showed that the range was 3-21 w , and that channel slope also influenced pool-riffle sequences thus:

$$z = 7.36w^{0.896} S^{-0.03} \quad (2)$$

Furthermore, as channel gradient reduces, bedforms flatten and become more asymmetric as riffle stoss sides and the proximal slope of pools lengthen at the expense of riffle lee sides and pool distal slopes (Carling and Orr, 2000).

3.5.4 Channel planform impacts

Channel planform can also drive flow structures and velocity distributions important for sediment transport continuity and redistribution of bed sediment. Irregularity of river bank and planform morphology leads to horizontal head gradients. When convexities or concavities are present along the bank, such as a bar protruding horizontally into the channel, hydrostatic head is higher in the upstream portions of the bank and lower in the downstream portion leading to variable pressure gradient across the feature (Figure 3.12). Therefore, any irregularity in an otherwise straight river, including subtle changes, induces hyporheic exchange. This process has long been recognised as a driver of surface water-ground water connection at channel-floodplain to alluvial valley scales. Hyporheic exchange along banks is in fact a smaller scale and more localised version of this process and may be driven even by small concave-convex features along banks such as alternating unit bars (Figure 3.12a) or even by mid-channel transverse bars (Figure 3.12b). Sinuosity-driven hyporheic flow across point bars (Figure 3.12c) was recently studied in detail (e.g. Cardenas, 2009). Numerical flow models suggest that hyporheic flux and residence time is strongly tied to river planform morphology; more sinuous channels result in a broader distribution of fluxes and residence time.

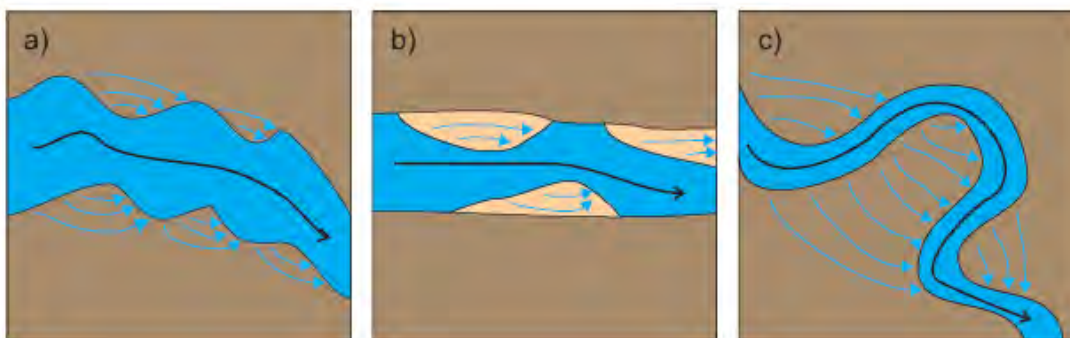

Figure 3.12 Hyporheic flow due to lateral changes in channel and bank morphology. a) hyporheic flow due to subtle changes in bank morphology even without a mean change in channel sinuosity, b) hyporheic flow along unit bars on the sides of the channels, c) hyporheic flow due to channel sinuosity.

3.6 Site and bedform scales

3.6.1 Introduction

At site scales, such as the level of an individual riffle or pool, local bed form configuration and sediment characteristics (e.g. channel substrate architecture, particle size and shape distribution, pore geometric properties and connectivity, armour development and surface roughness) impact strongly on hyporheic water and nutrient exchanges. Local channel geometry (e.g. wetted perimeter and width/depth ratio, including shading potential) also influences the lateral and vertical extent of the hyporheic zone, and its thermal cycling behaviour.

At this scale, topographic features generally result in shallower penetration of surface water and shorter flow paths than reach-scale driven exchange (e.g. Malard & Hervant, 1999). Obstacles in the streambed, such as log jams and boulders, cause pressure differentials that induce surface-subsurface exchange with the hyporheic zone. Similarly, freshly created salmon redds contain gravels of enhanced permeability and

have a distinct morphology that induces downwelling of surface water into the redd (Figure 3.11b) (e.g. Carling et al., 1999).

The influence of surface roughness on the coupling of surface-subsurface flow has been investigated in a number of flume studies (e.g. Packman and Bencala, 2000). Tracer experiments investigating flow through a flat bed under varying discharges, have shown that intragravel pore water velocities increase towards the bed surface; suggesting a coupling of surface and subsurface flow. This surface-subsurface coupling has been attributed to turbulence induced by roughness at the bed surface. This turbulence promotes a slip velocity and an exchange of momentum with subsurface water (Figure 3.11b) (e.g. Packman and Bencala, 2000). Finally, the infiltration of fines and growth of biofilms influences the porosity of the gravel matrix (Figure 3.11c).

3.6.2 Bedform influences

Fluid motion near solid boundaries with irregular surfaces leads to changes in dynamic head along their boundary (e.g. Figure 3.13). The simplest case for this is Bernoulli's Law which states that fluid deceleration or acceleration along a continuous path or streamline leads to corresponding changes in velocity head. However, turbulent flow dynamics in rivers is more complicated. Dynamic head gradients develop due to form drag and flow recirculation induced by obstacles along the river bed.

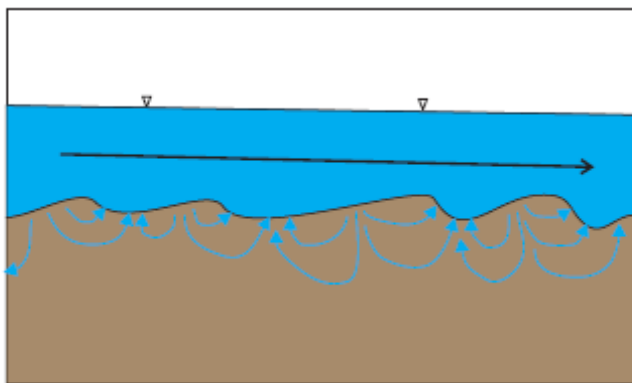

Figure 3.13 Hyporheic flow due to gradients in dynamic head formed when water flow encounters an irregular boundary (bedform).

More recently, it has been directly shown that recirculation in the lee side of bedforms plays a key role in generating the pressure gradient along the river-sediment interface (Cardenas and Wilson, 2007). The eddy separation point corresponds to a pressure minimum while the eddy attachment point, which is a stagnation point, corresponds to pressure maximum. The pressure gradient along the river-sediment interface is determined by the location and magnitude of these two points. This mechanism is active even in the absence of variations in the elevation of the free water surface and is more likely to dominate in sandy streams at low-Froude Number flows.

3.6.3 Variability in hydraulic properties of riverbed sediment

Variability in hydraulic properties of riverbed sediment can also induce hyporheic flow even in the absence of pressure gradients along the river-sediment interface. In an ideal scenario where the permeability of sediment is uniform and that it is of infinite horizontal extent and where the free water surface and sediment-water interface is sufficiently smooth (uniform head gradient), interstitial flow in the sediment would be

mostly parallel to the sediment-water interface (Figure 3.14a). However, these sub-parallel flow paths could be deflected away from, or bend towards, the river-sediment interface when flowing interstitial water encounters changes in permeability (Figures 3.14b and c), leading to hyporheic zones. These changes in permeability may be due to juxtaposition of gravel, sand, silt, and clay in the alluvial material (Figure 3.14b) or due to changes in topography of underlying bedrock or finer-grained sediment (Figure 3.14c) (Hill et al., 1998).

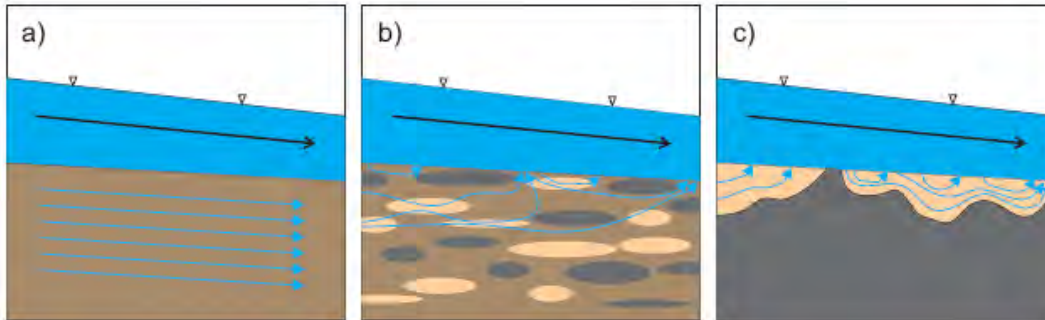

Figure 3.14 Hyporheic flow due variability of hydraulic properties of the alluvial material. a) case with no variability leading to no hyporheic flow, b) heterogeneous streambed, c) variability in bedrock or 'aquitar' topography.

3.6.4 Multiple influences

The mechanisms discussed above are not mutually exclusive, but one mechanism may be favoured depending on the geomorphologic and hydraulic conditions in a specific river-sediment system. For example, hyporheic exchange flux may be large in step-pool sequences typical of steep upland/mountain channels since these tend to occur in coarse-bedded channels which are more permeable, and the hydrostatic head gradients tend to be much larger than dynamic head gradients generated by current-topography interactions. On the other hand, hyporheic flow paths along point bars of meandering low-gradient rivers may be very long and can have a broad distribution of residence times (e.g. Cardenas, 2008). Depending on the purpose for analysing hyporheic processes, one mechanism may be emphasised based on the time and spatial scale of the processes of interest. The potential dominance of one mechanism is a promising aspect for predicting the extent and magnitude of hyporheic exchange.

For example, the geomorphologic community has long sought to develop models that predict which feature would dominate along different parts of a river and a river network. There are now conceptual and quantitative models that predict which types of bedforms may dominate in a sandy stream whilst considering eddy dynamics; at the very least, typical ranges for bedform shapes for a given characteristic grain diameter and hydraulic conditions are reasonably predictable. Step-pool spacing and organization has been studied extensively and is predictable to certain extent (e.g. Church and Zimmermann, 2007). Typical ranges for channel sinuosity and their relation to mean valley gradient and mechanical properties of bank material have been developed and tested. A few studies have now been able to reasonably classify expected geomorphologic characteristics of channel segments depending on location in the river network and catchment and its associated potential for hyporheic exchange using slope and drainage area as predictive metrics (Buffington et al., 2004). Although most past studies have been in one or two dimensions, geomorphologic and hydraulic studies are now venturing into three-dimensional processes (e.g. Worman et al., 2007). A more extensive integration of vast amount of knowledge from geomorphology and using these as inputs or templates for rigorous hydraulic studies would lead to robust

models that would allow for prediction of key hyporheic exchange metrics such as aerial extent, fluxes, and residence times.

3.7 The role of fine sediment

3.7.1 Essential concepts

Sediments and any associated contaminants deposited on river beds may be derived from within the river channel itself (for example through river bank erosion) or from the catchment (such as erosion of cultivated fields or gullies) (Table 3.5). From section 3.6.3, it is clear that the presence of fine sediment is a key constraint on hydraulic conductivity and therefore hyporheic zone operation. This section, therefore, discusses the processes of sediment ingress into river beds, and gives data on typical amounts, particle size distribution and character of fine sediment present, especially in UK river systems.

The process by which fine sediment moves into gravel beds termed *sediment infiltration*, or *colmatation* in the environmental engineering literature, and the summation of this process over time that is *accumulation*. An additional term often used in the context of fine sediment impacts on salmonids is *sedimentation*. This refers to the development of a layer of fine sediment over the bed surface. The processes of fine sediment infiltration into gravel beds have been researched for more than forty years (e.g. Greig et al., 2005a). Observations suggest that the dominant processes controlling the character and distribution of fine matrices in gravels are best considered in two groups: 1) those acting in the water column which deliver fine sediment to pores in the upper surface of the deposit and 2) those acting within the sediment to redistribute material delivered to surface pore spaces. However, these complex processes are not mutually exclusive and operate either simultaneously or sequentially in most gravel river beds.

3.7.2 Processes of fine sediment infiltration from the water column

In the water column, fine sediment movements are driven by two main processes: (i) gravity driven infiltration that includes simple Stokes-type settling; and (ii) advection of fine material into the bed by fluid turbulence. All else being equal, coarser and heavier particles will drop out of suspension first, giving a natural spatial and temporal size segregation in the resulting deposits. Particle shape is also a key factor, as the less spherical a particle is, the slower it will settle. In addition, silts and clays often form *flocs*, aggregated groups of particles with varying and low densities that settle in an unpredictable manner.

Delivery of fine sediment to a gravel bed is actually a product of both gravitational settling and turbulence (e.g. Carling, 1984). Gravity was found to dominate coarse particle settling (median grain diameter, $D_{50} > 350 \mu\text{m}$) whilst turbulence influenced the settling of finer particles ($D_{50} < 350 \mu\text{m}$). Once delivered to the surface of the bed, the onward penetration into subsurface layers is influenced by gravity and fluid movement. Gravity settling is often seen as the most important factor controlling the infiltration of larger (<1mm) particles into a permeable bed. However, experimental results have shown that when settling is dominant during low flows, fine sand size material often remains close to the surface of the bed and forms a surface 'seal', suggesting that other factors control the mobilisation of this material and its movement into sub-surface pores (Figure 3.15a). Amongst these factors are the size and shape of the particles and pores, bed disturbance during entrainment events and particle filtration as fluids move through the bed. 'Armoured' beds (those where the smaller gravel particles have

been preferentially entrained to leave behind a coarse surface layer) result in a distinct contrast between surface and sub-surface pore sizes. In this type of bed, matrix particles that can easily penetrate the surface layers can become trapped at the top of the smaller sub-surface bed material (Figure 3.15b).

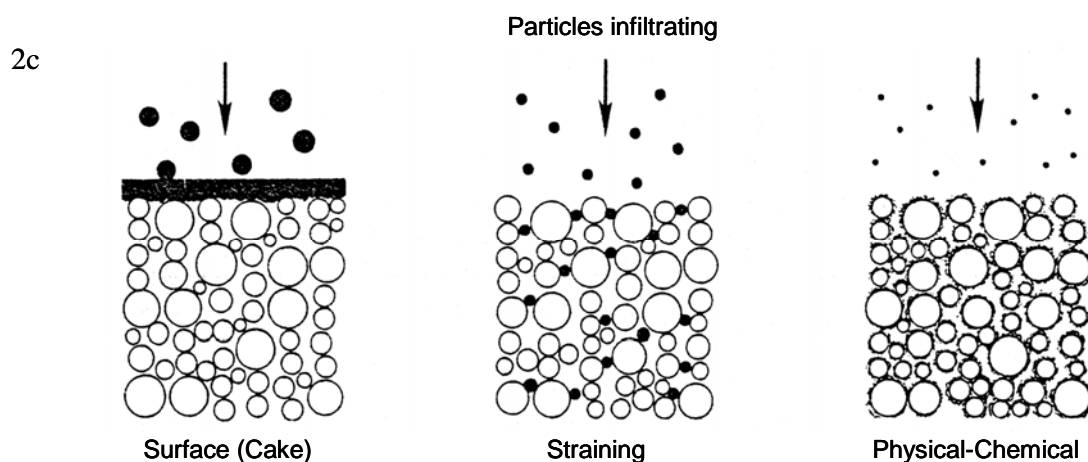
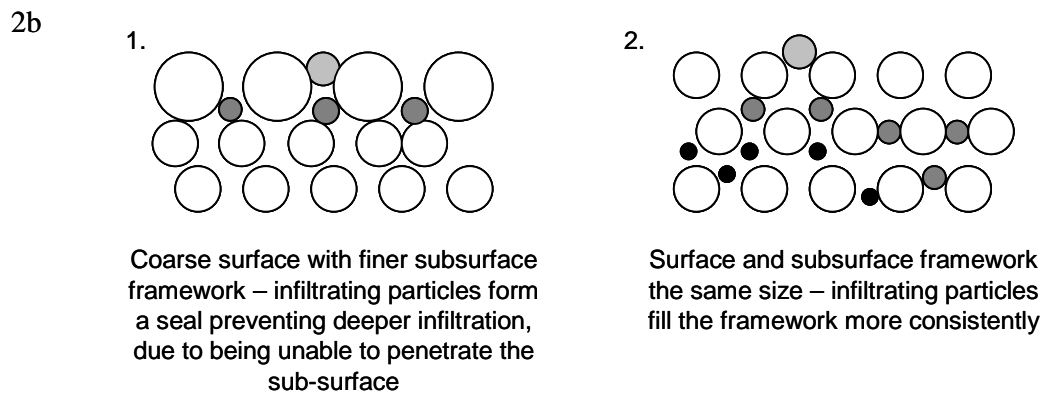
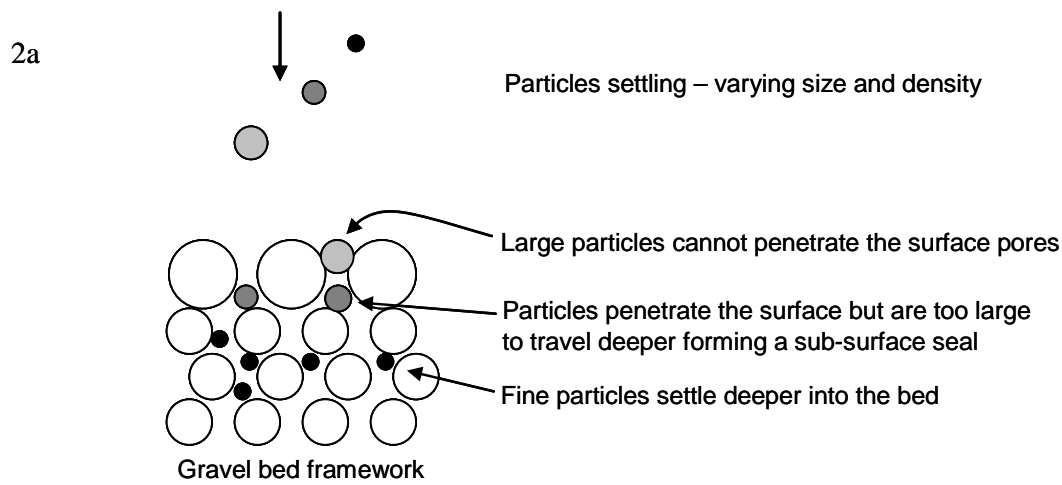

Figure 3.15 Sediment infiltration into river beds: a: Passive infiltration into a gravel bed; b: Relationship between gravel bed type and infiltrating sediment; c: Three filtration mechanisms for sediment infiltration into porous beds. Note the particle size dependence and difference in deposit morphology (Modified from McDowell-Boyer et al. 1986 and Sear et al. 2008).

When flows increase sufficiently to disturb the framework of the bed, such as when critical stream powers or shear stresses have been exceeded, the pore spaces dilate and fine sediment is able to settle deeper into the bed. Entrainment of surface particles and temporary imbalances in bed-material transport cause scour and fill of the bed. Scour allows fine sediment to penetrate deeper into the bed. Fine sediment can infiltrate deeper into a coarser framework by associated fluid intrusion. Fluids penetrating the bed can transport fine sediment into the framework either by suspension or by direct force.

3.7.3 Organic matter accumulation in spawning gravels

In many streams, fine sediments are composed in part by organic material (Sear 1993). This is important because the process of oxidation of organic matter creates a Sediment Oxygen Demand (SOD) within the spawning gravels that directly competes with the incubating eggs (Greig et al., 2005a). Organic material is derived from either in-stream sources (autochthonous), for example, macrophyte vegetation, or from external sources (allochthonous), for example, leaf litter or runoff from agricultural practices. Generally, organic sediment inputs are positively correlated with seasonal vegetation growth. For example, in groundwater-dominated chalk rivers, there is a general increase in percentage organic component of deposited sediments over the summer when instream productivity is highest. However, organic inputs are also derived from specific activities within a catchment such as logging practices.

3.7.4 Modelling fine sediment infiltration and accumulation

Empirical models have two forms: prediction of fine sediment accumulation in redd gravels based on field measurements of the infiltration rate and extrapolation over time (e.g. Soulsby et al., 2001), and prediction based on a series of empirical relationships that broadly represent the processes of sediment transport, infiltration and egg survival. However, analytical models, such as the Sediment Intrusion and Dissolved Oxygen (SIDO) model, attempt to predict near-bed sediment concentration and the infiltration process. SIDO models the processes of sediment transport and infiltration into a static salmonid redd composed of multiple grain sizes and the supply rate of oxygen transported through the gravel bed, egg consumption and temperature dependence. All elements are coupled, enabling the prediction of dissolved oxygen and egg survival within redds.

3.7.5 Fine sediment and intragravel oxygen fluxes

Fine sediment accumulation has been directly linked to the decline in gravel oxygen supply to incubating salmonids (Greig et al., 2005a). The processes responsible include direct physical effects on the egg through blocking of the micropores (Greig et al., 2005b), or indirectly via the occlusion of the voids between the framework gravels. There is a negative correlation between the quantity of fine sediment within spawning gravels and their permeability. However, permeability is also influenced by the particle size of the infiltrated material, the presence of organic flocs that can coalesce, or the development of biofilms. Greig et al (2005a) and Malcolm et al. (2008) demonstrate a strong correlation between fine sediment accumulation and intragravel flow velocity at individual UK field sites. Reduced velocities can reduce dissolved oxygen supplies to, and toxin removal from, redds (Figure 3.16). Zimmerman & Lapointe (2005) detail the *intra-event* relationship between fine sediment supply (measured as suspended sediment concentration) and a drop in the intra-gravel flow velocity.

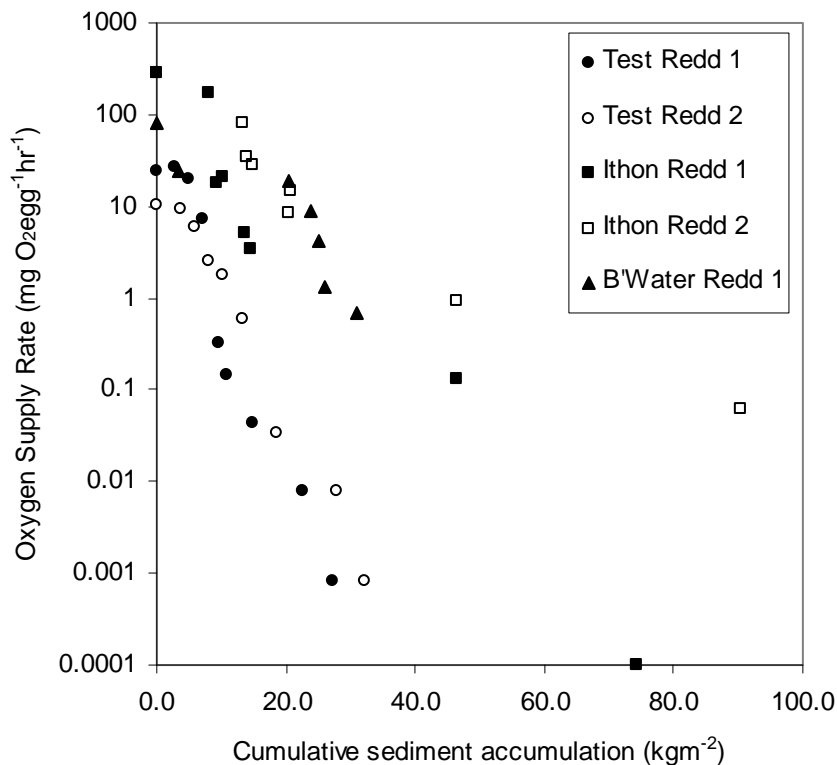

Figure 3.16 Strong correlation between fine sediment accumulation and oxygen supply rate (Sear et al., 2008).

3.7.6 Sediment quantity and properties

The national extent of siltation in the UK is poorly understood, given limited monitoring, and very different measurement methods (e.g. freeze coring, infiltration baskets, sediment traps, and shovel sampling). Naden et al. (2003) review the techniques available for monitoring particulates in water columns and substrates, and give data on siltation extent for UK rivers: more recent data for UK rivers are given in, for example, Collins and Walling (2007a; 2007b).

3.7.7 Siltation at the bed surface and subsurface

Milan et al. (2000) collated data from freeze coring UK river bed substrates for three stream types: I -upland streams characterised by impermeable metamorphic and igneous strata; II - small chalk streams with low rainfall; III - lowland limestone and sandstone streams (see Table 3.1). The percentage fine sediment (sub 1-mm; likely to impact spawning if >14%) in the upper 30cm of the bed varies markedly across the catchment types (<1% to nearly 70%). Thirteen of the 20 Type I sites had <10%; 10 of the 11 Type II sites had >30%; and all of the 20 Type III sites had >10% (with 4 sites having > 30%). However, 80% of the sub-1mm fraction at Type II sites was medium sand (0.125-1mm). The silt-clay (<0.063 mm) proportion varied from 3.5% (Type I) to 4.9% (Type II) to 7.4% (Type III), though some sites contained over 10%. Interestingly, Milan et al (2000) found that 'framework-supported' gravels with a low percentage of fine material are typical of high energy streams with mean unit stream powers in excess of 150 W m⁻² (Figure 3.17).

Table 3.1 Percentage of fine sediment in the upper 30cm of the channel bed (after Milan et al., 2000).

Size Fraction	Type I stream (n=20)	Type II stream (n=11)	Type III (n=20)
Sand (0.063-2mm)	11 (6.5-16.5)	42 (28.0-64.1)	21.5 (9.5-43.0)
Coarse sand (1-1.9mm)	5	4	6
Medium sand (0.125-0.99mm)	6	38	16
Fine sand (0.063-0.124mm)	1	1	1.5
Silt (0.004-0.062mm)	3.5 (0.6-7.3)	4.9 (0.9-8.1)	7.4 (2.0-18.0)
Clay (<0.0039)	0.6 (<0.1-1.9)	0.6	1.7 (0.3-5.2)

Such relationships may indicate potential to predict potential low-sediment high-quality habitats through entire river systems partly from catchment-scale stream power models, such as CASSP and the CAFES system developed by Lawler (1992) and Barker et al. (2009) (see 3.3.4).

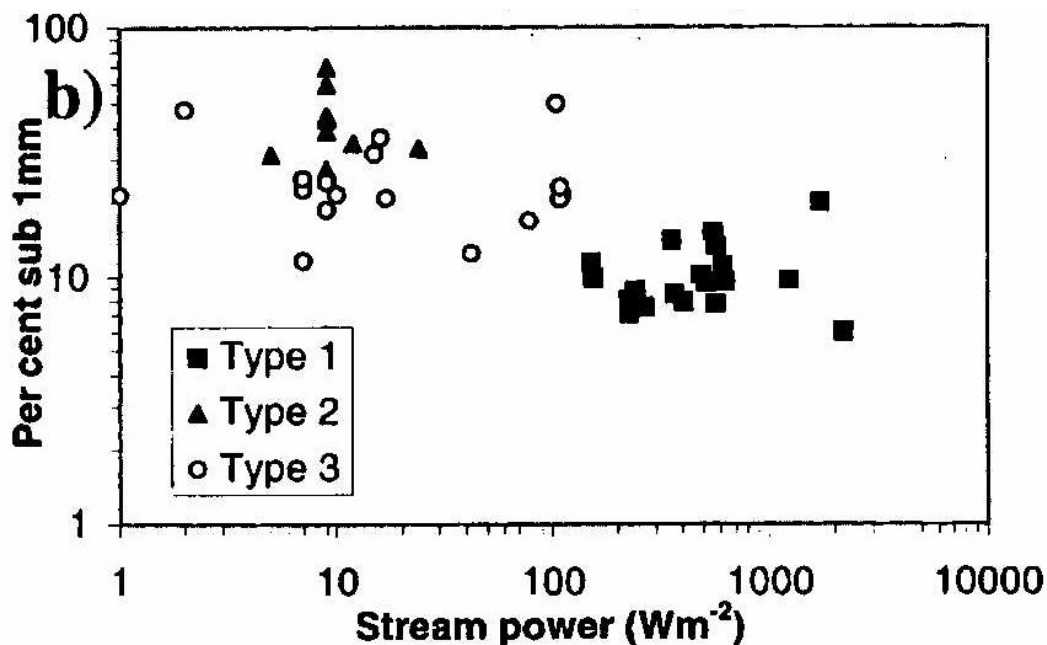

Figure 3.17 Relationship between stream power and percentage sediment sub-1 mm in upland (Type I), small chalk (Type II) and sandstone/limestone (Type II) streams (source: Milan et al., 2000).

Spatial and temporal variability in rates of siltation is important. Table 3.2 illustrates the low siltation rates of upland systems in England under baseflow conditions, and higher rates under similar flow conditions in lowland chalk streams. Siltation rates immediately below impoundments appear to be low due to sediment trapping effects. Acornley and Sear (1999) monitored monthly siltation rates in the River Test (Hampshire) using gravel-filled infiltration baskets and found low rates during low summer flows and higher rates during peak flows in late winter/early spring (Table 3.2 and Figure 3.18) (though significant velocity-related lateral variation in rates of siltation complicated the picture). However, position in the catchment may be significant here: in the Upper Piddle, for example, Walling and Amos (1999) found, at upstream sites, that summer deposition rates decreased (much as Acornley and Sear (1999) observed) whereas, at downstream sites, rates *increased* through spring and early summer 1992,

reflecting the progressive downstream transfer of sediment. This reinforces the need for catchment-scale approaches.

Table 3.2 Observed siltation rates for selected UK rivers.

Location	Flow	Siltation (kg m⁻² day⁻¹)	Reference
Upland rivers in England	Baseflow	0.008	Carling and McCahon (1987)
Little Stour		0.389	Wood and Armitage (1999)
Tadnoll Brook, Dorset		0.37-0.93	Welton (1980)
North Tyne, Northumberland	Hydropower discharge	0.004-0.064	Sear (1993)
	Compensation flow	0.005-0.086	
River Test, Hampshire	Low summer flows	0.02	Acornley and Sear (1999)
	Peak flows in late winter/early spring	0.5-1.0	

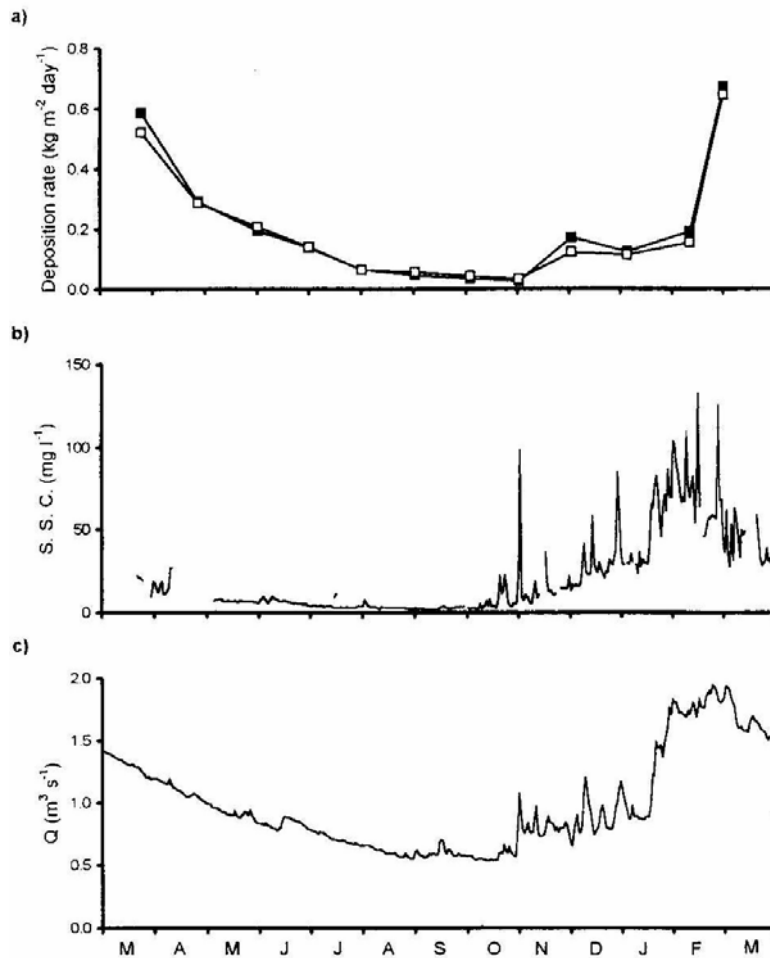

Figure 3.18 Temporal variation in a) average deposition rate of material finer than 4mm across each section b) daily suspended sediment concentration and c) mean daily discharge. Solid squares represent upstream traps and open squares represent downstream traps (source: Acornley and Sear, 1999).

3.7.8 Surface siltation

Surface siltation (top 5cm of river bed) is usually quantified using the resuspension technique (Lambert and Walling, 1988) or through mapping. Fine sediment storage at the bed is highly variable within and between rivers: reported amounts for UK rivers range from 120 to 9240 g m⁻² (Table 3.3). The amount of fine bed sediment storage represents a significant part of the annual sediment load of many UK rivers (e.g. 57% for River Piddle and 18% for River Frome; 17% for Rivers Ouse and Wharfe and 7% for River Tweed (Table 3.3).

Table 3.3 Fine sediment storage on the bed of selected UK rivers.

Location	Fine sediment storage (g m ⁻²)	Reference
Frome (main stem)	410-2630 (mean = 918)	Collins and Walling (2007a)
Piddle (main stem)	260-4340 (mean = 1580)	
River Tweed	120-960	Owens et al (1999)
Yorkshire Ouse	170-9240	Walling et al (1998)
Upper Tern Rivers Pang and Lambourn	860-5500 470-2290	Collins et al (2005)
River Exe	400	
River Severn	630-8000	Lambert and Walling, 1988
		Walling and Quine (1993)

The extent of fine sediment deposits are often controlled by macrophyte growth (e.g. Cotton et al., 2006). Although seasonal trends may be identified at individual sites there are few consistent patterns in bed sediment storage across sites and this is likely to be due to the interaction of several factors in a site-specific manner (Collins and Walling, 2007b). Few data exist on sedimentation during individual storm events; however, fine sediment mobilisation from the bed may occur early in the storm according to the first-flush model (i.e. positive hysteresis), or be mainly suspended after the flow peak after bed break-up, which may produce a negative hysteresis relationship (e.g. Lawler et al., 2006).

3.7.9 Sediment quality

Pollutants in surface waters originating from agricultural and urban/industrial land are often associated with fine sediments (<63 µm). Fine bed sediments play an important role in the temporary storage or fate of nutrients and pesticides and other contaminants (e.g. Owens and Walling, 2002). Hence, the pollutant attenuation capacities of hyporheic sediments are extremely relevant to environmental management (see Booker et al., 2008).

The organic content and particle size distribution of fine bed sediments are relevant to contaminant transfer and pose risks to habitats (see Table 3.4). Fine river bed sediments with a high organic content are likely to deplete oxygen within gravels (see section 3.7.3). Gravels with greater than 10% of sediment sized <1mm have been classed as poor habitat in the Favourable Condition Tables of the Habitat and Species Directive (Naden et al., 2003). Information on the particle size of interstitial fine sediment (<125 µm) from a wide range of UK rivers is presented in Walling et al. (2003). The mean content of particles <63 µm ranged from 49 to 89%. Acornley and Sear (1999) found for the River Test, Hampshire, that the particle size distribution of deposited sediment closely matched that of the suspended sediment, and that sediment deposited in summer was finer (Table 3.4 and Figure 3.19).

Table 3.4 Characteristics of fine river sediments from selected UK rivers.

River	Sediment type	Organic content (%)	Particle size distribution (%)				Reference
			Sand (0.063-2mm)	Silt (0.004-0.062mm)	Clay (<0.0039mm)	Other	
Upland streams (impermeable strata)	Upper 30 cm of channel bed		23	3.5	0.6		Milan et al (2000)
Small chalk streams with low rainfall			85	4.9	0.6		
Lowland limestone and sandstone streams			45	7.4	1.7		
River Test	Accumulated sediment from artificial redd	19.7 of <2mm				10% <2mm	Greig et al. (2005a)
River Aran		7.5 of <2mm				15.7% <2mm	
River Ithon		5.3 of <2mm				28.9% <2mm	
River Blackwater		3.4 of <2mm				12.2% <2mm	
River Frome, Dorset	Suspended	5-60					Farr and Clarke (1984)
River Test, Hampshire	Suspended	25-40 during summer and autumn low flows. 15-25 winter and spring high flows.					Acornley and Sear (1999)
	Bed sediment					Summer low flows (Jun-Sep) suspended sediment (<0.25 mm) accounted for 70-90%. Autumn floods (Oct) coarser sediment (0.25 – 4mm) accounted for more.	
Upper Piddle, Dorset	Fine bed sediment	12.2					Walling and Amos (1999)
Little Stour	<250um surficial fine sediment	13.8 (S.D. 4.35, n=51)				Spatially and temporarily consistent (D50=58.75 um; S.D. 6.25)	Wood and Armitage (1999)

Table 3.5 Provenance of river bed fine sediment in selected UK catchments.

River	% sediment derived from each given landuse				Other sources	Reference
	Pasture	Cultivated	Woodland	Channel banks/ subsurface		
Chalk streams					Material from within channel (autochthonous) dominates during summer flows. Material from surface runoff (allochthonous) dominates during winter flows.	Mainstone (1999)
River Frome					Autochthonous and allochthonous particles under macrophytes. Instream deposits of organic material depend on algal productivity, microbial activity and production of faecal pellets	Cotton et al (2006)
River Frome	10+/-2 to 42+/-2	44+/-4 to 81+/-2	1+/-1 to 6+/-2	7+/-2 to 19+/-4		Collins and Walling (2007c)
River Piddle	10+/-2 to 28+/-4	44+/-2 to 80+/-2	1+/-1 to 11+/-4	7+/-2 to 21+/-2		
Upper Piddle					Surface soils (cultivated areas) as opposed to channel banks, permanent pasture or instream detritus	Walling and Amos (1999)
Upper Tern	35+/-5	51+/-5		14+/-3		Collins and Walling (2007b)
River Pang	49+/-8	33+/-5		18+/-5		
River Lambourn	19+/-6	64+/-5		17+/-5		
Essex River					Road construction	Extence (1978)
River Tame					Urban landuse	Thoms (1987)
Rivers in Wales					Mining	Turnpenny and William (1980)
Plynlimon catchments					Forestry	Leeks and Marks (1997)

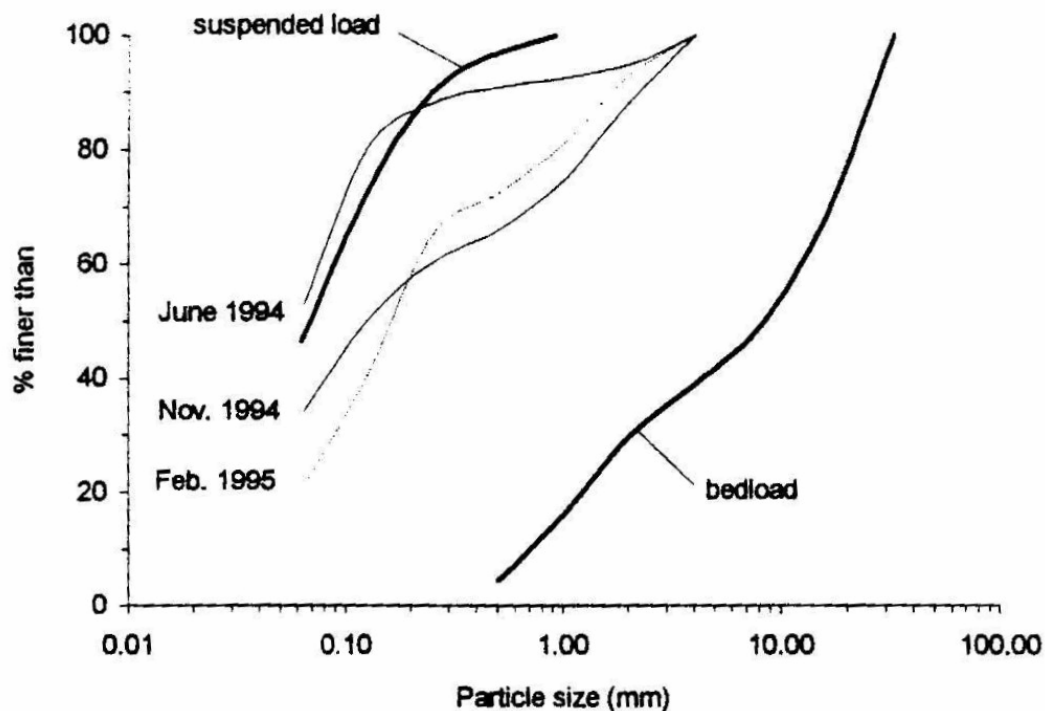

Figure 4.19 Average particle size distributions of fine sediment deposited in June, November and February. Representative distributions are also presented for the suspended load and bedload in the study reach (source: Acornley and Sear, 1999).

3.8 Conclusions

Geomorphological impacts on the operation of the hyporheic zone, especially the role of interacting fluvial and sedimentological processes and forms, represent an important emerging science. Geomorphological effects are readily apparent at multiple spatial and temporal scales which are often linked. For example, sediments, nutrients and contaminants important for the stability, disturbance, quality and maintenance of hyporheic zone habitats, can be delivered to the site from the basin or upstream reaches. Sources of the problem may be a long distance from the site.

Alongside processes, it is also important to consider longer timescale histories. For example, rivers tend to be much more dynamic and coarse-bedded in northern and western Britain, linked to recent glaciation, and these rivers, *all things being equal*, may be associated with higher hydraulic conductivities and increased potential for near-bed flow exchanges. However, in addition, many chalk streams with major groundwater-surface water interactions are in the south and southeast.

Rivers change strongly in a downstream direction, especially in channel geometry, materials and erosional and transportational energy, so management solutions with proven workability for lower reaches may not be appropriate for upper reaches and vice-versa. At reach and site scales, hyporheic exchanges are driven primarily by topographic features and changes in bed permeability, especially the presence of riffles and sedimentological heterogeneity. Plan-form irregularities, such as meanders (and even subtle changes) induce hyporheic exchange.

Fine sediment in river beds (often the sub 1-mm fraction) is increasingly recognised as a problem ecologically, and can represent 1 - 70% of total river bed material; 14% has been suggested as a threshold figure for impact on spawning but more work is required here to test the generality of this. Clogging of gravel matrices by colmation processes can significantly reduce water velocities across, and oxygen supply to, fish eggs. Such processes can be modelled empirically or, increasingly, analytically: for example, the SIDO model (Sediment Intrusion and Dissolved Oxygen) simulates the processes of sediment transport and infiltration into a redd, the supply rate of oxygen transported through the gravel bed, egg oxygen consumption and temperature dependence.

Sediment quality is crucial: fine bed sediments play an important role in the temporary storage or fate of nutrients and pesticides and other contaminants. Hence, pollutant attenuation capacities of hyporheic sediments are seen as an increasingly important area in river management.

4 Water and unreacting solute flow and exchange

4.1 Summary of key messages

1. Flow systems in permeable river/aquifer interface zones in temperate climates can be characterised by combinations of the following attributes:
 - a. discharge from regional groundwater systems directly or indirectly to the river channel
 - b. discharge from a river channel or floodplain into the ground
 - c. 'spiralling' of river water down into and up from, and laterally into and out of, surrounding deposits, a process initiated by obstructions in the channel (variations in riverbed topography, logs, weirs) and by channel meanders and bends: i.e. highly spatially variable flow pathways, 'nested' from sub-metre to regional aquifer scale
 - d. pathways and fluxes varying in time, responding to changes in river stage, vegetation, temperature, and sediment discharges
 - e. long tailing of solute breakthrough residence time distributions for most scales of flow path, even in the absence of permeability heterogeneity.
2. For low permeability systems, direct exchange flows via river beds, either from the regional groundwater system or from surface waters up-stream, will often be unimportant.
3. Exchange flow distributions in fractured, and especially karstic, systems will often be localised, unless alluvial deposits are sufficiently developed to diffuse the flow.
4. Flow system nesting and its spatial and temporal variability is important for all aspects of site investigation, from planning of sampling through discharge estimation, to solute attenuation evaluation and ecological interpretation.
5. Given the possible small scale heterogeneity of the processes, it is important that site-specific conceptual models are developed. However, even with site specific conceptual models, the accuracy of prediction of flow and solute transport is likely to be limited (despite the fact that flow is the simplest of the systems in the hyporheic zone!).

4.2 Introduction

The aims of this review are to summarise the present state of knowledge of river/aquifer water and unreacting solute exchange processes, and to provide an indication of where further information can be found.

It is intended that the principles covered will allow a reader to develop conceptual models for specific cases. These conceptual models are the first stage in quantification (Chapter 9), inform the planning of field investigations, and form the basis for qualitative decision-making.

A basic knowledge of groundwater flow and transport theory and of hydrology is assumed, as well as knowledge of the principles covered in Chapter 3 (Geomorphology), though a glossary is included at the end of the chapter. The review focuses on temperate climates, discharge from aquifer to river, and permeable,

intergranular-flow river bed deposits. There are several useful reviews of hyporheic flow systems, including those contained in Sophocleous (2002), Smith (2005), and Woessner (2000).

In this review, the zone in which surface water and groundwater interact will be termed the surface water/groundwater interface zone (SGIZ) to avoid any unintended connotations which may arise through use of the term 'hyporheic zone'. Movement of water and solutes between river and groundwater, whichever the direction, will be termed exchange fluxes or flows.

Natural flow systems are often scale-dependent, and this is particularly the case in the SGIZ. Therefore exchange fluxes will often vary significantly in space and time, with the variation itself spatially variable: the flow systems are often strongly four dimensional. Hence the review is structured to reflect scale, starting at the catchment/ longer time scale (Section 4.3), moving through reach scale (Section 4.4), and ending with the bedform/short time scale (Section 4.5) (*cf.* Dent et al., 2001). However, defining the upper and lower limits of reach scale will be left purposely vague, as variation is continuous and boundaries, if they indeed need to be considered, may be better set at different absolute limits in different systems, or even the same system at different times. Sections 4.4.5 and 4.4.6 deal with a range of processes occurring at several scales and river bed permeability respectively. A concluding discussion on flow systems (Section 4.8) is then followed by an outline of solute transport processes (Section 4.9).

In order to use this review to develop site-specific conceptual models, it is likely that the reader will need to read through all the sections. The nested-scale nature of river/aquifer exchange flow makes it difficult to produce a useful set of pre-developed conceptual models for all the cases likely to be encountered.

4.3 Catchment Scale Flow

4.3.1 Catchment Water Balance

The water balance for a river catchment (i.e. surface catchment plus associated groundwater system) can be expressed as:

$$P + GWI - SWO - ET - Q - GWO = \Delta S \quad (1)$$

where: P = precipitation; GWI = groundwater inflow from adjacent aquifers and the sea; SWO = surface water outflow (i.e. river flow); ET = evaporation and transpiration; Q = surface water and groundwater abstraction; GWO = groundwater outflow to other aquifers and to the sea; and ΔS = change in amount of surface water and groundwater stored; all terms are expressed as volumes per unit time or volumes/total catchment area per unit time. These components can be estimated using standard techniques (see Chapter 8), often implemented in regional groundwater and/or surface water flow numerical models (see Chapter 9).

In many systems in temperate climates the dominant discharge term in the catchment water balance is the river flow (SWO), and most groundwater (and its solute load) discharges to rivers, either directly into the river channel or via wetlands, streams, or ditches tributary to the river.

4.3.2 Channel Flow Components and Their Timings

The surface water outflow term in Equation (1) can be split into four main components:

$$SWO = P_d + OLF + IF + GWD \quad (2)$$

where: P_d = direct precipitation (i.e. precipitation landing on the river), minus any evaporation; OLF = overland flow; IF = interflow, i.e. shallow groundwater above the main saturated level that finds its way to the channel; and GWD = groundwater discharge from the saturated zone of an aquifer. These components are not necessarily independent of each other. Increase in rainfall may cause rise in groundwater levels and hence increased GWD and OLF and, if the water table rises sufficiently, IF may be subsumed in GWD . As each flow component will have a different chemical composition, the chemistry of the river water will be affected by the relative size of each of the components.

Another form of Equation (2) is

$$SWO = QF + BF \quad (2A)$$

where QF = quick flow (or event flow), i.e. the flow resulting almost immediately from precipitation events, and BF = baseflow, the flow entering the surface water body from more slowly-varying sources. Thus, in many systems P_d , OLF , and IF contribute to QF , and GWD dominates BF . It is the BF component that maintains river flows when precipitation has ceased. Average residence times for groundwaters in a catchment may be hundreds or even thousands of years, whereas even for some of the largest UK rivers, in-channel residence times will average only a few days. However, where rapid rises in groundwater level occur following rainfall events (i.e. in areas of low storage coefficient), a component of the groundwater from the saturated zone may be discharged quickly.

The disparity in time scales for different channel flow components has major implications for surface water quality variation, and different seasons and even different parts of the same precipitation event may be associated with different water quality. On a larger time scale, changes in groundwater recharge quality may impact river quality in some cases only after a considerable delay, possibly of decades.

4.3.3 Baseflow Variation in Time

Systems with fast (high) aquifer response times ($ART = transmissivity / [storage\ coefficient \times representative\ length^2]$; e.g. Downing et al. (1974)) produce more 'flashy' base flows (e.g. UK chalk), whereas systems with slow (small) ART s (e.g. the UK Permo-Triassic sandstones) produce base flow discharges that are more constant throughout the year (Figure 4.1).

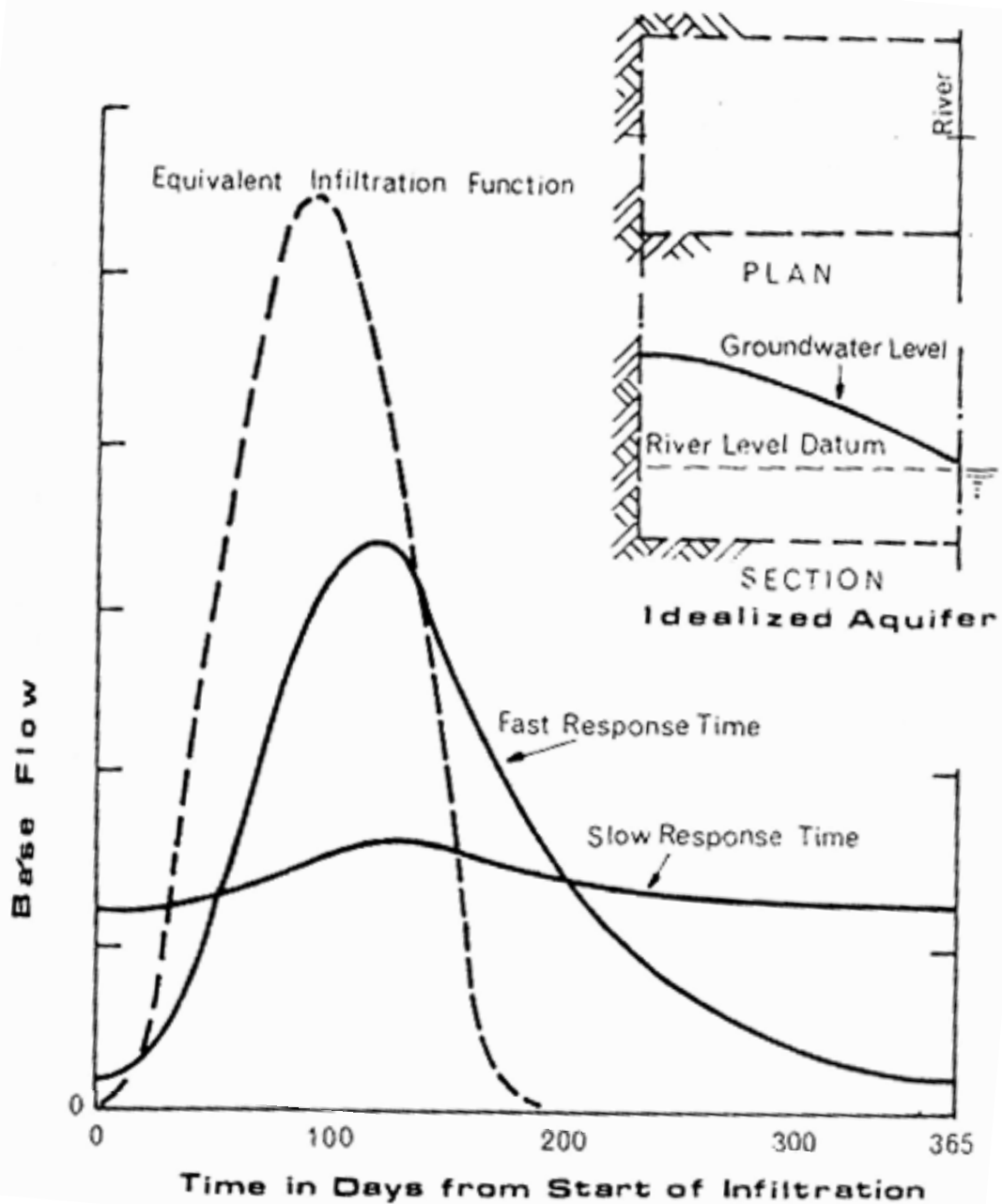

Figure 4.1 Schematic hydrographs for streams in continuity with aquifers of fast (e.g. chalk) and slow (e.g. sandstone) aquifer response times (Downing et al., 1974).

4.3.4 Baseflow Relative to Total River Flow

Often in temperate climates, baseflow will form a very substantial proportion of river discharge. In this context, the 'baseflow index' (*BFI*) is a useful tool (e.g. Twort et al. (2000); see Chapter 3). *BFI* is the fraction of river flow that comes from 'stored sources', the latter being groundwater including soil-derived water. In practice, it is evaluated using a fairly basic hydrograph-separation method and, in the UK, the Centre

for Ecology and Hydrology produces *BFI* values for most of the UK river gauging stations. Table 4.1 summarises the ranges of *BFI* values for rivers overlying various stratigraphic units in the UK. It can be seen that for permeable catchments most of the river flow is supplied by baseflow (e.g. in the case of chalk), but even in clay catchments (e.g. London Clay), the proportion of flow derived from baseflow/stored sources is still significant. Note that baseflow can have slightly different meanings in different contexts.

Table 4.1 *BFI* value ranges for UK. Modified after Twort et al. (2000)(a) and Sear et al. (1999)(b).

	(a) <i>BFI</i> Range	(b) Mean
London Clay (Tertiary)	0.15-0.46	0.38 ('soft clays')
Chalk (Cretaceous)	0.9-0.98	0.83
Upper Jurassic Limestones	0.85-0.95	
Oxford Clay (Jurassic)	0.15-0.45	0.38 ('soft clays')
Lower Jurassic clays and limestones (Lias)	0.4-0.7	
Permo-Triassic Sandstones	0.7-0.8	0.68
Coal Measures (Carboniferous)	0.4-0.55	
Millstone Grit (Carboniferous)	0.35-0.45	
Carboniferous Limestones	0.2-0.75	0.42 ('hard limestones')
Devonian Sandstones	0.45-0.55	
Metamorphic and Igneous	0.3-0.5	0.49

4.3.5 Regional Effects of Rivers on Groundwater Flow Patterns

Where an extensive regional aquifer is present, groundwater catchments are often approximately coterminous with surface water catchments, reflecting the fact that groundwater levels are often 'subdued reflections of the topography'. Groundwater will flow from the watersheds towards discharge locations on the valley sides and bottoms (Figure 2a). However, groundwater catchments sometimes differ from the associated river catchments. This obviously happens where the aquifer is smaller than the surface water catchment, but can also occur where the aquifer extends beyond the surface catchment – the groundwater divide may lie inside or outside the surface watershed. River valleys, representing the lowest elevations in a catchment, have a major, and often *the* major, effect on regional groundwater flow patterns, especially in the absence of significant groundwater abstraction. Conceptually, a typical river in a zone of temperate climate can be viewed as the surface expression of the groundwater table – a groundwater outcrop – at least in its lower reaches.

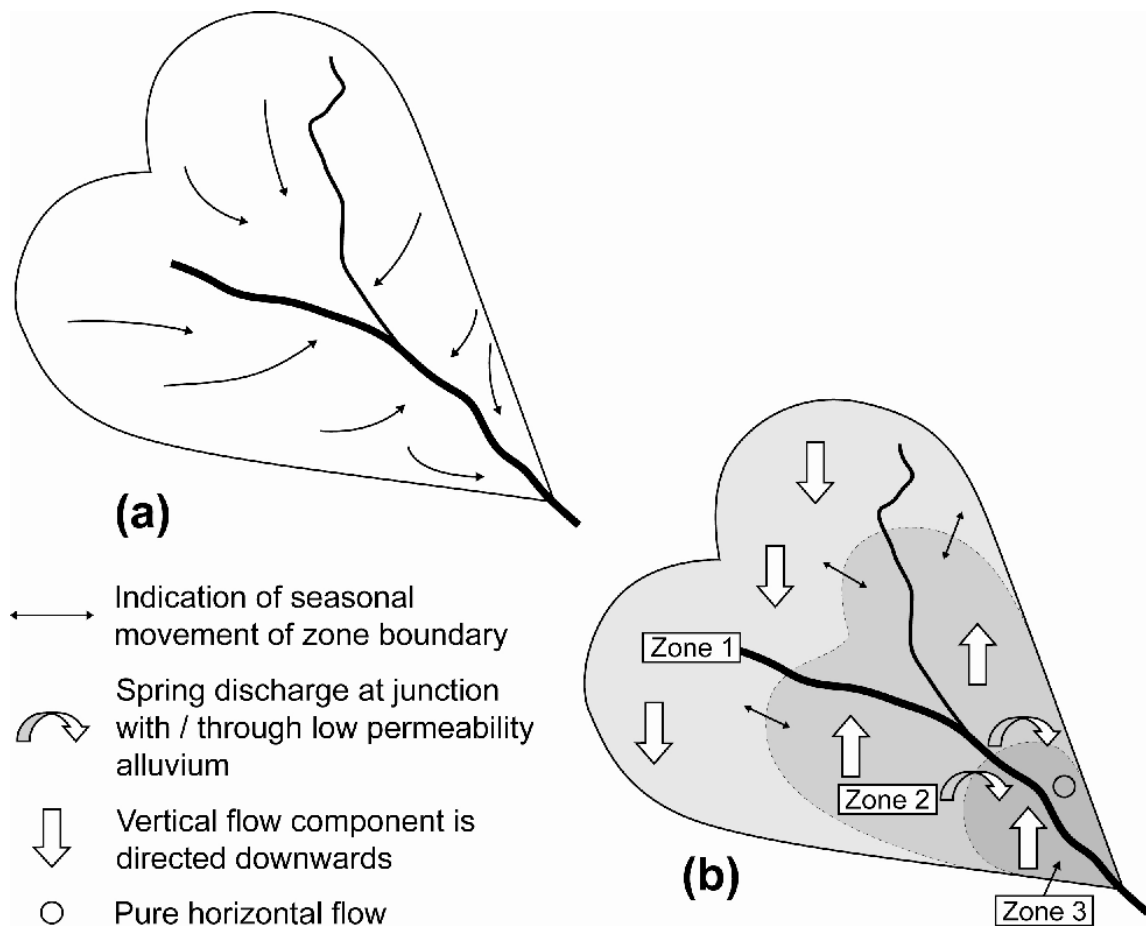

Figure 4.2 Cartoon of a river catchment in an area of temperate climate showing the general groundwater flow patterns: (a) horizontal components (b) vertical components. In (b) spring discharges may occur on valley sides.

The relationship between rivers and groundwater flow patterns is not just seen in horizontal groundwater flow path distributions (Figure 4.2a). In the upper reaches of a catchment, the groundwater flow systems are likely to have a downwards-directed component (Figure 4.2b), and rivers are often perched and ephemeral where they lie above permeable rock sequences. In the mid-reaches, baseflow is much more common, i.e. there is an upward-directed component to groundwater flow, at least locally around the river (Figure 4.2b), and here the river is likely to be perennial. The location of the boundary between the upper influent (river to groundwater) and lower effluent reaches may change considerably seasonally (see Section 4.4.3). Likewise, the zone immediately adjacent to the river may experience rapidly varying water levels meaning that during wet periods, discharge to surface may occur over a zone wider than the river channel itself (see Section 4.4.9). In lower reaches, the ground surface gradients are often small and the alluvial deposits of low permeability. Often irrespective of season, this gives rise to inefficient discharge diffused over large areas with some focussing on the valley sides where topographical gradients decrease onto the flood plains.

Within the zone where the main water table intercepts the ground surface (i.e. Zones 2 and 3 in Figure 4.2), if the aquifer is deep enough, the groundwater flow patterns will be 'nested', with local, small-scale flow cells feeding up-stream discharges, and regional, deep flow feeding the major river channels (Figure 4.3).

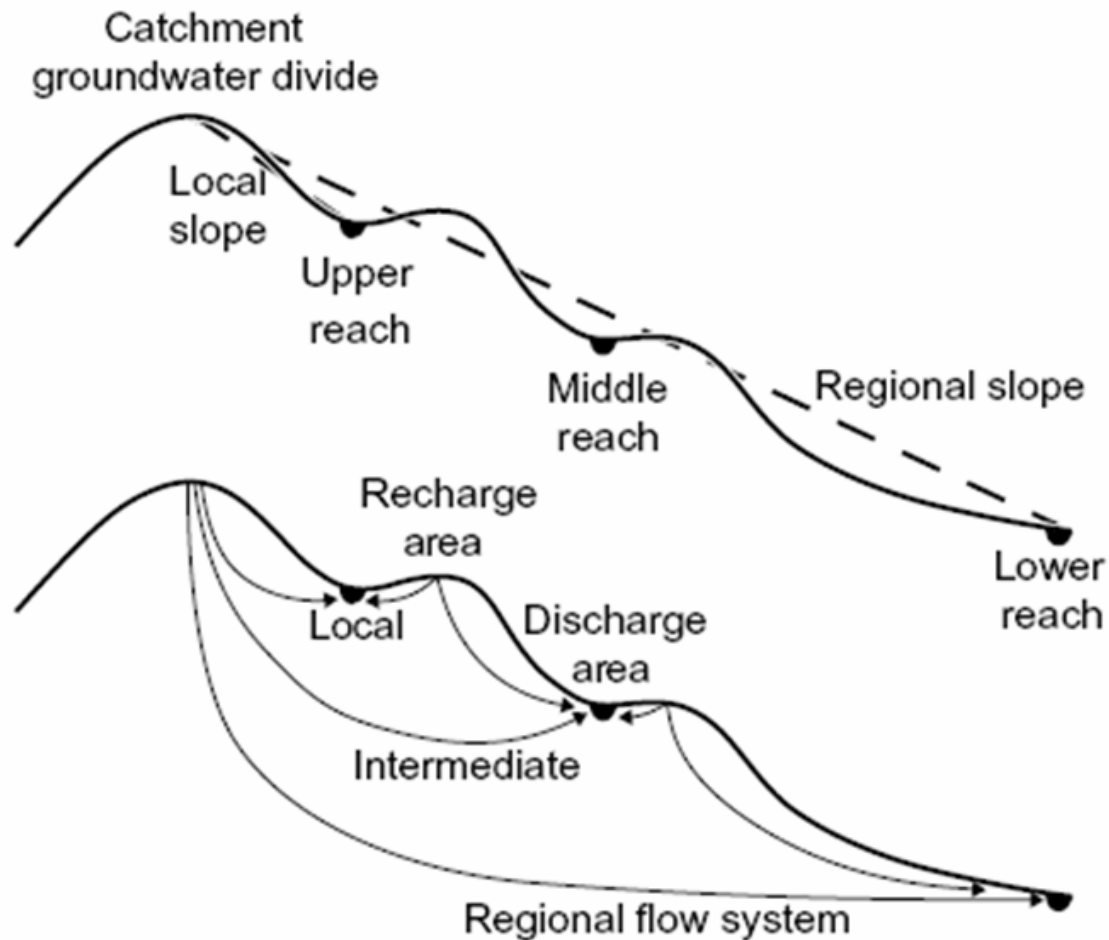

Figure 4.3 Nested flow systems in areas of complex topography [Dahl et al. (2007) after Toth (1970)].

Therefore there are three main zones of a typical temperate zone river: an upper-reach, flashy, influent zone (Zone 1, Figure 4.2); a mid-reach, damped, effluent zone (Zone 2); and a lower reach, damped, wide zone of diffuse discharge (Zone 3).

So far only regional unconfined aquifers have been considered. However, in other cases, aquifers are confined by overlying deposits and only communicate significantly with rivers in locations where the river has eroded through the intervening aquitard.

4.4 Reach Scale Flow

4.4.1 River Channels from Headwaters to Mouth

Proceeding in a downstream direction, rivers usually display (Chapter 3):

1. lower axial and transverse gradients
2. an increase in depth and width/depth ratio
3. an increase in sinuosity
4. a decrease in bedload to total sediment load
5. a decrease in sediment load grain size
6. an increase in discharge.

Of these, 1, 2, 3, and 6 are important in affecting hydraulic boundary conditions, and 4 and 5 in affecting substrate permeability, these being the main determinants of

river/groundwater exchange flows, as explored in this (Section 4.4) and the following section.

4.4.2 Geometrical Relationships Between Rivers and Underlying Groundwater Flow Patterns

Figure 4.4 shows the few possible geometrical relationships between rivers and underlying groundwater flow patterns (Woessner, 2000). These relationships will change from river headwaters to mouth (Section 4.3; Figure 4.2), and may change also in time depending on variations in the difference between water table and river surface elevation.

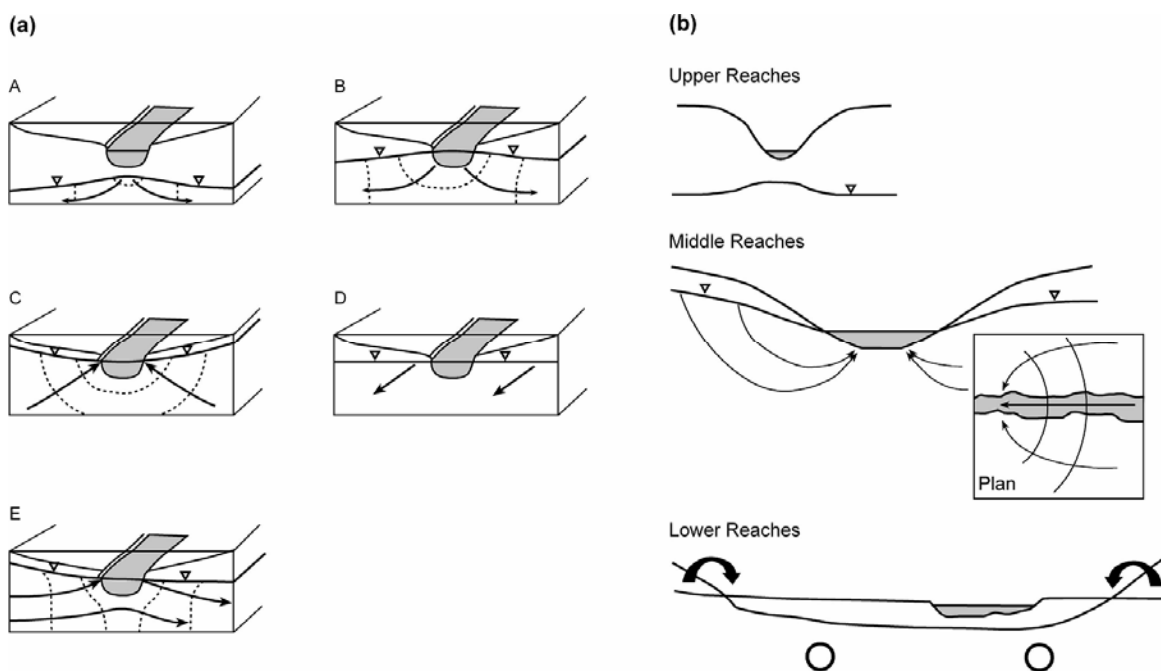

Figure 4.4 The possible geometrical relationships between rivers and groundwater flow. (a) geometrical classes A to E discussed in the text. After Woessner (2000). (b) typical geometrical relationships from head water reaches to lower reaches (circles indicate flow out of the page).

4.4.3 Flows between Headwater Reaches and Groundwater Systems

In the headwaters of a river (Figure 4.2a, Zone 1), influent flow is more likely, either with an unsaturated zone between the river and the table (Figure 4.5, A) or, further downstream where the depth to the water table is smaller, without (Figure 4.5, B).

There has been some work on Case A (intervening unsaturated zone; Sophocleous, 2002), but much more work has focussed on predicting losses from the related problem of 'perched' canals. At some point, further lowering of the water table will result in little further increase in flow, a point that may be around twice the channel width at least for homogeneous systems (Sophocleous, 2002). It is possible that in such cases 'unstable' unsaturated zone flow would become important, leading to flow in vertical isolated 'fingers'; in addition, 'funnelling' may also occur. Both processes result in more rapid transfer of water (and hence solutes) through the unsaturated zone, with parts of the unsaturated zone being relatively flow-inactive.

The location of the downstream limit of Cases A and B may change significantly with time (Figure 4.2b), especially if the axial gradient of the river and the aquifer storage coefficient are small. In the extreme situation where the aquifer is very permeable it will not be possible for a stream to exist perched above the water table. A good UK example of this are the 'bournes' of SE England where, with rising groundwater levels, the headwaters of chalk streams move up-slope, occupying valleys previously dry (see www.groundwaterUK.org). Many headwater systems, being on higher ground may be underlain by harder, less permeable rocks, and in these cases there may be only the shallowest of groundwater systems, perhaps in a thin cover of weathered bedrock. In many cases, these will be effectively saturated pockets of sediment that will dry out only when the river has stopped flowing.

4.4.4 Flows Between Mid-Reaches and Groundwater Systems

In mid-reaches (Figure 4.2b, Zone 2), Cases C (effluent flow) and D (parallel underflow) of Figure 4.4 become more likely: Figures 4.5a and 4.5b show the horizontal flow components corresponding to these two cases. These are extremes, and in many cases flow will be at an angle to the river (Figures 4.4b and 4.5c); river cross-sections ideally are better drawn along flow lines rather than perpendicular to the river axis – the system is inherently 3D, rather than 2D (Larkin and Sharp, 1992). In some situations, Case E of Figure 4 may obtain, with flow occurring across the channel, controlled by some discharge point below the elevation of the stream channel.

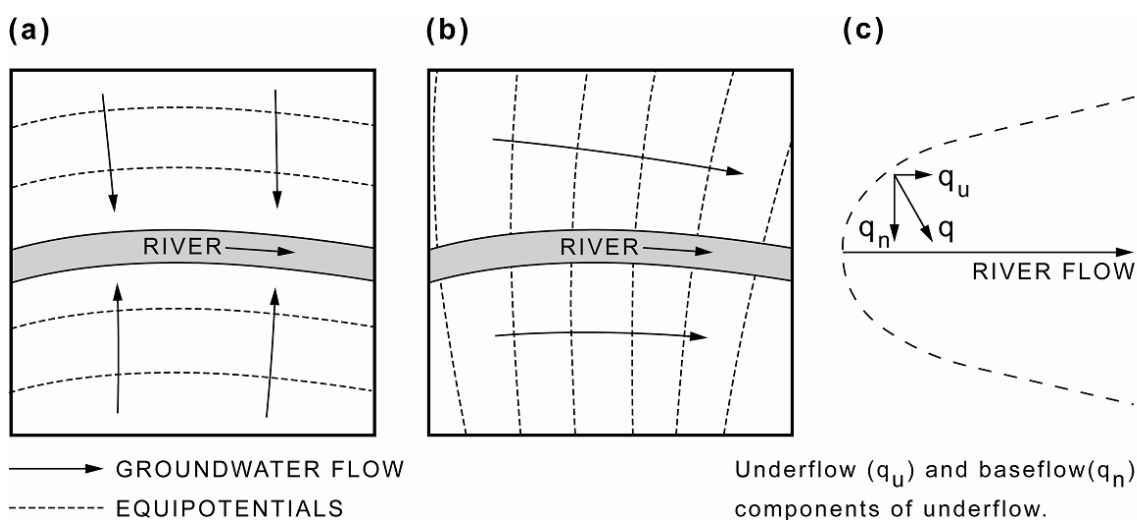

Figure 4.5 Groundwater flow (a) perpendicular to and (b) parallel with a river channel. (c) the more general case with the flow direction intermediate between cases (a) and (b). After Larkin and Sharp (1992).

Modelling studies (Larkin and Sharp, 1992) have suggested that the effluent (baseflow) case (Figure 4.4, Case C) is favoured by:

- (i) smaller longitudinal channel gradient
- (ii) greater sinuosity
- (iii) smaller width/depth ratio
- (iv) greater penetration of river relative to aquifer base
- (v) greater river bed permeability, though only above a threshold
- (vi) greater aquifer permeability.

4.4.5 Flows Between Lower Reaches and Groundwater Systems

In the lower, wide, flat-bottomed reaches of a river (Figure 4.2b, Zone 3), the lower absolute elevations will often mean water tables are close to ground surface but discharges may be relatively small because of lower permeability alluvial deposits. In these circumstances, discrete discharges may be present only at the margins of the valley floor, some distance from the main river channel (Figure 4.4b). Depending on the permeability of the alluvium, regional groundwater discharge may be very limited, and aquifer flow under the channel may be parallel to the channel or even across it (Figure 4.4 Cases D and E, though without significant hydraulic connection), depending on what downstream discharge points are available, such as the sea. Where no downstream discharge is available, most flow will be upwards, at slow rates, but possibly distributed over large areas.

4.4.6 The Effects of Local Permeability Distributions

The type of aquifer has a strong effect on the style of groundwater discharge to a river, with discrete discharges more common in fracture-flow systems (such as the UK chalk), and diffuse discharges more common from more intergranular-flow dominated systems (such as the UK Permo-Triassic sandstones). Differentiating discrete flow from diffuse flow systems should be possible from stream flow gauging data, provided it is at high enough resolution (see Chapter 3), though in some cases alluvial or other superficial deposits will smooth out the effects of discrete fracture discharges. Floodplain deposits may also be very variable in permeability, especially where palaeochannels cut through overbank deposits (Chapter 3). This may result in fast pathways through generally lower permeability flood plain deposits (e.g. Sophocleous (1991)), and again result in discrete zones of discharge to the river channel despite the intergranular nature of the flow. Periodic river-bed outcrop of hard, low-permeability bedrock can result in forcing flows in alluvial sediments to discharge to the surface, as can laterally-constraining bedrock outcrop: once flow has passed the constriction, inflow into the alluvial sediments is again likely (Konrad, 2006). Finally, modelling studies indicate that permeability anisotropy can significantly affect flow patterns below rivers: the main effect is to skew the symmetric cross-sectional flow path patterns of isotropic systems, resulting in extreme cases in flows passing under the river before rising up and returning to discharge through the river bed (Fan et al., 2007; Ellis et al., 2007).

4.4.7 Effects of Topographic Variation in River Longitudinal Profiles

River beds undulate. At reach-scales, changes in bed gradient occur in response to variations in bedrock erosional resistance and sediment transport processes (Chapter 3), and are often manifest as riffle-pool-step sequences. In pool-riffle-step (or pool-step-riffle) sequences, riffles are often formed of gravel, and though pools may be underlain by finer sediments, both frequently have significant permeability. Riffles occur in UK rivers at spacings of around 6 times bankfull width (Chapter 3). Modelling studies and field monitoring and tracer tests have shown that because of the drop in head in the downstream direction, water will enter the river bed sediments at the local elevation highs (often the downflow part of a pool, and the riffle), flow through the sediment, and exit at local lows (the upflow part of the next downstream pool) (Figures 4.6 and 4.7; Harvey and Bencala, 1993; Gooseff et al., 2005, 2007). Thus where these features are developed the river beds have zones of downflow ('downwelling') and upflow ('upwelling'). The elevation changes causing the downflow and upflow also induce flow into and out of the river banks (e.g. Woessner, 2000). Such lateral flows were found by Storey et al. (2003) to involve greater fluxes than the vertical flows.

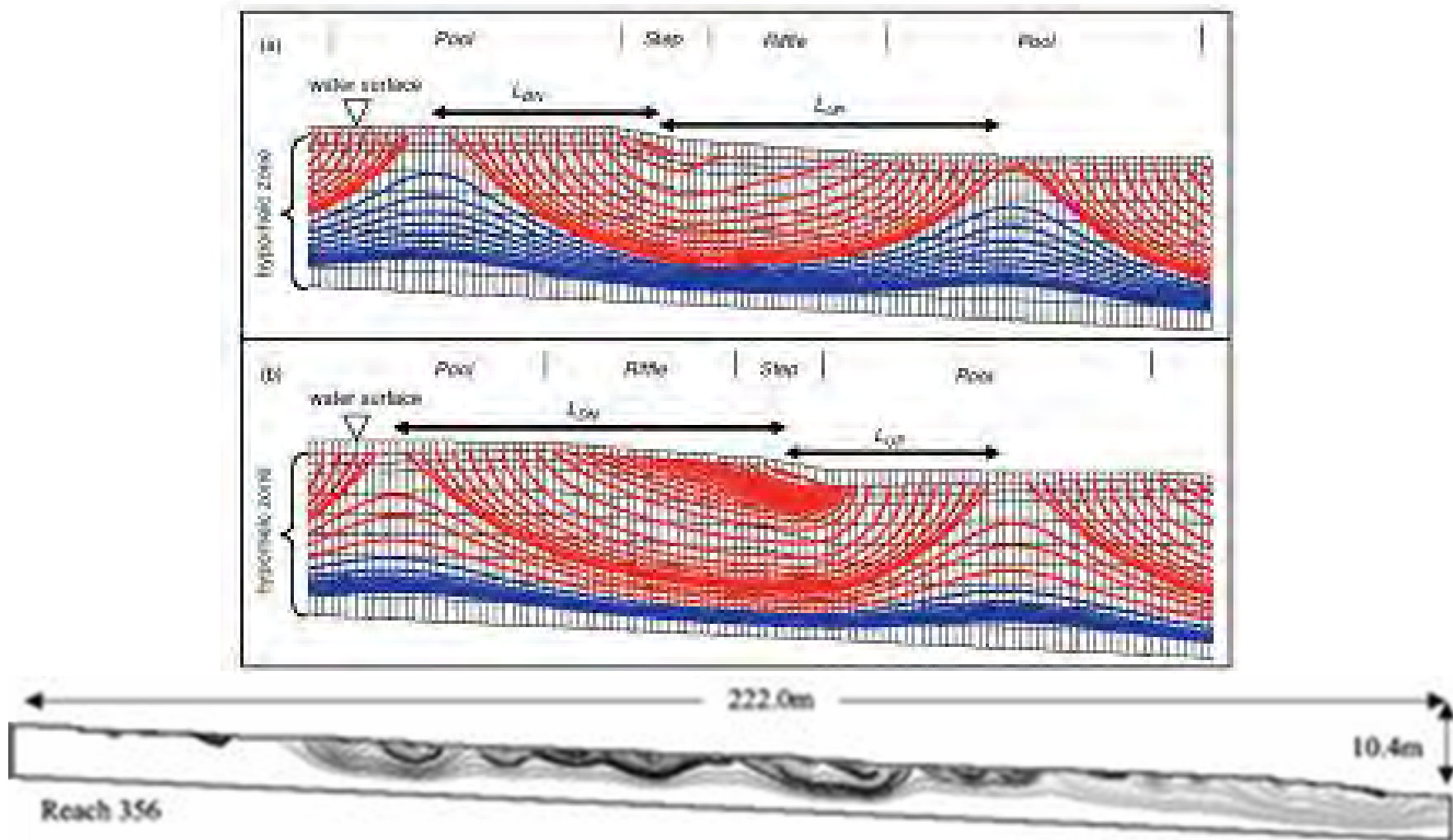

Figure 4.6 Modelling results for flows through pool-step-riffle and pool-riffle-step sequences of three reaches of Lookout Creek, Oregon, USA (Gooseff et al., 2005).

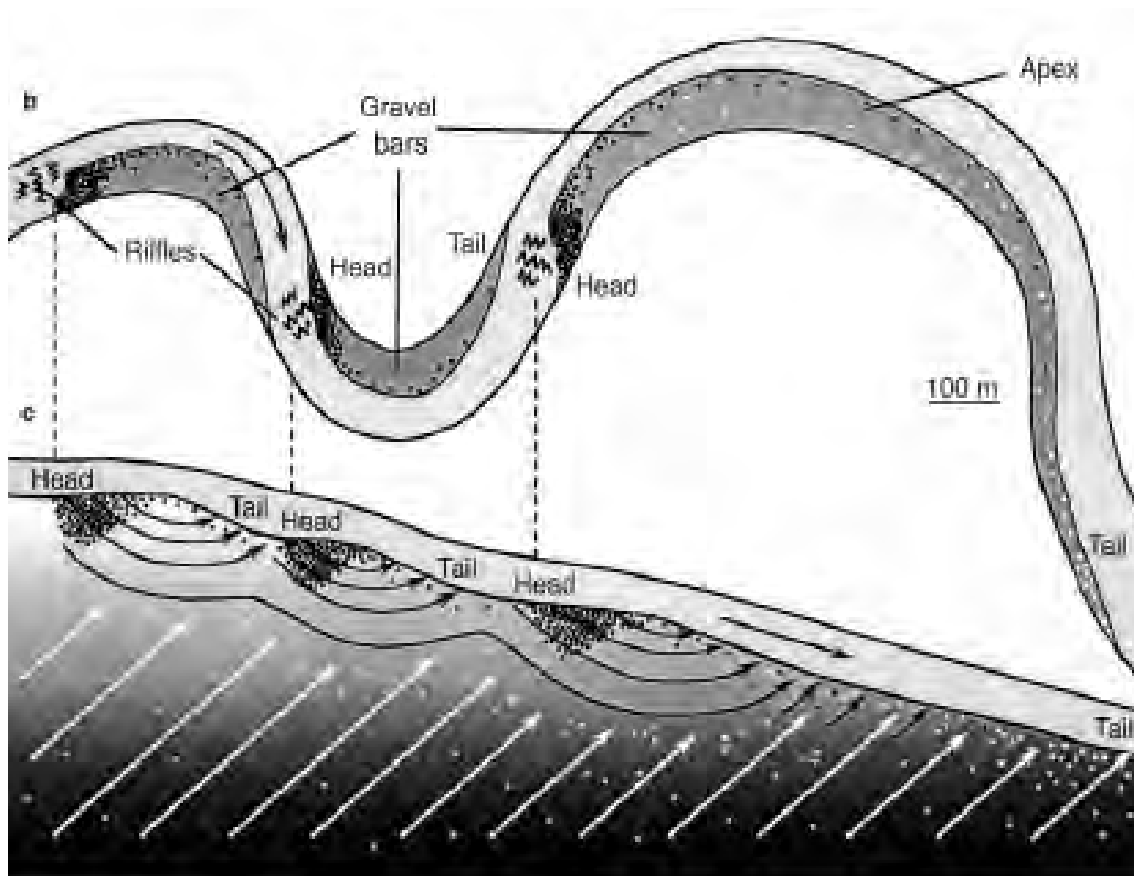

Figure 4.7 A conceptualization of river bed flows associated with riffled gravel bar reaches [Malcolm et al. (2003), after Malard et al. (2002)]. Only vertical flows are shown: in addition, there will often be lateral flows into the surrounding alluvium that pass around the riffle and emerge again into the channel downstream; there will also be flows that pass across the meander loop (see Figure 9). The deep groundwater discharges (white arrows) will either pass around the outside of the shallow flows or discharge between one gravel bar and the next [cf. Figure 14 (b)].

Riffles affect the stream water surface elevation, and Tonina and Buffington (2007) found riffle-associated exchange flows to be more sensitive to river water level than is the case for smaller bedforms (such as dunes: see Section 4.5.2). To model their experimental data, Tonina and Buffington (2007) also found it necessary to include representation of the third dimension, something that most modelling studies avoid, an exception being Storey et al. (2003).

Storey et al. (2003) undertook field and three dimensional steady-state groundwater modelling studies of a riffle-pool sequence in a stream in southern Ontario, Canada. They found that the main controls on SGIZ fluxes and pathways were hydraulic conductivity distribution, groundwater discharge, and head difference across the riffle, all three of which varied seasonally causing changes in fluxes up to thirty-fold (Figure 8). They also found that river-sediment-river exchange flows ceased when permeability was less than 1 metre per day (m/d), a value that would be considered reasonable for a water supply aquifer! (This point is worth emphasising, as most research has concentrated on relatively high permeability systems, and therefore gives a biased impression of likely flows in many SGIZ systems.) The model runs that reproduced the field-measured heads showed that a significant exchange flow system was present. Nevertheless, the total flux through the local SGIZ system was always less than 0.1%

of the stream discharge, and in winter less than 0.002% (compare this with estimates by Runkel (2002) for entire river lengths summarised in Section 4.9.2). Storey et al. (2003) also found that the greatest fluxes occur at the sides of the stream channel, and rather less through the centre (in their case, by a factor of between 4.5 and 16), a point also noted by other investigators.

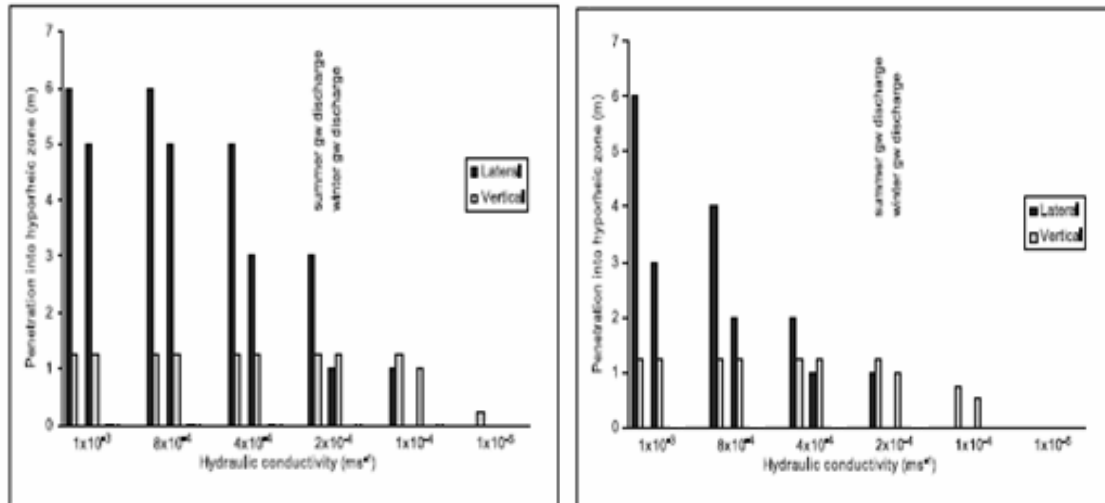

Figure 4.8 Vertical and lateral flows in the vicinity of a riffle in an effluent gravel-bed stream in Canada as modelled by Storey et al. (2003), showing sensitivity to bed permeability, groundwater discharge (winter = 2 summer), and head difference across the riffle. (a) head difference across riffle as in summer; (b) head difference across riffle as in winter (= half that for summer).

4.4.8 Effects of Meanders

Sinuosity has a major effect on local flow directions in the horizontal plane. Modelling work has shown (Boano et al., 2006; Cardenas, 2008a) that when considering only horizontal flows, groundwater flow occurs across meander loops as shown in Figure 4.9. Although these models are relatively crude representations, they show that in sinuous, non-headwater systems there can be both inflow and outflow over the same part of a channel (including as in Figure 4.4a, Case E). The flow systems have a significant effect on water residence times (Cardenas, 2008a), as outlined in Section 4.9.

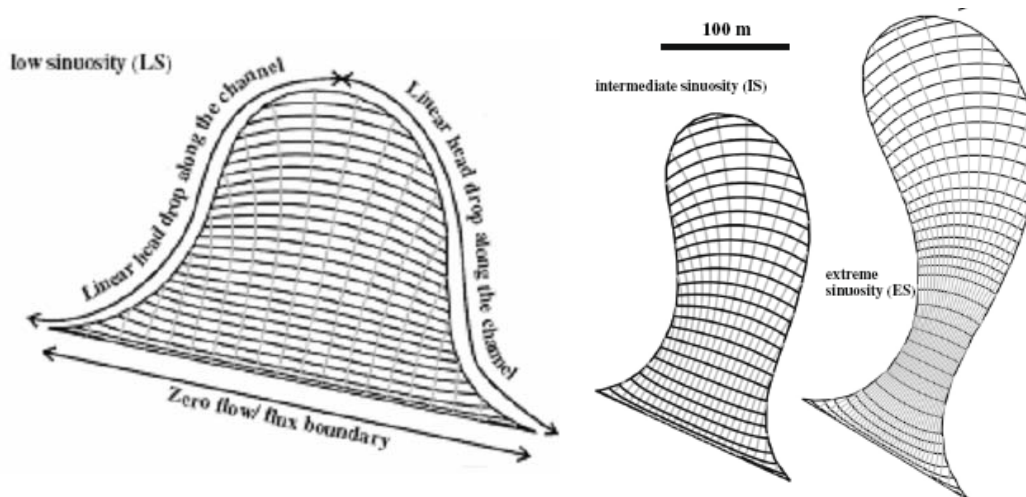

Figure 4.9 Modelled flow patterns across three meander loops of increasing sinuosity (Cardenas, 2008a). The darker lines indicate flow paths and the lighter lines are head contours. The flow in the river is from left to right.

Cardenas (2009) provides a relationship that could be used to estimate flow through point bars for the simple case of sinusoidal rivers where groundwater flow is parallel to the valley axis.

4.4.9 Flood Plain Inundation

If river levels rise rapidly enough, over-topping will occur and water will spread across the river flood plain (Figure 4.10a). This may cause recharge of the surrounding deposits, a process giving rise to the phenomenon of 'bank storage' (Figure 4.10b; Winter et al., 1998). However, often the precipitation that causes river level rise occurs regionally, and the flood plain will therefore also receive water from direct precipitation, tributary stream overflows, and from rising groundwater levels (Figure 4.10c). As river stage declines, groundwater will discharge into the river. Bank failure may also occur at this falling stage (e.g. Rinaldi et al. (2004)), supplying sediment to the river system and possibly changing the river bed permeability.

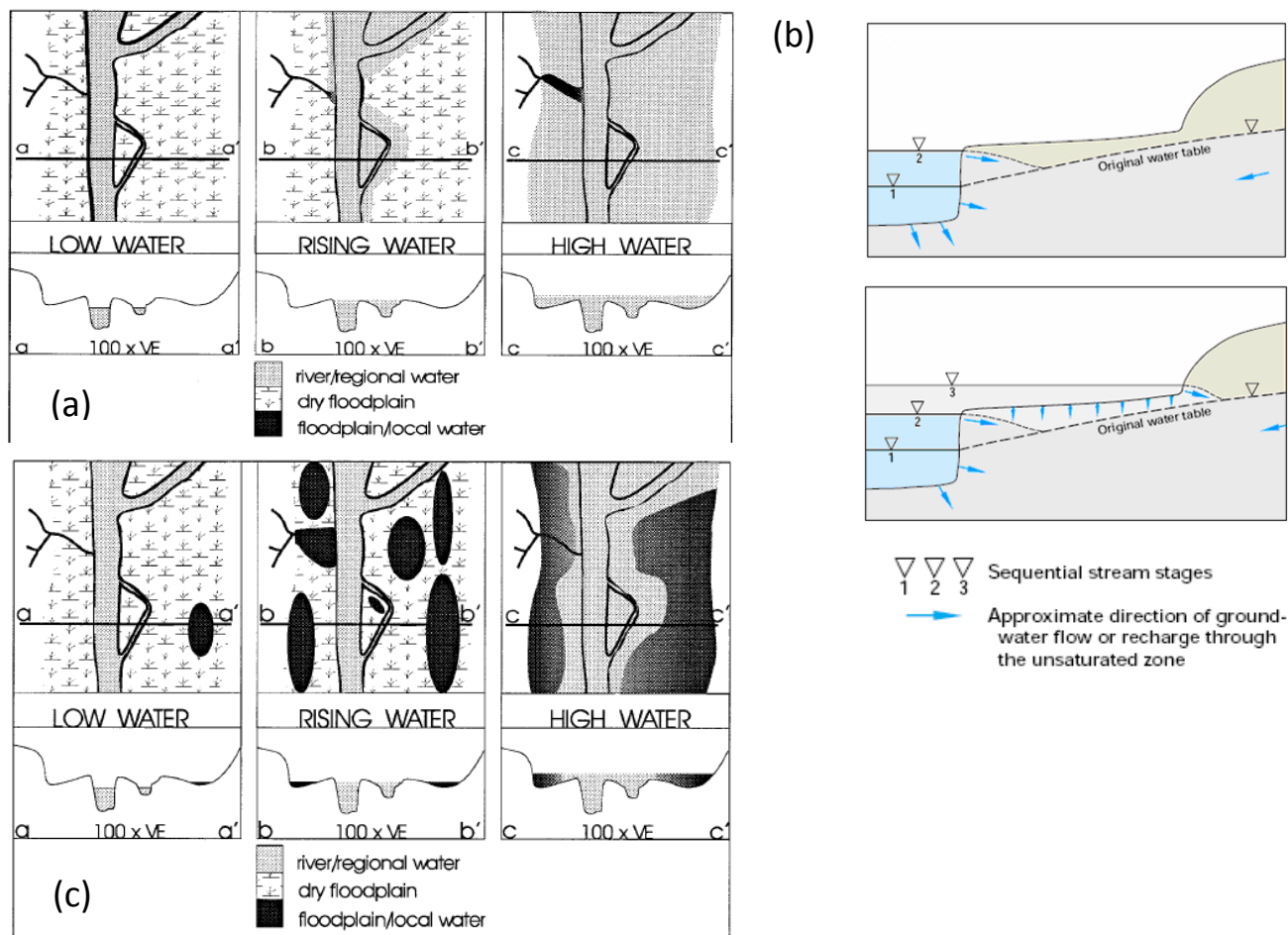

Figure 4.10 (a) river stage rise and inundation of the floodplain, ignoring groundwater (Mertes, 1997). (b) possible impacts on groundwater system – bank storage (Winter et al., 1998). (c) a modified version of (a), including the effects of direct precipitation on the floodplain and rise in groundwater level, both causing local flooding (Mertes, 1997). Which model, or combination of models, is closest to reality will depend on several factors including alluvial deposit groundwater flow system, timing and location of rainfall, and local topography.

4.4.10 Effects of Nearby Pumping Wells

Regional drawdown caused by heavy abstraction can change surface water bodies from being effluent to being influent. In such cases, the surface water body may cease to exist if the hydraulic connection between it and the underlying aquifer is good. At the other extreme, if the hydraulic connection is poor, i.e. the bed of the surface water body is underlain by low permeability materials, the surface water body may become perched. In this situation, the surface water may be little affected other than by the reduction of any baseflow that had been occurring via valley-side over-spilling of the low permeability river-bed deposits (Downing et al., 1974). These are extreme models, and in many cases some limited leakage will occur, usually involving the development of an intervening unsaturated zone. In such cases, the possibility of 'unstable' unsaturated zone flow occurs (Section 4.4.3), and although identification of such flows in the field is relatively rare, if it is occurring it will affect the magnitude of the flow and significantly increase its velocity. As more flow occurs into the aquifer, clogging processes may become important, and some degree of self-sealing may occur. Prediction of flows where an intervening unsaturated zone has developed is difficult, and an area where research could be beneficial.

Another common problem is the prediction of the effects of a single well on a nearby river, either in the case where an assessment of the impact of a well on river flows is required, or in the case where 'river infiltration' is being purposely induced. Much research has been undertaken on this issue, though again almost all of it concentrates on non-perched systems. The 'base case' to which most work refers, and which is still used in practice in many parts of the world, is that analyzed by Theis (1941) (see Miller et al. (2007) for a convenient summary of details). This base case comprises a homogeneous system with fully penetrating well and (straight) river, no recharge, no initial groundwater flow, and constant river water level. Theis's analysis was re-cast in a more convenient form by Glover and Balmer (1954), and in this form is often referred to as 'the Glover equation'. In this simplified system, initially the effect of the river is not seen by the well, but as time of pumping increases, the radius of influence of the well reaches the river and water is drawn into the aquifer. Figure 4.11a shows the flow pattern around the well once flow is induced into the aquifer, and Figure 4.11b the contribution to the well discharge from the river as a function of (dimensionless) time.

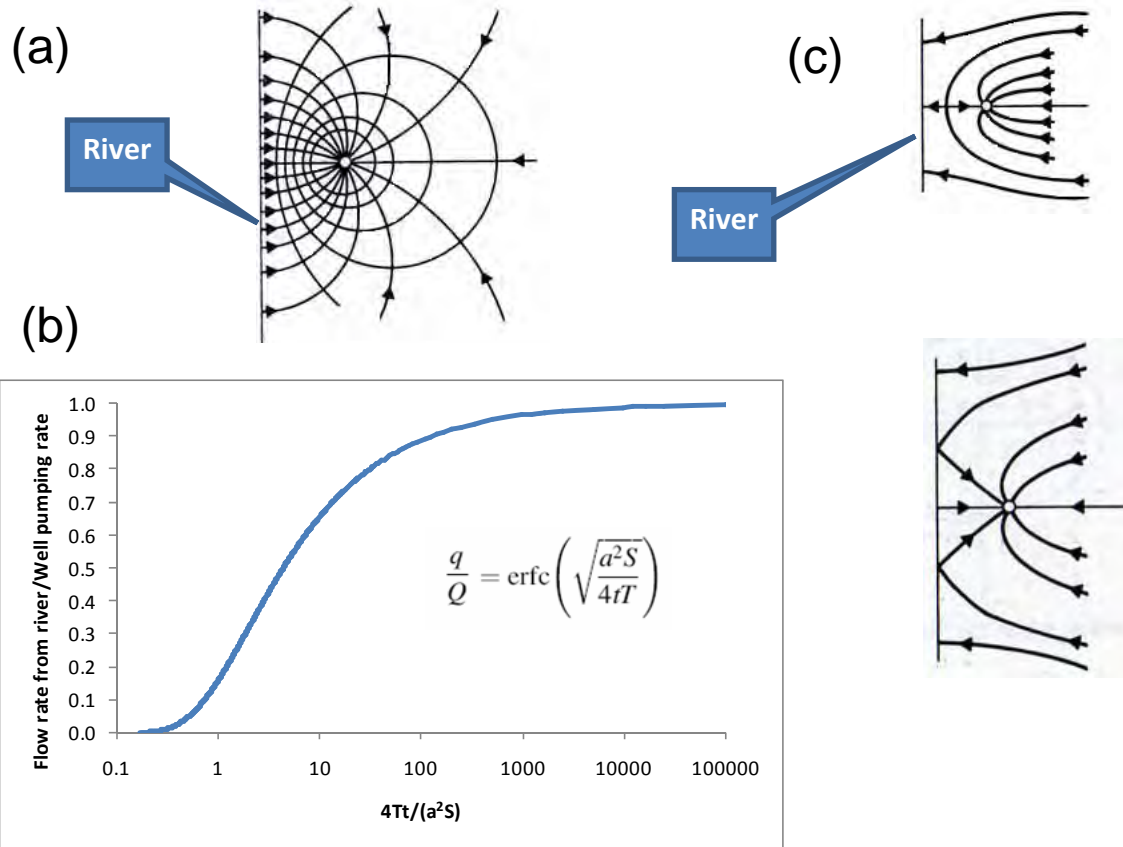

Figure 4.11 (a) schematic diagram of the flow system in the vicinity of a well adjacent to a river with no regional groundwater flow (Raudkivi and Callander, 1976). (b) the increase with (dimensionless) time of flow from a river (q) as a proportion of well abstraction rate (Q) for a river in perfect hydraulic continuity with an aquifer with a horizontal water table (i.e. no regional groundwater flow)(Butler et al., 2001)[a = distance from well to river measured perpendicular to the river; S = aquifer storage coefficient; T = aquifer transmissivity; t = time]. (c) flow in the vicinity of an abstracting well close to an effluent river: for relatively low pumping rates (or short time since pumping commenced) (top) where the well reduces the baseflow to the river but river water is not entering the aquifer; for higher pumping rates (or longer times since pumping commenced) where the abstraction has reversed the hydraulic gradient and water is flowing from the river into the aquifer (bottom) (Raudkivi and Callander, 1976).

In real systems, flow often occurs towards the river before a well starts pumping. In this case, the river flow is affected before flow directions are reversed by reduction of baseflow caused by the reduction in head gradient towards the river [Figure 4.11 (c)]. Downing et al. (1974) analyzed this problem using the simple aquifer/river model shown in Figure 4.12a. They reported their results in terms of 'net gain', defined as

$$NG = [Well\ discharge - Reduction\ in\ flow\ to\ river]/Well\ discharge$$

Figure 4.12 shows examples of the results they obtained for constant and intermittent pumping rates for aquifers with different ARTs (see Section 4.3.3). For aquifers with slow response times (low ARTs) (low transmissivity, high storage coefficient aquifers, e.g. UK Permo-Triassic Sandstones), higher NG values are obtained for any given time, i.e. the river is less affected. Figure 4.13a shows predictions of the relative sizes

of each pumped water flow component as a function of time since pumping began (Chen, 2003). In the case shown, a relatively large amount of water is derived from diversion of baseflow rather than from infiltration of river water. The effects of pumping, not surprisingly, will continue after pumping ceases as shown in Figure 4.13b.

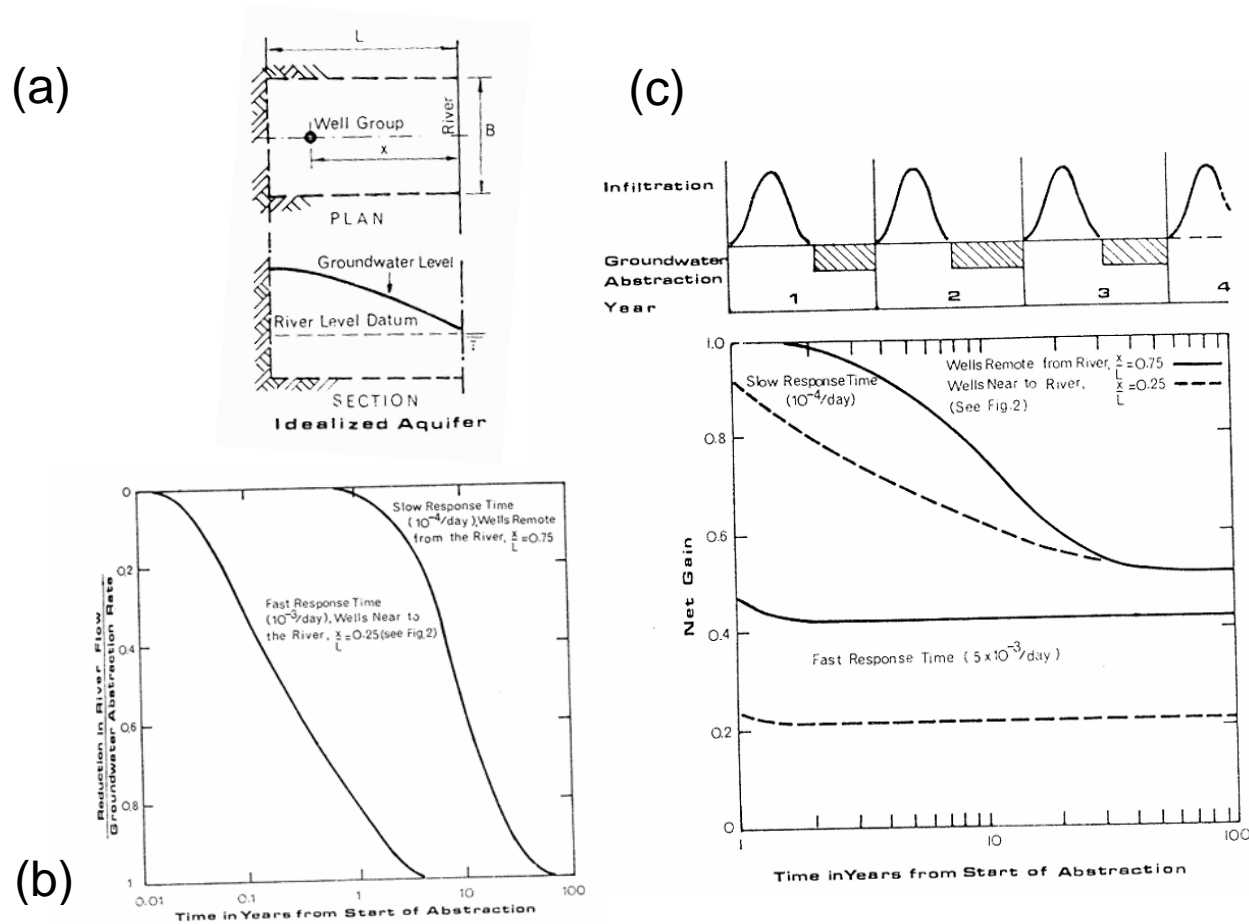

Figure 4.12 The effects of abstraction on a river (Downing et al., 1974). (a) numerical model boundary conditions. (b) the fall in net gain as a function of time for a fast response time aquifer and a slow response time aquifer. (c) the change in net gain as a function of time for fast and slow response time aquifers for seasonal recharge and pumping.

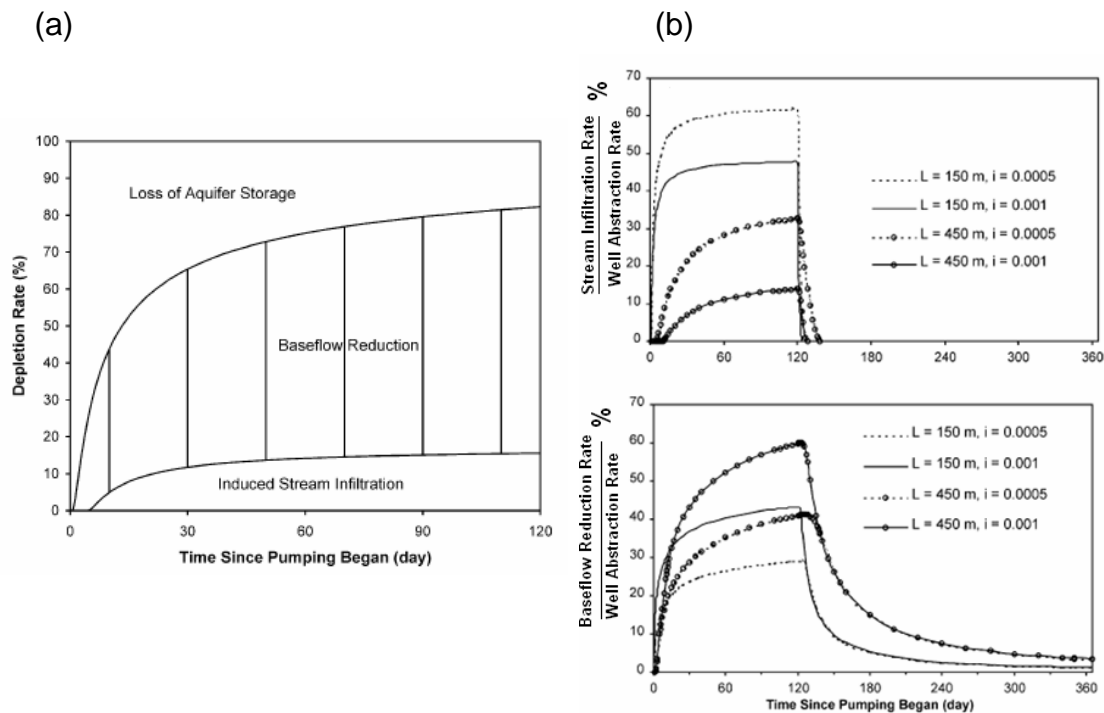

Figure 4.13 (a) a particular example of how the sources of water at an abstraction well near a stream change as a function of time since pumping began as calculated by Chen (2003): note that the proportions will change with system parameter values. (b) the variation in stream infiltration rate (top) and reduction in baseflow rate (bottom) during pumping and after pumping ceases for a well located at distance L from a stream in a groundwater system with an hydraulic gradient of i , as calculated for a particular example by Chen (2003). Pumping stops at 120 days.

A number of other researchers have investigated the effects of various of the assumptions inherent in the 'Glover equation' approach, including partial penetration of the river, finite river width, leaky aquifer, low conductivity of the river bed sediments, a linear barrier boundary parallel to the river, wedge-shaped aquifers (such as a well near the junction of two rivers), and horizontal wells ('galleries'; Butler et al., 2001; Hunt, 2003; Yeh et al., 2008; Wang and Zhang, 2007; Miller et al., 2007). There has been some work on the effects of permeability heterogeneity (Chen et al., 2008), and much local experience has been accumulated for locations where there are active river infiltration schemes (such as the Rhine; Schubert, 2002)]. In addition, though not explicitly in the context of well abstraction, the effects of changes in groundwater discharge on more local, bedform-scale flows have been investigated, for example, by Cardenas and Wilson (2007a)(see Figure 4.15 below).

4.5 Sub-Reach Scale Flow

4.5.1 Introduction

As in the case of pool-riffle-step sequences, smaller scale bedforms also induce downflow, upflow, inflow, and outflow. These smaller-scale bedforms include anti-dunes, dunes, ripples, and obstacles (Chapter 3). The head gradients across these small-scale bedforms and obstacles can be induced by the fall in river heads downstream, but head gradients also arise from the juxtaposition of the generally turbulent surface water flows and the slower laminar flows in the sediment. Variations

at this scale are potentially important for: any pollutant attenuation the sediments may offer; ecosystem support; and design of sampling and monitoring systems.

4.5.2 The Effects of Bedform Structures on Flow

Bedforms such as dunes affect surface water flows such that the pressures along the sediment interface are not constant, i.e. pressure gradients are set up through the sediments. This is a different mechanism to that associated with flows through riffle-pool sequences and meanders described above where the head gradients in the sediments are formed by the fall in river level downstream. The resulting subsurface flows induced by flow over small-scale river-bed irregularities is termed 'pumping' by some researchers (Wörman et al., 2002).

Flows through small-scale bedforms have been investigated by both numerical modelling and field measurement. Figure 4.14 shows the basic flow patterns in a unit wave-form, including in the presence of groundwater upflow from depth (Figure 4.14b): water enters the sediment at the stoss (upflow) side of the structure, and exits through the crest and lee. The flow is such that there is both upstream circulation and downstream circulation within the sediment, unlike riffle-pool sequences. The depth of penetration depends on several factors, but Boano et al (2008) estimate that in homogeneous isotropic sediments the maximum penetration is around 70% of the bedform wavelength for laminar flow in both sediments and river. Cardenas and Wilson (2007b), using a turbulent representation of surface water flows over dune-like structures (i.e. as in Figure 4.14b) to calculate the driving heads at the upper surface of the sediment, found penetration of the surface water to be almost independent of Reynold's number (i.e. of degree of turbulence) above the onset of turbulence, with penetration depths of between 60 and 80% of bedform wavelengths. The geometry of the flow system is similar irrespective of the symmetry and steepness of the dunes. Although the geometry of the exchange zone is independent of Reynold's number, the flux through the zone is strongly dependent upon it. Cardenas and Wilson (2007b) present simple relationships, based on geometry and stream flow velocity, from which penetration of the flows into the subsurface and fluxes can be predicted for the geometries they have investigated.

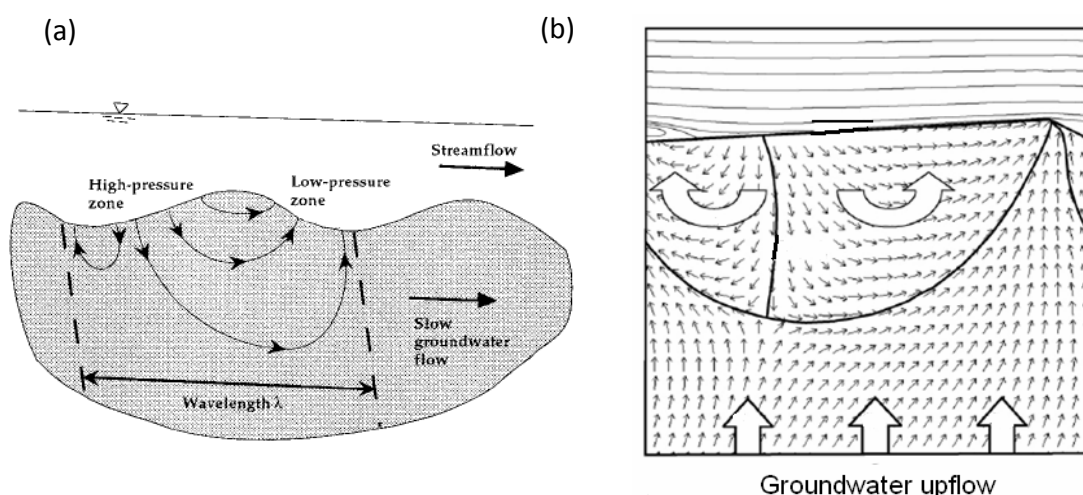

Figure 4.14 Two representations of flow through a unit bedform (e.g. a dune). (a) schematic representation from Wörman et al. (2002). (b) numerical model results from a turbulent surface water / laminar groundwater model from Cardenas and Wilson (2007a); note the eddy in the lee of the dune crest. Wavelength around 1m.

When deep groundwater discharges into a river channel, the depth of circulation of the surface exchange fluxes is reduced. Figure 4.15 shows numerical model results obtained by Cardenas and Wilson (2006) indicating how upflow reduces the depth of penetration of the surface water. Figure 4.16 shows model results produced by Cardenas and Wilson (2007a) for the case where groundwater flow across the bottom boundary is held constant. It was found that, in contrast to the case for no upflow, the size of the penetrated zone increases as river discharge (Reynold's Number) increases. As river flows become larger (far right case (f)), the flow system increasingly approximates the case where there is no deep groundwater discharge: at this point the groundwater discharge is limited to a very small zone close to the crest (better seen on Figure 4.14b). For the surface water to enter the sediment, lateral head gradients must be at least as large as vertical head gradients. Figure 4.16 also includes influent conditions.

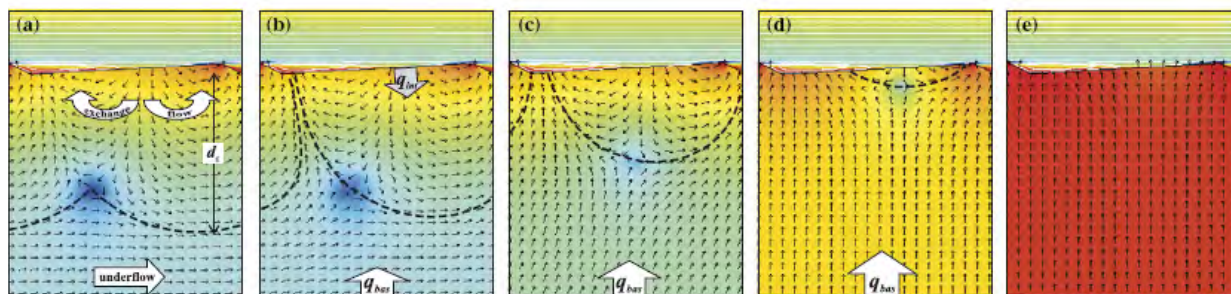

Figure 4.15 The effect of upflow from an underlying aquifer on bedform-induced flows as modelled by Cardenas and Wilson (2006). Assumes laminar flow in stream.

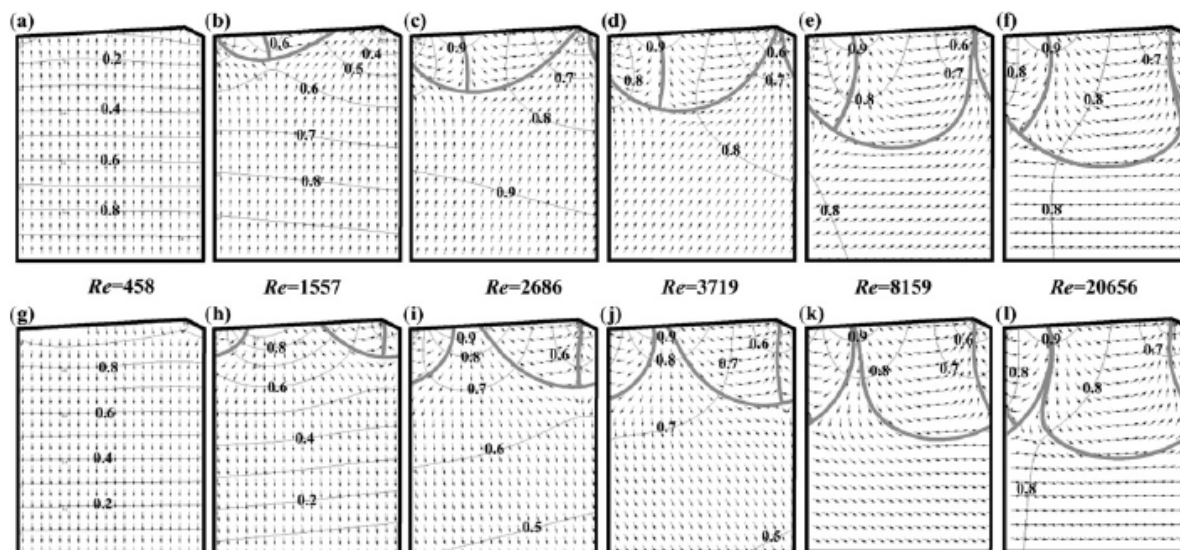

Figure 4.16 Modelled flow fields below bedforms for the case of effluent flow (top row) and influent flow (bottom row) by Cardenas and Wilson (2007a): surface water flow turbulent, with Reynolds' Numbers increasing towards the right as indicated. Contours are of pressures normalised as $p' = (p - p_{min}) / (p_{max} - p_{min})$. Arrows indicate flow directions, but not magnitudes. Solid lines indicate boundaries of the penetration of surface water. Effluent/influent groundwater flux/permeability is approximately 0.1, and bedforms are 1 metre across and have a 0.05 m crest height. No vertical exaggeration.

If the sediment grain size is large, other turbulent effects begin to become significant. Packman et al. (2004) and others have investigated exchange flows with gravel substrates using laboratory flumes. Irrespective of the presence of bedforms, they showed turbulent momentum transfer across the sediment surface to be significant. Turbulent momentum transfer occurs where turbulent flow above the surface/sediment interface is so well developed that the lateral component of the water velocity at the sediment surface becomes significant and this 'slip' velocity induces non-Darcian flow, decreasing exponentially with depth, in the sediment. Packman et al. (2004) also showed that for plane beds, turbulence, probably induced by the grain-scale roughness of the sediment surface, resulted in variations in head at the boundary that induced advection through the substrate, despite the absence of bedform topography. It appeared that these processes were prevalent in the upper ~5 cm of the gravel bed investigated, equivalent to a depth of about 5-10 grain diameters, though flow through preferential pathways was also observed deeper in the sediment. Though it proved impossible to separate the effects of the advective and momentum transfer processes quantitatively, the exchange flux induced was found to be directly related to the square of the Reynold's number based on the characteristic grain size of the sediment. Vollmer et al. (2002) present laboratory data indicating that surface water level fluctuations of periods of a second or more also increase turbulent exchange.

Consideration of the third dimension and permeability heterogeneity results in further complications, as shown by Cardenas et al. (2004) who modelled flows in stream sediments of heterogeneous permeability at a channel bend, taking into account head variations brought about by the presence of bedforms and the channel curvature, though not including momentum transfer processes. Figure 4.17 shows typical results for a range of head boundary conditions (axial, transverse, and local bedform): each picture shows the spatial variation in elevation of the base of the exchange zone. Cardenas et al. (2004) conclude that bedform, channel bends, and permeability heterogeneity all have significant effects on the geometry of the zone penetrated by surface flows, on the fluxes, and on the residence times. The relative importance of each of these factors changes significantly depending on the values of the other two factors.

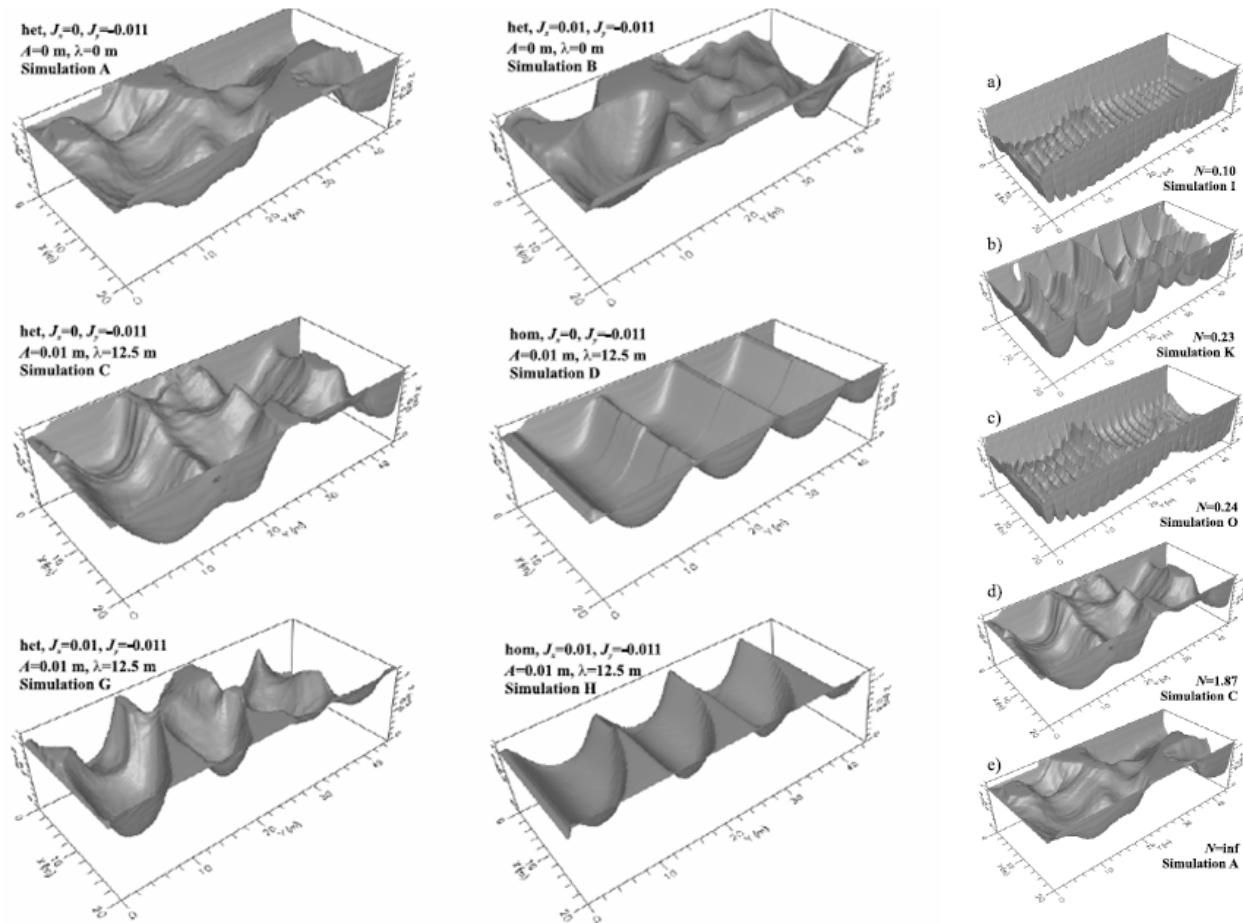

Figure 4.17 Representations of the extent of surface water penetration into river bed deposits as indicated by steady-state modelling by Cardenas et al. (2004). het = heterogeneous permeability in sediments; hom = homogeneous permeability; J_x = hydraulic gradient across stream axis; J_y = hydraulic gradient along axis of stream; A , λ = amplitude and wavelength of sinusoidal head variation applied to stream bed surface. The column of simulation results on the right indicate the effects of an increase in permeability heterogeneity from (a) to (e), with (e) corresponding to Simulation A (top left).

In addition to the sediment bedforms, flow into the substrate can be encouraged by obstacles such as logs (Wondzell and Swanson, 1999), boulders (Figure 4.18a), beaver dams (which can also induce permeability changes according to Genereux et al. (2008)), weirs (Figure 18b), and shopping trolleys (e.g. White, 1990).

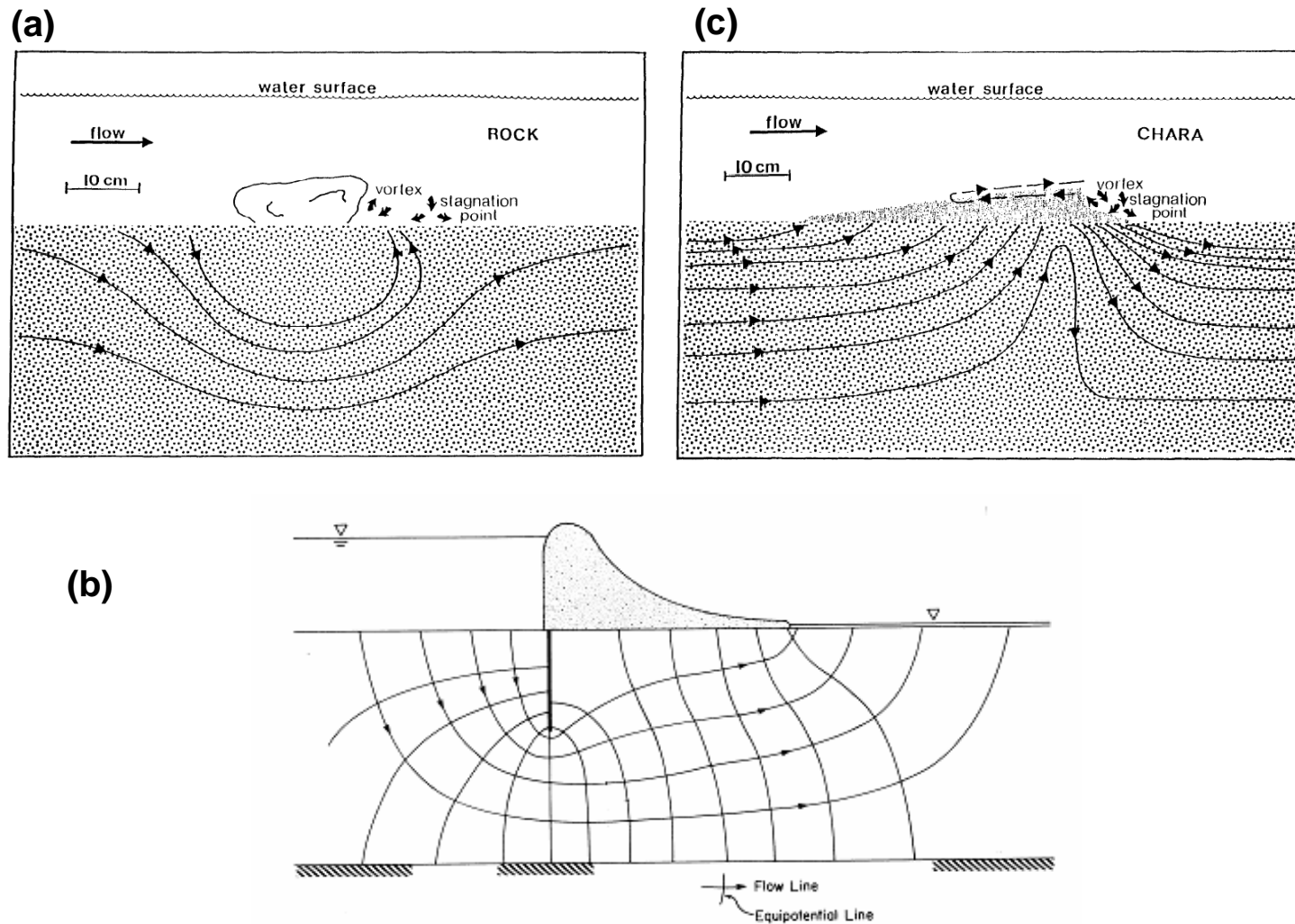

Figure 4.18 Flow in the vicinity of: (a) a boulder on the sediment surface (White, 1990); (b) a weir [modified after Watson and Burnett (1993)]; and (c) *Chara* hummock sand deposits (plant not shown, but would be at up-stream edge of sand deposits) (White, 1990).

4.6 Other Factors

4.6.1 Introduction

This section briefly describes five factors, not always independent, that can be important at different scales: temperature variation; vegetation growth; colmation; bioturbation; and channel geometry evolution.

4.6.2 Temperature Variation

Because the river/aquifer interface is so shallow, temperature fluctuations in the shallowest parts of the SGIZ will be much larger than in many other hydrogeological situations, varying from close to 0 °C to perhaps 20 °C in the UK. A change from 0 to 20 °C will nearly double hydraulic conductivity, and significantly change flows (Constantz et al., 1994; Storey et al., 2003). As temperature increases, some gas may exsolve, thus reducing permeability locally.

4.6.3 Vegetation Growth

Submerged vegetation will also vary significantly seasonally, changing the bottom roughness, and in many cases changing sedimentation processes. Using tracer experiments, Salehin et al. (2003) show that such seasonal changes in vegetation can have a significant effect on exchange flows. For example, trailing strands of *Ranunculus* can often cause slower water flow encouraging the deposition of finer sediment and organic matter resulting in a lens of lower permeability sediment of different chemical nature: Figure 4.18c shows the very similar case of a *Chara* hummock and its effect on flow (White, 1990). When the plant dies back, the sediment is eroded, and hydraulic conditions are again changed. In-channel vegetation, dead and alive, can also result in gas production that in principle can reduce permeability: and overhanging vegetation can also affect in-channel gas production rates by providing shade.

4.6.4 Colmation

Colmation is the clogging of river bed sediments by fine material sedimented out of the water column, filtered out by passage of inflowing river water, or produced by biological processes, including biofilms (Chapter 3). The fine material may come from a wide range of sources, including runoff from adjacent land especially following landuse changes, bank failure, sewage and other discharges, river engineering works, leaf litter, and upstream river bed gravel extraction (Brunke and Gonser, 1997). The clogging material – the ‘colmatage’ – may form on the surface of the sediment, or penetrate it. It will affect ecological systems, and reduce permeability (Brunke and Gonser, 1997). It occurs especially when flows are low, either because of low total discharge or locally in a zone of restricted flow, and when flow is induced through a river bed either because of a regionally low water table or because of near-river pumping (e.g. Schubert, 2002). Rehg et al. (2005) concluded from laboratory experiments that the effect of the addition of fines to a river strongly depends on flow and bed load sediment transport, and Schubert (2002) concludes from field observations that the permeability of the clogged parts of a river bed vary significantly with flow conditions. If flow direction changes from influent to effluent there is a possibility of flow-direction dependent permeability.

4.6.5 Bioturbation

Though plants can cause bioturbation, if only by leaving root holes, it is usually animals

that are most active in disturbing the substrate, altering or destroying the sedimentary structures present. In general it would be expected that permeability anisotropy would be reduced by this process and moderate the effects of colmation, provided that the organisms are able to tolerate the latter. In some cases permeability may be increased by burrowing. Organisms can also create a 'bioroughness' (Huettel and Gust, 1992) that has an effect on pressure distributions and therefore movement of solutes into stream sediments (compare with Section 4.3.2).

4.6.5 Channel Geometry Evolution

River systems are dynamic (Chapter 3) and their geometries continually change as a result of channel avulsion on the large scale, bank failure on reach scale, and local erosion or deposition on the sub-reach scale. For example, Figure 4.9 shows the development of a meander loop through time at intervals of about a century. Such slow movement may not be of importance, but in other cases, both at smaller (bank erosion) and at larger (braided river avulsion) scales, changes may markedly alter flow. At the extreme case, the geometry change may be such that the flow system is suddenly 'reset' (e.g. Wondzell and Swanson (1999)). Packman and Brooks (2001) have examined, in the laboratory and by modelling, the case of migrating bedforms and their accompanying 'turnover' exchange. They found, amongst other things, that at high bedform migration rates the penetration front of the surface water became approximately horizontal indicating that the usual variations due to the advective 'pumping' processes were averaged out.

4.7 River Bed Sediment Permeability

The permeability of stream bed sediments depends very considerably on the source material, the flow conditions, and a range of other factors including many of those mentioned in Section 4.6. Because of the multiplicity of contributing factors, it is not possible to generalise on absolute values with any accuracy. However, the data compiled by Calver (2001) may provide a guide, as may the estimation approach of Booker et al. (2006).

Stream bed permeability is often very variable in space and time. In one recent study, Genereux et al. (2008) undertook 487 field measurements of permeability of the bed of a stream in North Carolina, USA, over a period of a year. For a reach of 263 m in length, they found a mean permeability of 16 m/d, with a range of 0.01 to 66 m/d. Overall, the permeability was neither normally or log-normally -distributed, but bimodal. There was significant variation over distances of a few metres, with generally higher permeability under the centre of the channel. The permeability distributions varied very significantly over a year as shown in Figure 4.19. Changes in stream bed elevation indicated that erosion was an important factor in causing this variability.

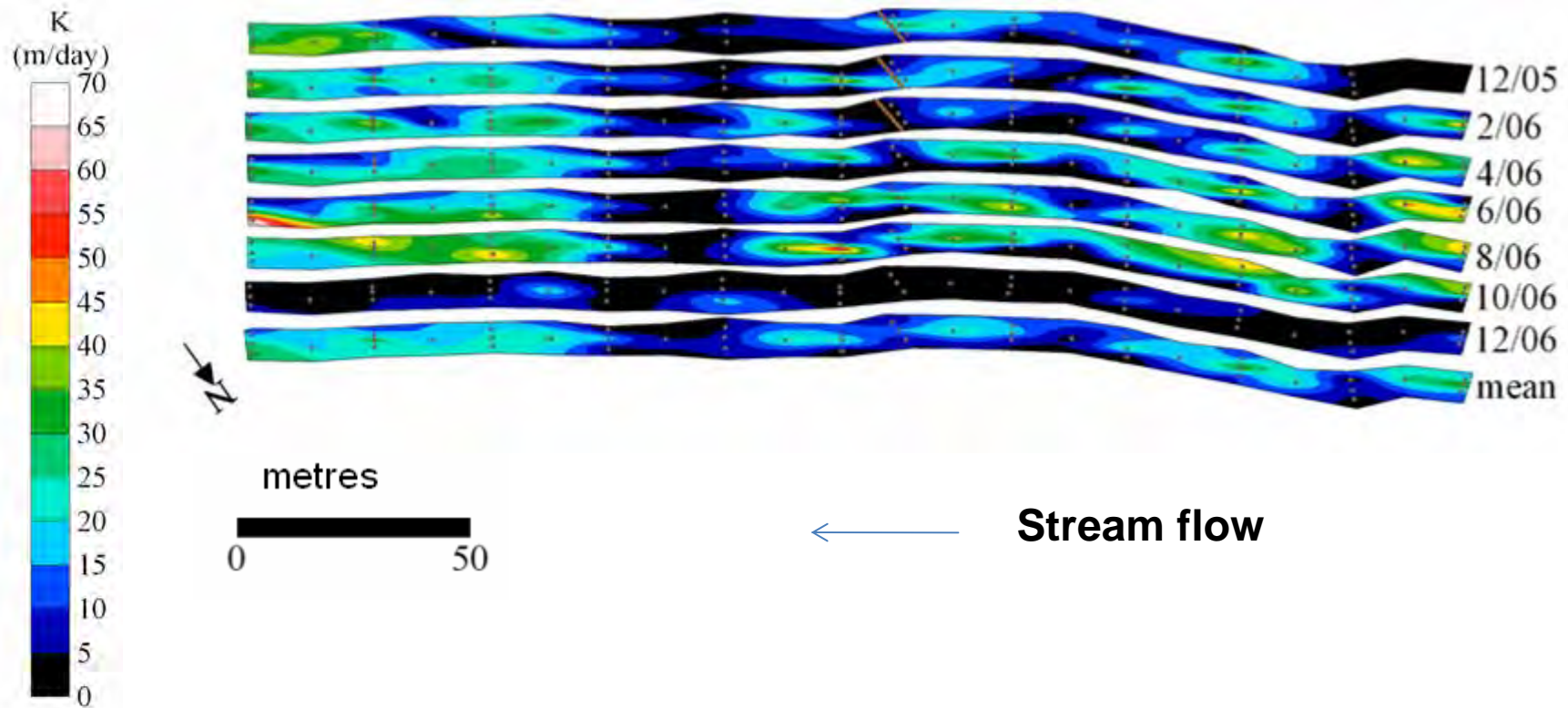

Figure 4.19 The variation in space and time of the permeability (K) of stream bed sediments as measured using a falling head method in a tube inserted 36 cm below the sediment surface along a reach of West Bear Creek, North Carolina, USA (Genereux et al., 2008). Measurements were taken between December 2005 and December 2006. The red line indicates a beaver dam, and the dots indicate measurement points.

4.8 An Overview of the Flow System in the River/Aquifer Interface Zone

It is clear that the flow system in the river/aquifer interface zone is often a fairly complex one, showing a great deal of variability in time as well as in space, especially in coarser more permeable systems. This complexity gives rise to variable fluxes across the interface, as illustrated in the single time snapshots shown in Figure 4.20. Figure 4.21, from a modelling study by Poole et al. (2008) on a river in the USA, indicates how complex the groundwater flow paths can be. Most flow paths, perhaps unsurprisingly, are short in this relatively small, shallow (< few metres thick), high permeability (400 m/d), gravel system (90% < 100m), but some flow paths are much longer (> 1km), resulting, in some cases, in reaches where adjacent discharges are from widely separated recharge locations.

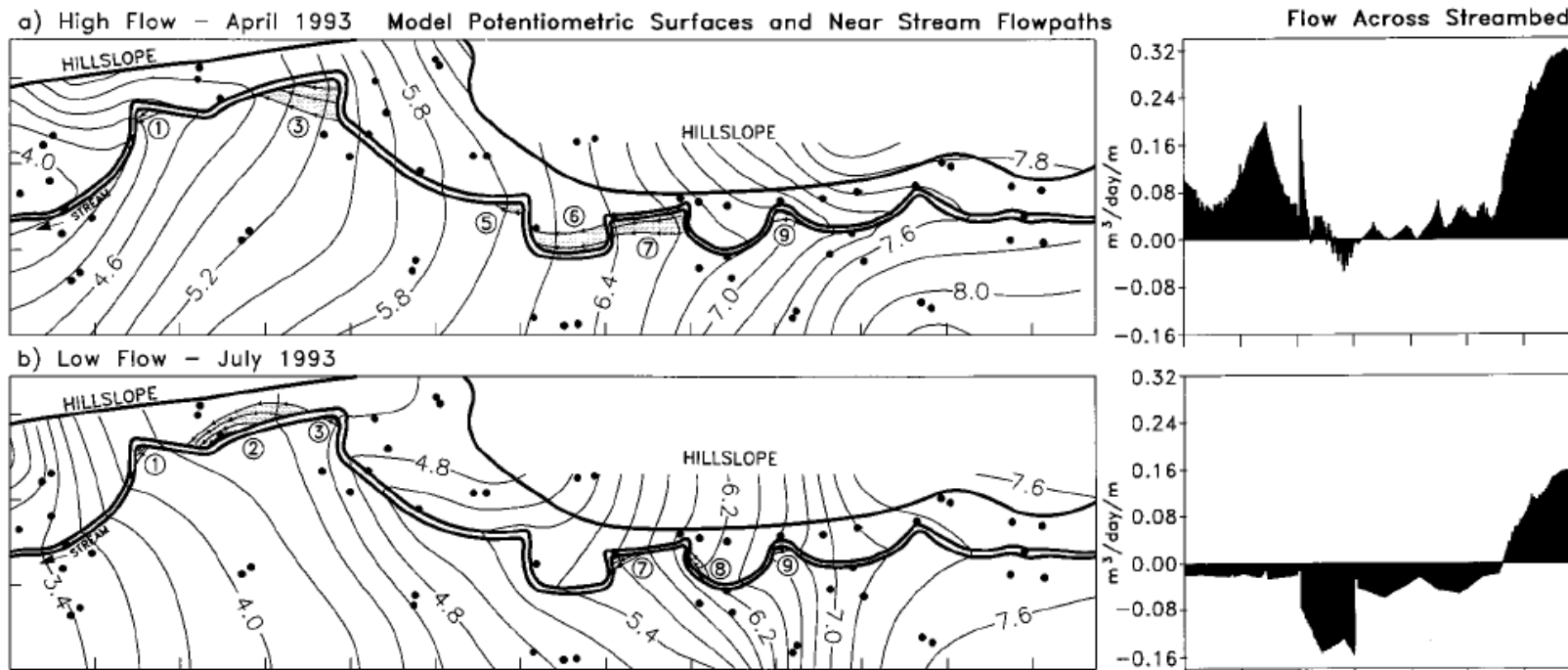

Figure 4.20 Modelled groundwater heads and some near-stream groundwater flow paths for (a) high flow and (b) low flow conditions in Aspen Creek, New Mexico, USA (Wroblicky et al., 1998). Discharges to (>0) and from (<0) the stream bed are shown to the right. Stream flow is from right to left.

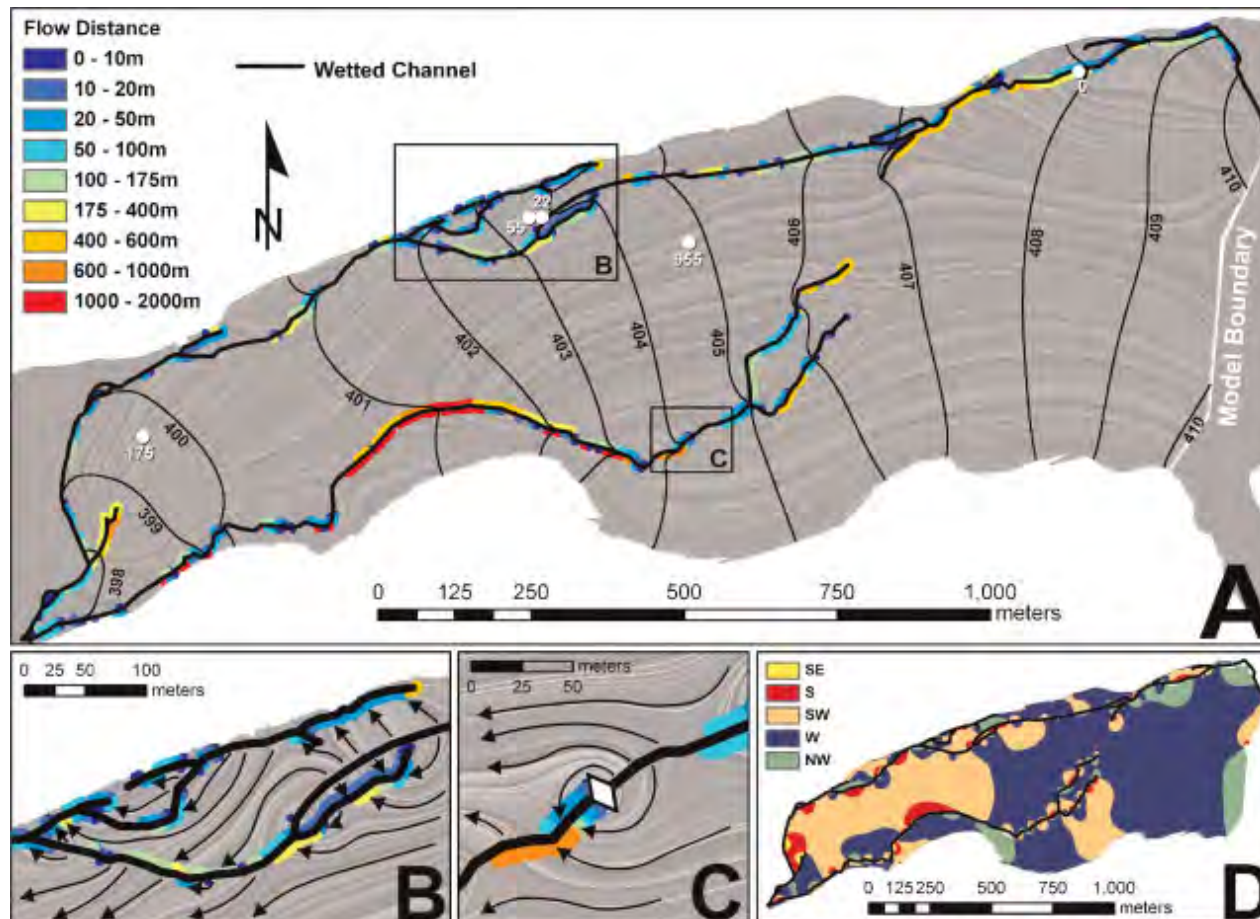

Figure 4.21 Two dimensional modelling results for flows in the vicinity of the Umatilla River, Oregon, USA (Poole et al., 2008) during low flow in 2004. Panel A shows the groundwater flow lines and the groundwater head contours (m); colours along channel reaches indicate the flow path lengths associated with the discharge locations (recharging reaches are left un-ornamented). Panel B shows modelled flows between main and secondary channels. Panel C shows the effect of a beaver dam (white diamond) on local flows. Panel D maps out the flow directions across the alluvial plain aquifer.

The basic characteristics that river/aquifer flow systems in general possess include (e.g. Poole et al., 2008):

1. aquifer to river or river to aquifer flow, and often both in close proximity
2. some river water, often because of channel topographic variations or obstructions, passes down into the shallow subsurface, subsequently mostly re-emerging downstream
3. some river water, often again because of channel topographic variations or obstructions, passes out laterally into surrounding deposits, some later to re-join the river downstream
4. total exchange flow is often much greater than net exchange flow
5. because of the nature of the river channel morphology, there is some nesting of flow pathways, just as in regional, 'Tothian' (Toth, 1970), flow (Figure 4.3), and often short pathways are more common than long pathways.

This list best fits non-karst, high permeability systems. In karst systems, flow to and from a river may be very strongly controlled by relatively few fractures. In low permeability systems, on which less research has been undertaken, SGIZ flows may be very limited.

Poole et al. (2008) provide a useful summary of these ideas, termed by them 'hydrologic spiralling', as illustrated in Figure 4.22.

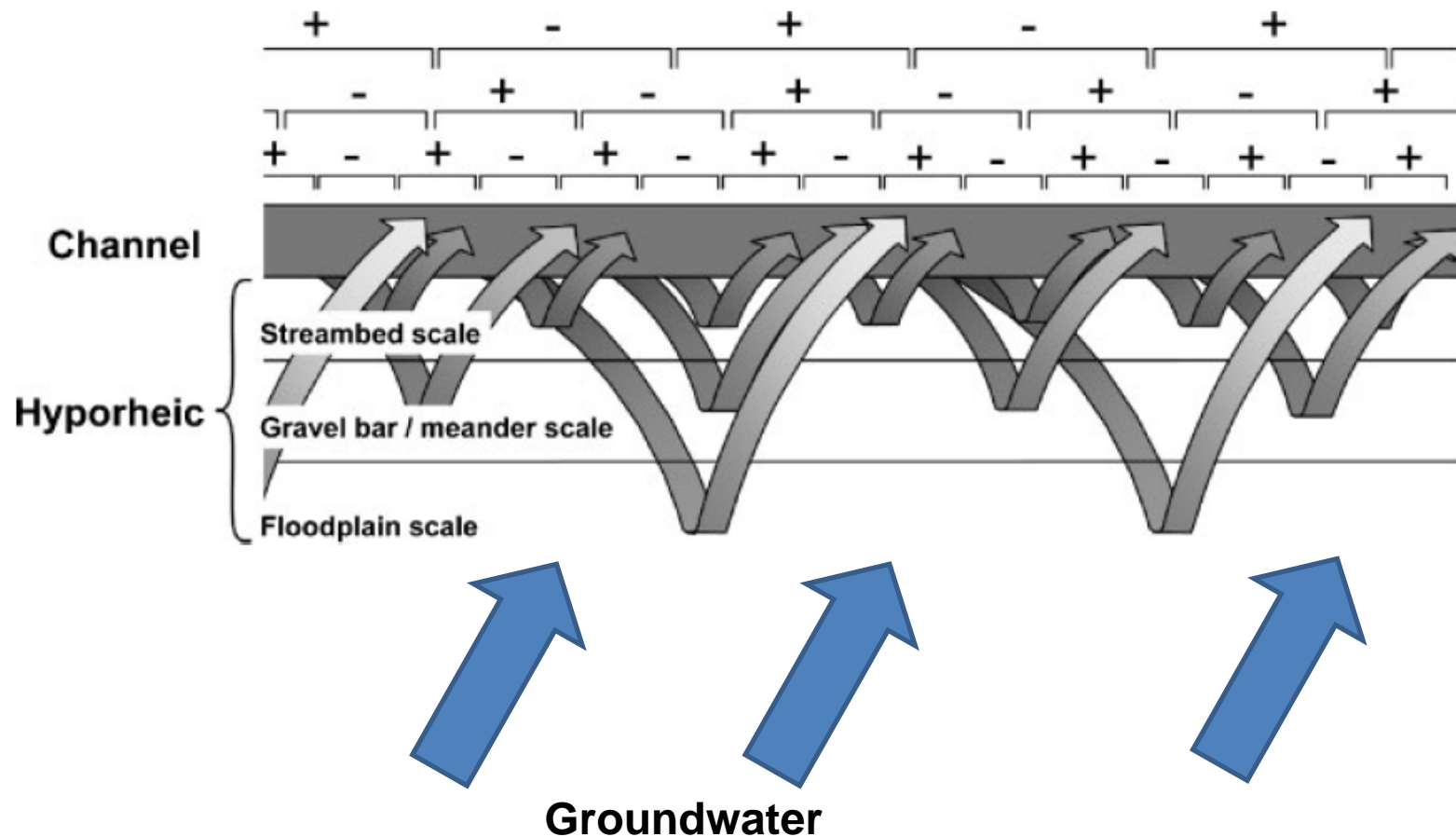

Figure 4.22 A cartoon illustrating the 'hydrologic spiraling' concept of Poole et al. (2008). The figure shows a longitudinal cross-section of a stream system with flows leaving and subsequently re-joining the stream on a variety of space (and time) scales. Changes in arrow shading indicate changes in water temperature and chemistry. Plus and minus signs indicate effluent and influent flow zones associated with each of the nested flow paths. In some cases there will be groundwater discharge (or recharge) also.

4.9 Solute Transport

4.9.1 Solute Transport Through Catchments

River chemistry represents the integration of the concentrations from all the pathways through the catchment, including the subsurface pathways. Examination of catchment time series data for unreacting solutes (Kirchner et al., 2000, 2001) has shown that the concentration fluctuations in streams are strongly damped relative to those in rainfall, except on the longest timescales (greater than 5 years in the case of the Hafren catchment in Wales, for example). The 'white noise' rainfall power spectrum signal is converted by the catchment into a fractal ' $1/f$ noise' power spectrum signal (where f is frequency). It can be shown that this implies that solutes have 'long-tailed' residence-time distributions – the passage of a rainfall concentration peak through the catchment will be 'smeared' out, with rapid initial breakthrough followed by a very long decline. The residence times follow approximately a power function (i.e. $frequency = constant1 \times residence_time^{constant2}$, $constant2 < 0$).

Following this observation, initial modelling investigations suggested that, for relatively simple catchment geometries, the long-tailed solute distributions can be reproduced only if very large dispersion coefficients are used, implying probably unrealistic heterogeneities in hydraulic properties (Kirchner et al., 2001). Subsequent modelling work on nested flow systems (cf. Figure 4.3) in catchments of self-similar ('fractal') topography indicated that solute residence time distributions similar to those seen in the field data can be simulated (Wörman et al., 2007): Cardenas (2008b) goes as far as to claim that the observed residence time distributions are inherent in flow structures from ripple-scale to regional groundwater flow system scale. Although research continues, the important finding is that solute breakthroughs to rivers are strongly tailed.

4.9.2 Solute Transport at the Reach Scale

Numerous in-stream tracer experiments indicate that a 'transient storage' phenomenon occurs during movement of tracers downstream. This can be significant, resulting in delay in transit time along the stream, and tailing of breakthroughs (e.g. Figure 4.23a). Although some of this transient storage may be due to in-channel processes (for example as a result of the presence of in-stream vegetation or eddy pools), much is due to exchange flows (Figure 4.23b)) as already suggested in Section 4.9.1. In an analysis of 53 tracer studies, Runkel (2002) showed that transient storage processes accounted for between 0.1 and 68% of the total reach transit time. The remainder of this subsection summarises the results of modelling studies that have shown what reach-scale processes might give rise to such delays; sub-reach processes, which also affect the observed tracer breakthrough patterns, are considered in Section 4.9.3.

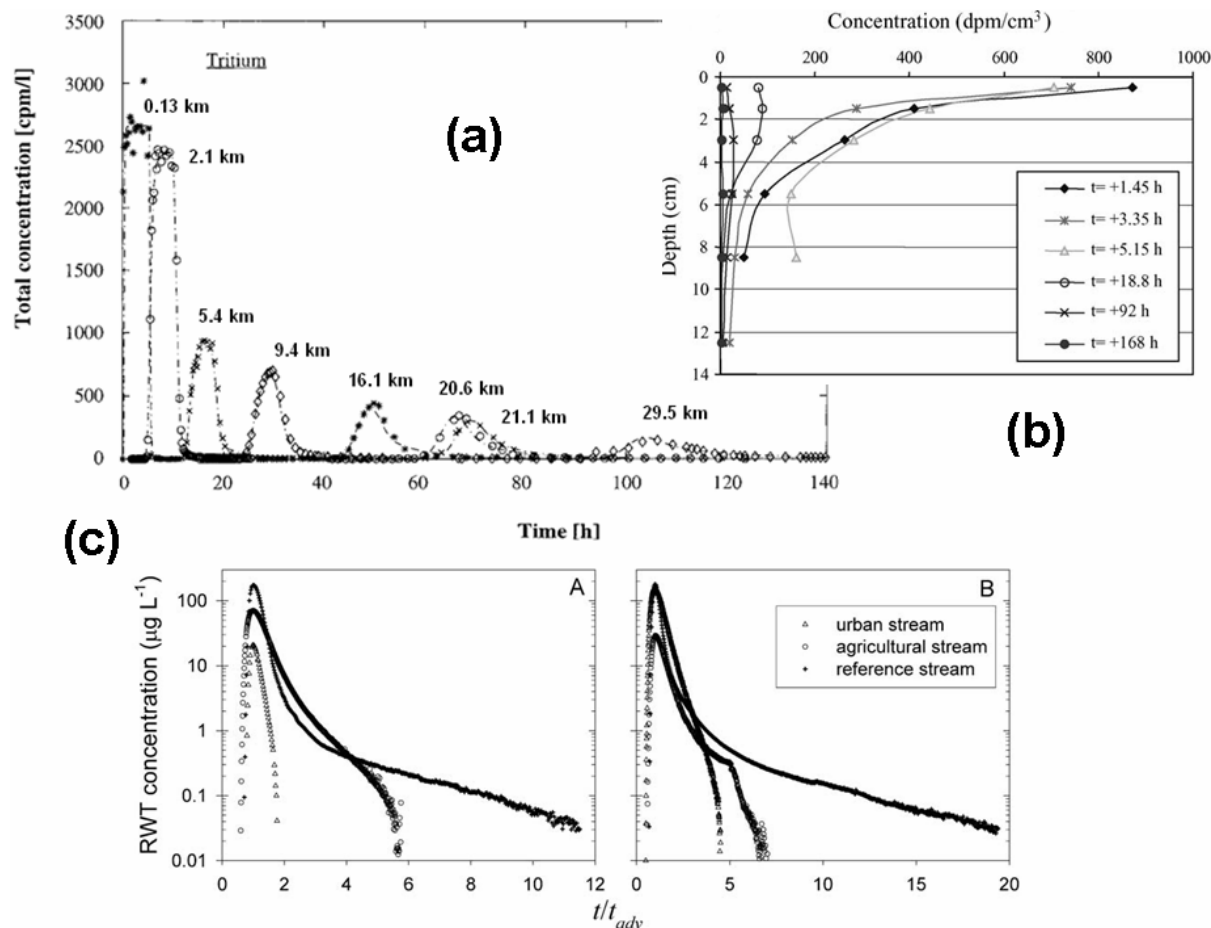

Figure 4.23 Results of in-stream tracer tests. (a) the tracer (tritium) breakthrough in stream waters at eight locations along a 30 km reach in Säva Brook, Sweden (Wörman et al., 2002). (b) concentration profiles in the stream bed sediment at the 0.13 km sampling location of (a) (concentrations in millilitres of 'wet substance')(Jonsson et al., 2003). (c) rhodamine WT tracer breakthrough in stream waters for experiments undertaken in 2003 (left) and 2004 (right) in streams in Jackson Hole, USA; the times have been normalised by dividing by the advective transport time (t_{adv}) (Gooseff et al., 2007).

Cardenas (2008a) has undertaken a modelling study of the breakthrough of solutes across three meander loops of different sinuosity. Figure 4.24 shows the predicted progress of an unreacting solute front. Breakthrough first occurs at the apex of the bend, and then through the neck. There is a wide spread of breakthrough times, with significant breakthrough occurring, not surprisingly, before one pore volume, and full breakthrough not occurring until in excess of six pore volumes – i.e. non-Fickian (Figure 4.25a). This is emphasised by the plots of Figure 4.25b which represent residence time distributions: the peaks approximately mark the time of breakthrough at the meander neck, subsequent to which a power-function relationship can be fitted to the breakthrough time/frequency data.

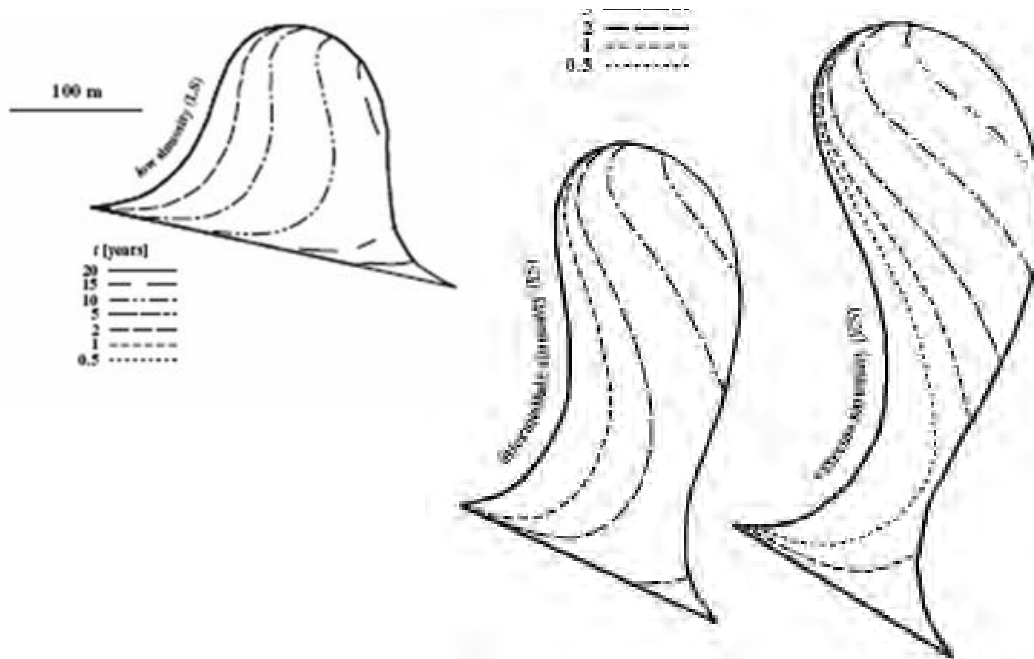

Figure 4.24 Unreacting solute movement fronts through meander loops of different sinuosities as indicated by modelling undertaken by Cardenas (2008a). The corresponding flow nets are given on Figure 9. Permeability is 50 m/d, porosity 0.3, and channel head gradient 0.0001. Longitudinal dispersivity is 0.1 m in all three cases with transverse dispersivity a tenth of this, and the front is indicated by the concentration / initial (i.e. up-stream boundary) concentration contour of 0.9.

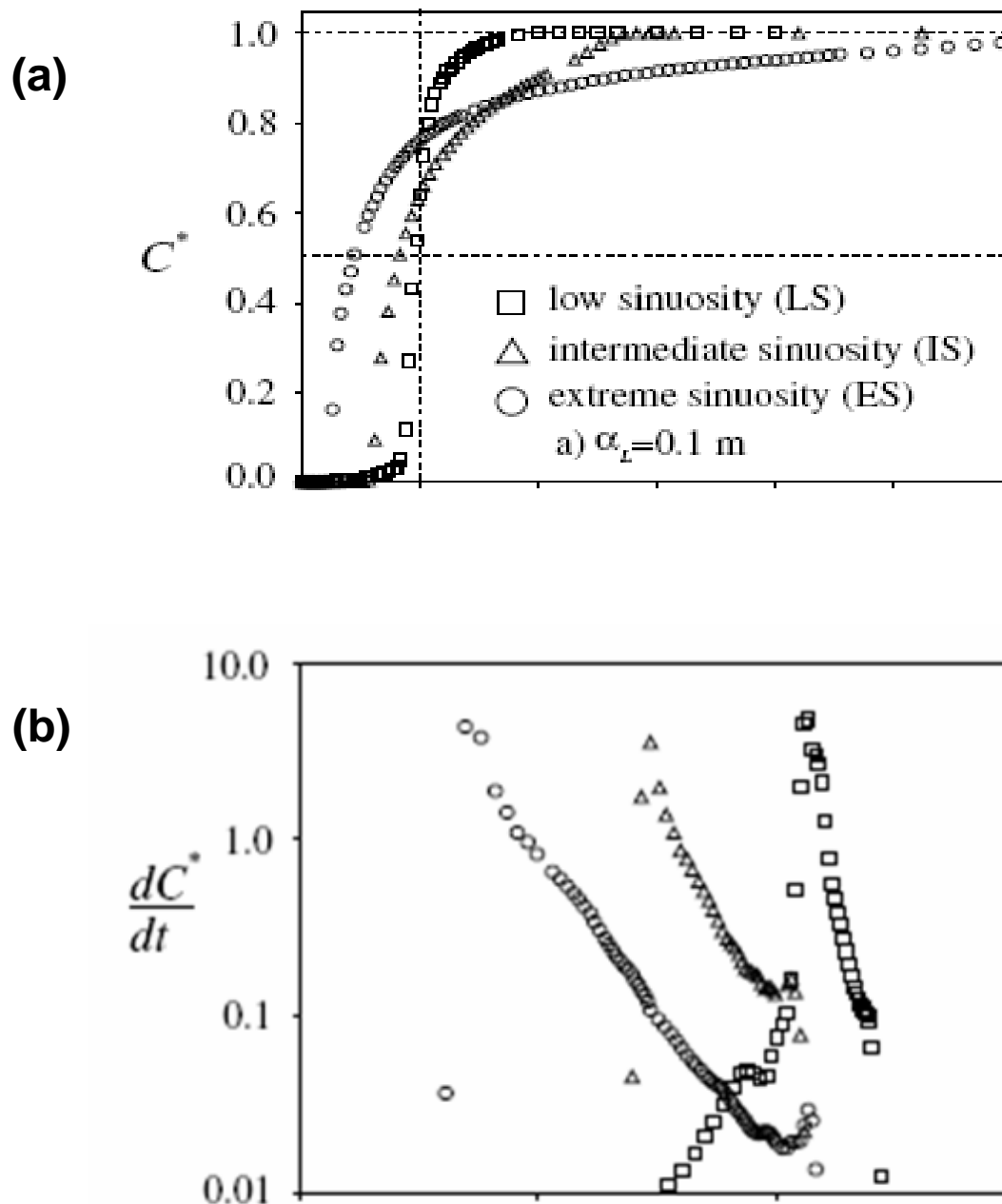

Figure 4.25 Breakthrough curves and residence time distributions for the three modelled meander loops shown in Figure 24 (Cardenas, 2008a). (a) breakthrough curves for the water exiting the downstream side of the meander loops: C^* = concentration / initial (i.e. up-stream boundary) concentration ratio; t^* = dimensionless time (= pore volume) = tV/A where t is time, V is the flux integral along the discharge line, and A is the horizontal area of the meander loop. (b) residence time distribution of solutes in the meander loop: dC^*/dt is a measure of the frequency of occurrence of residence times t .

Modelling investigations by Cardenas et al. (2004) illustrated in Figure 4.17 indicate that residence time distributions in bed sediments of heterogeneous streams are log-normally distributed: this study also showed that log-normal distributions can be produced by permeability heterogeneity alone. Depending on circumstances, permeability heterogeneity can cause an increase or a decrease in mean residence times, reflecting the complex interdependency within the system. Cardenas et al.

(2008) conclude that in the absence of strong permeability heterogeneity and significant in-channel storage, channel/bedform geometry will result in power-law residence time distributions over times from minutes to tens of days.

Figure 4.26 shows results from the study of Storey et al. (2003) (Section 4.4.7) indicating model-estimated groundwater residence times and flow path lengths around a riffle-pool sequence in Ontario. The complexity of the dependence of residence time and flow path length on permeability and head is clear.

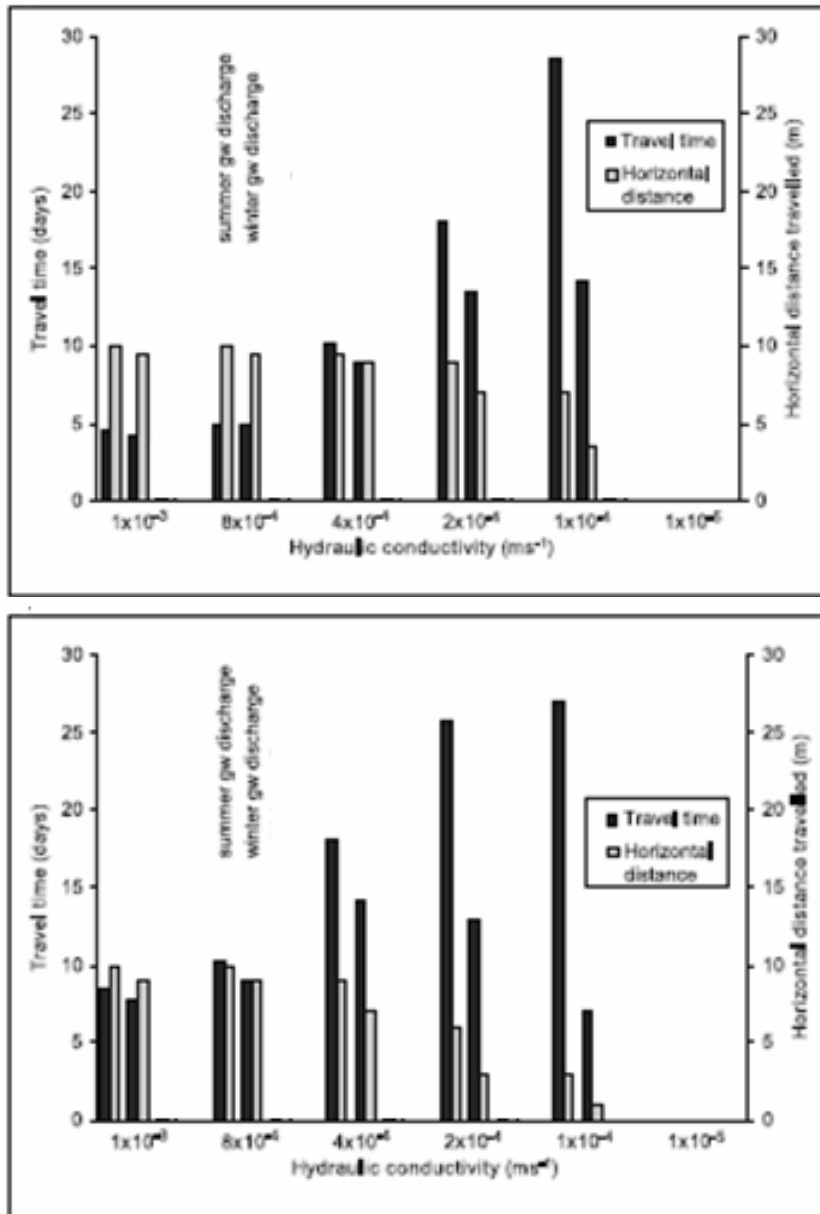

Figure 4.26 Residence times and flow path lengths for flows in the vicinity of a riffle in an effluent gravel-bed stream in Canada as modelled by Storey et al. (2003) (see also Figure 8), showing sensitivity to bed permeability and groundwater discharge (winter = twice that of summer) for (a) head difference across the riffle as in summer and (b) head difference across the riffle as in winter (= half that for summer).

There is even less information available on solute movement from perched rivers into an underlying unsaturated zone than there is for flows in such systems. Unstable unsaturated flow (see Section 4.4.3) may reduce residence times and attenuation of solutes.

4.9.3 Solute Transport at the Sub-Reach Scale

Figure 4.27 shows an example dataset of concentrations against depth for a small river (Tame, English Midlands; Rivett, M.O., pers. comm., 2009). The concentration profiles vary significantly in time and space, and this is very likely to be the case in many other rivers.

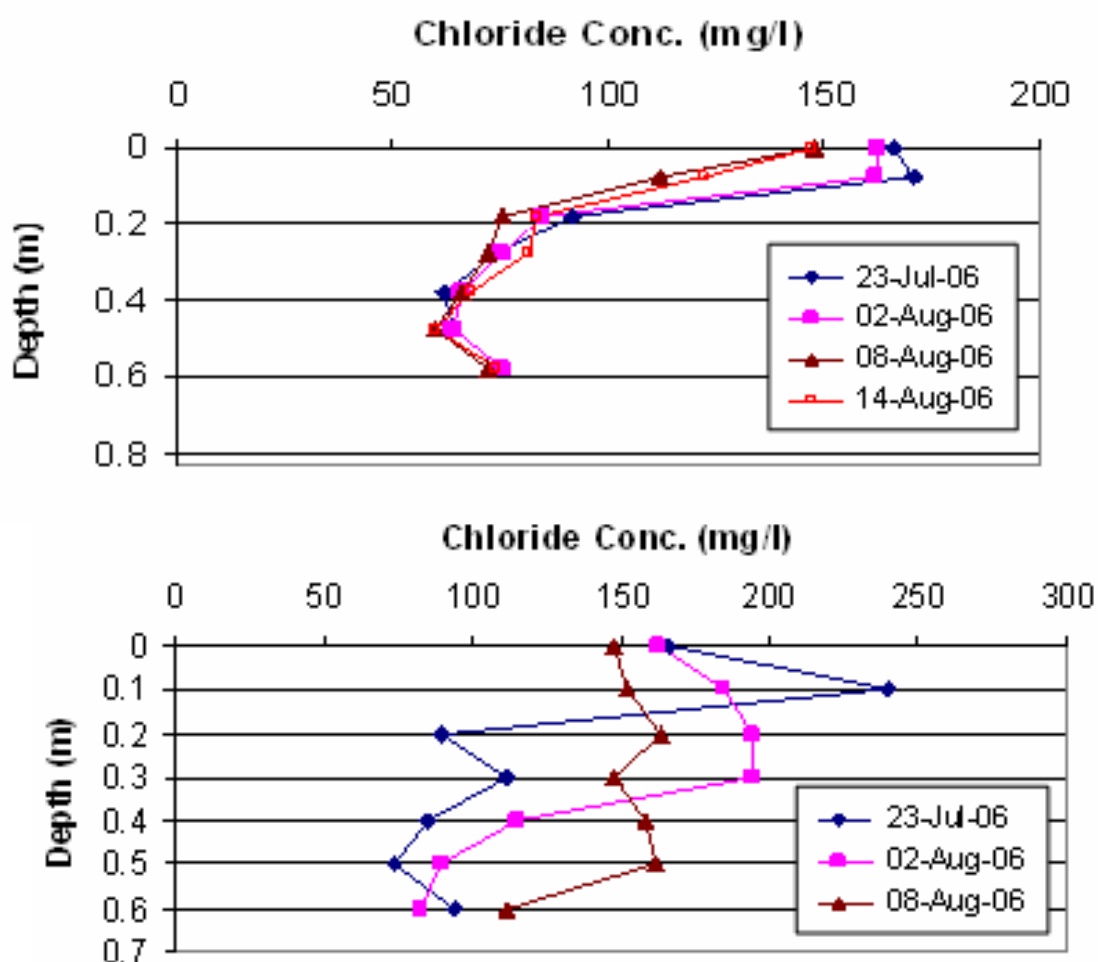

Figure 4.27 Chloride concentration profiles below the River Tame in Birmingham at two sites (M.O.Rivett, pers. comm., 2009).

Elliott and Brooks (1997) showed that, at early times, advection into bedforms can be satisfactorily represented by a diffusive model, a model that implies exponential residence time distributions. However, Cardenas et al. (2008) have explored residence time distributions in further detail, using a numerical model that includes the effects of turbulent surface flow. They found that breakthrough curves and residence time distributions were very similar in style to those for meander systems, with long-tailed breakthrough curves (*i.e.* similar to those in Figure 4.25). For later-times, the residence time distributions can be described by power functions in the numerical experiments undertaken, with intervals from minutes to tens of days. Advection seems to dominate

over dispersion and diffusion. Cardenas et al. (2008) expect that similar results will be found at other scales, as bedforms have similar geometries over a range of scales, as long as the bedforms are sufficiently submerged.

All the results presented above are for relatively permeable sediments – coarse sands and gravels. If the sediment grain size is small, the permeability of the substrate will be low and advective exchanges will be very limited (Ryan and Boufadel, 2006). In this case, diffusion will start to become important for the sediment porewaters, though probably not for the surface water system as the flux rate will be very small.

For larger grain sizes, turbulent transfer of water and solutes across the sediment surface becomes important even in flat stream beds (Section 4.5.2). Packman et al. (2004) suggest that the combined effects of non-Darcian advection and turbulent 'diffusion' due to momentum transfer can be represented using a diffusion formulation, and they provide suggested 'diffusion' coefficients that depend on Reynold's number, grain size, and bedform presence or absence. The turbulence-induced transport in the experiments of Packman et al. (2004) were seen to be prevalent to depths of only 5 to 10 grain diameters, though transport through preferential pathways occurred to greater depths. Ellis et al. (2007) explore the effects on transport of solutes in the River Tame, English Midlands, of various processes, and found turbulent mixing due to pressure transients in the river to be a potentially significant process affecting shallow (decimetre) solute distributions.

The three-dimensionality of all river systems provides more complexity (Section 4.9.2). Good illustrations of the possible local complexity of solute patterns is provided by several of the figures presented above, and also by the numerical experiments of Tonina and Buffington (2007) as shown in Figure 4.28. In addition, such diagrams, and especially Figure 4.16, suggest that groundwater discharge will be through limited volumes of the substrate, and hence most of the total attenuating capacity of the river bed sediments may not be available to the inflowing groundwaters at any one time.

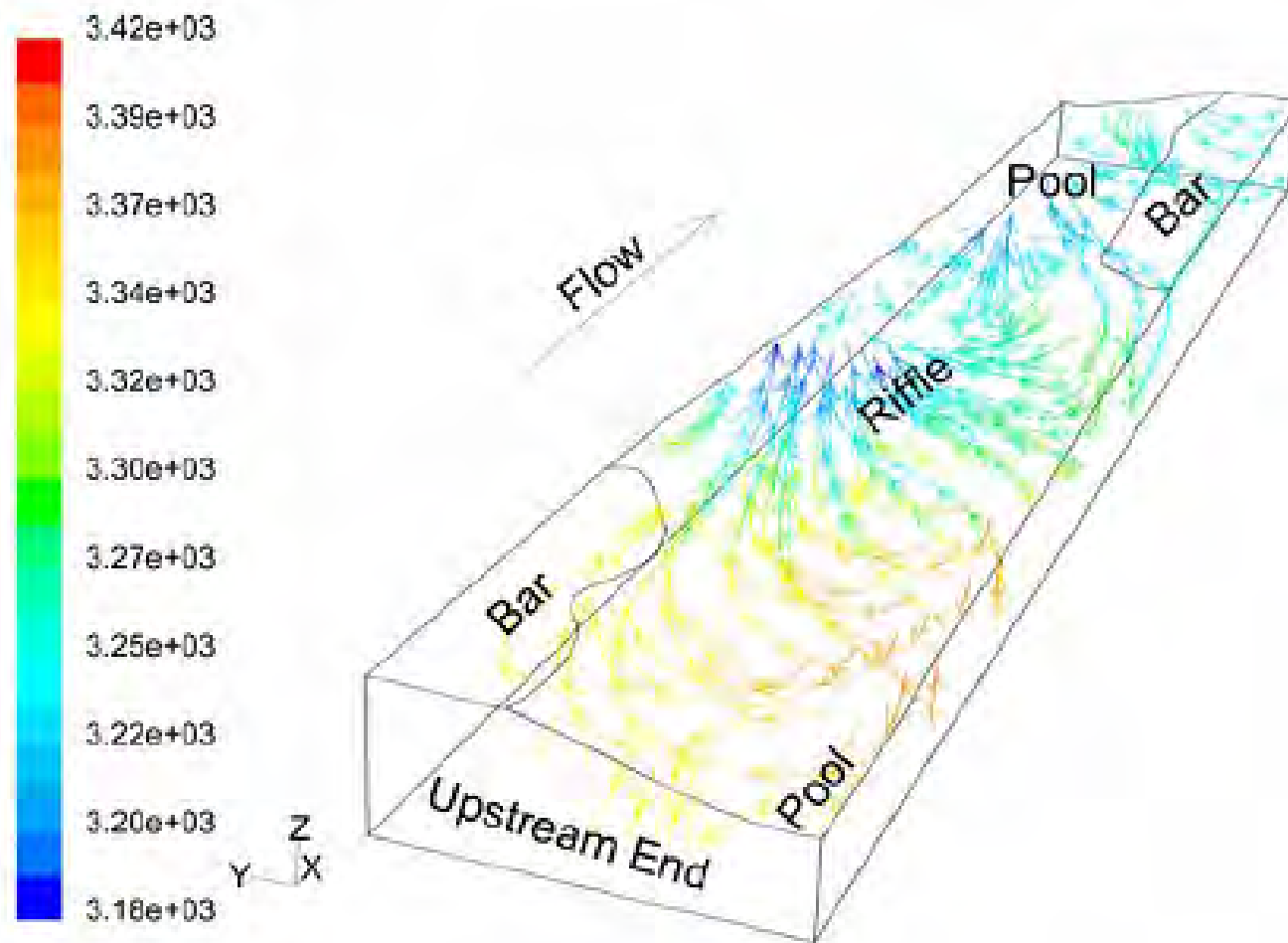

Figure 4.28 The complexity of flow paths through a three-dimensional medium-amplitude bedform as indicated by the modelling of Tonina and Buffington (2007). The pathlines all start at the sediment surface and are coloured according to pressure (Pa).

4.10 Towards Prediction

It is hoped that the ideas and examples described in this chapter will provide sufficient background to enable the construction of conceptual models for particular sites. Such conceptual models are often useful in their own right, for example in planning monitoring investigations. However, conceptual models also form the basis of quantitative modelling, a topic covered in Chapter 9. Although the full complexity of river/groundwater exchange systems is unlikely to be amenable to quantitative prediction in practice, much can be gained from simplified models based on assumptions developed from a sound conceptual understanding.

5 Biogeochemistry and hydroecology of the hyporheic zone

5.1 Summary of key messages

1. The hyporheic zone (HZ) is an important habitat and refugia for a range of organisms, and an area of biogeochemical cycling of nutrients and contaminants.
2. The HZ may be viewed from a variety of perspectives. We propose an integrated definition of the HZ as: *the saturated transition zone between surface water and groundwater bodies that derives its specific physical (e.g. water temperature) and biogeochemical (e.g. steep chemical gradients) characteristics from active mixing of surface- and groundwater to provide a habitat and potential refugia for obligate and facultative species.*
3. Understanding aquifer-river interaction and resultant hyporheic exchange flows (HEF) is of prime importance for understanding hyporheic biogeochemistry and hydroecology. Spatially and temporally variable HEF control the mixing, transport and patterns of dissolved oxygen, nutrients and contaminants, redox conditions and physico-chemical habitat characteristics (e.g. water temperature) in the riverbed. HEF are related to differences in hydraulic head gradients and hydraulic conductivity.
4. The HZ is characterised by steep physico-chemical gradients. Temperature is a master variable driving many hyporheic biogeochemical and hydroecological processes, which is controlled by heat and water flux between the water column and riverbed.
5. The HZ is a buffer zone for the attenuation and release of nutrients and contaminants. The efficiency of most transformation processes depends on the presence of steep redox gradients, and existence of organic matter and microbial activity in the HZ
6. The nature and distribution of hyporheic organisms and their ecological functioning is influenced strongly by the physical and chemical conditions experienced within the HZ. The HZ is an interface and distinct ecotone where abiotic conditions may be intermediate between 'pure' surface water and groundwater environments.
7. Hyporheic fauna have a number of important stream ecosystem functions, which include: ecosystem engineering, processing of organic matter and trophic cascading, and transfer of organic matter and nutrients between the HZ and surface sediments.
8. Given the importance of the HZ to ecosystem and biogeochemical functioning and integrity, there is a clear need to maintain and protect GW/SW exchanges and connectivity when managing river systems. We advocate an integrated approach to water and land management that considers impacts on HZ hydrological-biogeochemical-ecological interactions and feedbacks.

5.2 Chapter Scope

There is growing interest in the hyporheic zone (HZ) due to its importance as a habitat and refugia for a range of organisms (e.g. Malcolm et al., 2002; Stubbington et al., 2009) and an area of biogeochemical cycling of nutrients and contaminants (e.g. Mulholland et al., 2008; Pinay et al., 2009).

This chapter aims to present a state-of-the-art, integrated review of key biogeochemical and hydroecological processes in the HZ and of its functions. The contents of this chapter are based on Krause et al. (2009). Hydrological, biogeochemical and ecological perspectives are synthesised to provide an integrated definition of the HZ. The chapter then considers key processes, functions and scaling. Hyporheic exchange flow (HEF) and heat transfer are discussed to provide background on the primary hydrological drivers of biogeochemical and ecological processes. Although the main focus of the chapter is on mechanistic understanding, approaches to modelling of HEF, contaminant transport and biogeochemical uptake are also reviewed in brief. Within the chapter subsections, a forward looking perspective on research challenges for the future is provided (key research needs are summarised in Chapter 12). It is beyond the scope of this chapter to consider all aspects of HZ biogeochemistry and hydroecology, so macrophytes are not considered in detail. Microbes and fish are considered elsewhere in this Handbook (Chapters 6 & 7).

5.3 Perspectives on the hyporheic zone (HZ)

The hyporheic zone may be viewed from a variety of perspectives with different research questions requiring different spatial and temporal scales of investigation (Krause *et al.*, 2009a) from patches (Trimmer et al., 2009) to individual bedforms (Packman and Bencala 2000), geomorphological units such as riffle-pool or step-pool sequences (Kasahara and Wondzell 2003), reaches (Harvey and Bencala 1993) and sub- to whole river basins (Datry and Larned., 2008).

From a *hydrological* perspective, the HZ is often delineated by the mixing ratio of surface water and groundwater (e.g. Harvey and Bencala, 1993). As a consequence of groundwater and surface water (GW-SW) interactions (ranging from 10-98% of surface water in the mixing zone), the HZ is characterised by steep physico-chemical gradients (Triska et al., 1993). In a *biogeochemical* context, the HZ is regarded as a redox reactive zone where downwelling surface water supplies dissolved oxygen, nutrients and dissolved organic carbon to enable high biogeochemical activity and transformation rates (e.g. Boulton et al., 1998; Mulholland et al., 2008; Krause et al. 2009b). Recently, the importance of the HZ for attenuating contaminants has been highlighted in a number of studies (Gandy et al., 2007). From an *ecological* perspective, the HZ is viewed as a habitat and potential refugium that is characterised by both benthic and subsurface (hypogean) species (e.g. Datry and Larned, 2008; Stubbington et al., 2009). Bringing together these definitions, in this chapter the HZ is viewed as:

the saturated transition zone between surface water and groundwater bodies that derives its specific physical (e.g. water temperature) and biogeochemical (e.g. steep chemical gradients) characteristics from active mixing of surface- and groundwater to provide a habitat and potential refugia for obligate and facultative species (Figure 5.1).

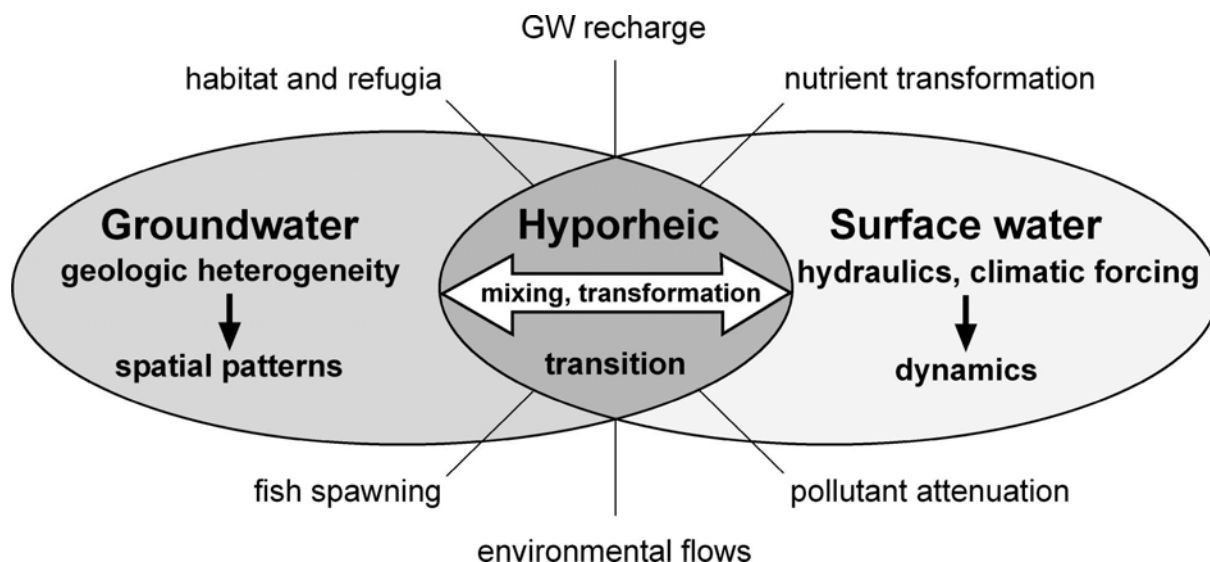

Figure 5.1 Hydroecological and biogeochemical functions of the hyporheic as a mixing and transition zone between groundwater and surface water environments, after Fleckenstein et al., 2008.

5.4 Processes, functions and scaling

5.4.1 Hydrology

Aquifer-river interactions and the resultant hyporheic exchange flows (HEF) are of prime importance for hyporheic biogeochemistry and hydroecology. HEF control the mixing, transport and patterns of dissolved oxygen, nutrients and contaminants, redox conditions and physico-chemical habitat characteristics (e.g. water temperature) in the riverbed. HEF are spatially and temporally dynamic, and control residence times of chemicals (e.g. pollutants) within areas of variable reactivity. Fundamentally, HEF are related to differences in hydraulic head gradients and hydraulic conductivity (Chapter 4).

Conditions and processes controlling HEF vary at different spatial scales. At the reach-scale, exchange of hyporheic water depends on variability in pressure distributions relating to channel bedform (e.g. Cardenas and Wilson, 2007), sediment permeability and particle size (e.g. Packman and Salehin, 2003). At broader scales, hyporheic water flux may be influenced by valley width, depth to bedrock, and aquifer properties (e.g. Brunke and Gonser 1997; Malcolm et al., 2005). Thus, hyporheic hydrology may be highly dynamic, reflecting the relative balance of hyporheic exchange driven by local bedform and groundwater discharge/recharge at a larger scale.

At smaller scales, patterns of riverbed permeability have been found to control HEF. In a number of studies, grain size distribution has been used to estimate hydraulic conductivity (e.g. Brunke and Gonser 1997). However, it remains a major challenge that riverbed hydraulic conductivity (K) can be spatially very heterogeneous and anisotropic. There is a great potential for the using the concept of hydrofacies (i.e. differentiation of homogeneous but anisotropic hydrogeologically meaningful units) as predictors of river-aquifer interactions. An increasing number of studies have applied successfully the hydrofacies approach to predict spatial patterns of streambed K heterogeneity (e.g. Fleckenstein and Fogg 2008).

The impact of colmation (i.e. blockage of streambed interstitial spaces by the ingress of fine sediments and organic material) on hydraulic conductivity have been characterised

in several experimental field and flume studies (e.g. Ryan and Packman 2006). Colmation processes control not only the hyporheic residence but also reaction times and; therefore, they have significant influence on the efficiency of hyporheic biogeochemical cycling and habitat conditions.

Vertical and lateral extents of the HZ are delineated frequently based on minima for hyporheic residence time (e.g. 10 days; Kasahara and Wondzell 2003). In the vertical dimension, while most research has been focused on near surface (upper 0.1-0.2 m of streambed) mixing of GW/SW, a number of recent studies have found that river water infiltrates deeper into the sediments (up to several meters) due to topographically-induced advective pumping (e.g. Puckett et al. 2008). Laterally, the HZ can extend into the riparian zone, including palaeo-channels and the wider floodplain, providing a significant spatially distributed habitat (Stanford and Ward, 1993).

A key issue for current and future investigations of hyporheic zone process dynamics is to understand the scale dependencies of HEF and its implications for streambed biogeochemistry and hydroecology at different scales. Up- and down-scaling techniques require to be developed for transferring mechanistic process knowledge of streambed permeability and hydraulic gradients. Attempts to develop scaling approaches for transferring HEF knowledge between scales include the use of proxies for physical streambed conditions. At larger (reach to basin) scales, proxies describing the stream morphology by riverbed concavity (e.g. Wondzell et al. 2006), riverbed slope (e.g. Harvey and Bencala 1993), sinuosity (e.g. Boano et al. 2006) or structural complexity (Kasahara and Wondzell 2003) have been used to predict potential HEF and hyporheic flow conditions. To investigate groundwater up-welling, hydraulic heads have been estimated in experimental or model based investigations (e.g. Cardenas and Wilson 2007). At the patch to reach scale, vertical hydraulic gradients (VHG) obtained from local piezometer measurements are widely used to describe direction and magnitude of GW/SW fluxes (Krause et al 2009b). At larger (sub-) catchment scales, HEF are usually derived by model simulations representing a function of the local groundwater flow field and resulting head gradients at the GW/SW interface (Krause et al. 2008). GW/SW exchange fluxes at these scales are spatially and temporally highly variable. For example, in lowland rivers, a seasonal inversion of HEF directions is relatively common, which affects substantially the transport of matter and energy (Figure 5.2).

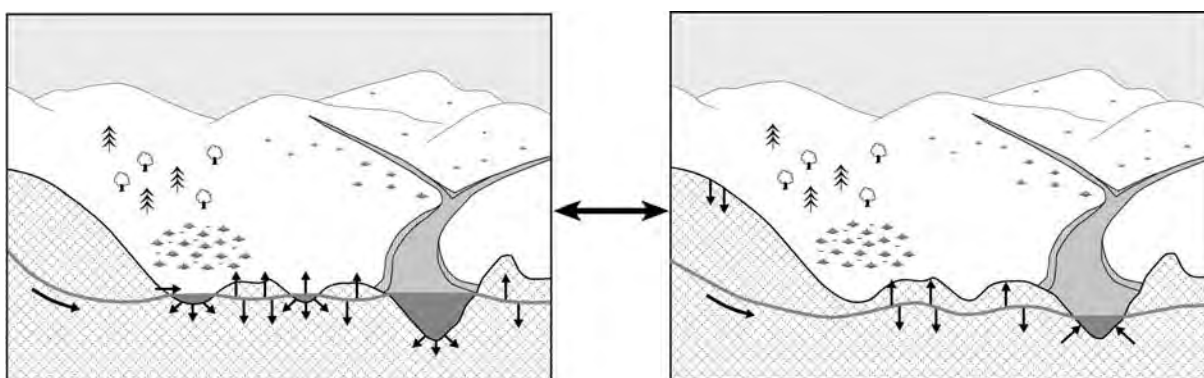

Figure 5.2 Seasonal dynamics of GW/SW exchange in lowland floodplains as function of variable river-aquifer pressure head gradients with mainly surface SW infiltration into GW aquifers during wet conditions and high SW levels (left schematic) and exfiltration of riparian GW into SW during dry summer conditions and low SW levels (right schematic).

To quantify the intensity of exchange between river and aquifer, concepts are applied such as the storage exchange fluxes (exchange volume per time per streambed length; e.g. Kasahara and Wondzell 2003), residence times (total RT and RT distributions; e.g. Kasahara and Wondzell 2003) as well as mixing ratios, which are estimated usually from environmental or artificial tracer injections or numerical models of coupled GW/SW flux (Triska et al 1993). The knowledge gained on the intensity of exchange fluxes, GW/SW water mixing ratios and hyporheic residence times is essential to assess hyporheic biogeochemical reactivity as well as temporally and spatially variable habitat conditions and functions.

5.4.2 Heat exchange and temperature

Temperature is a master variable driving hyporheic biogeochemical and hydroecological processes; therefore, it is important to consider heat exchanges in this chapter. Several studies have identified the significance of hyporheic processes in moderating river temperature and providing thermal refugia (Burkholder et al., 2008). In addition, it is recognised that temperature controls hyporheic biogeochemical processes (Boulton et al., 2008). Recent work has advanced understanding of the energy exchange processes that heat and cool rivers (reviewed by Webb et al., 2008). The few existing studies of bed heat budgets highlight the importance of energy transfer across the water column-sediment boundary. The energy balance at this interface (hence hyporheic temperature) is the sum of net radiative (short- and long-wave), conductive, convective and advective fluxes (Figure 5.3). The direction (source or sink) and relative contribution of heat exchanges at water column-bed compared with air-water interface varies temporally (Hannah et al., 2004), and spatially (between and within river systems; cf. Hannah et al., 2008). Several studies have flagged complexity in energy fluxes at the riverbed and banks because gains or losses of hyporheic and phreatic water are not only responsible for the advective transfer of heat but also determine substrate thermal gradients that drive conductive heat flow (e.g. Cardenas and Wilson, 2007).

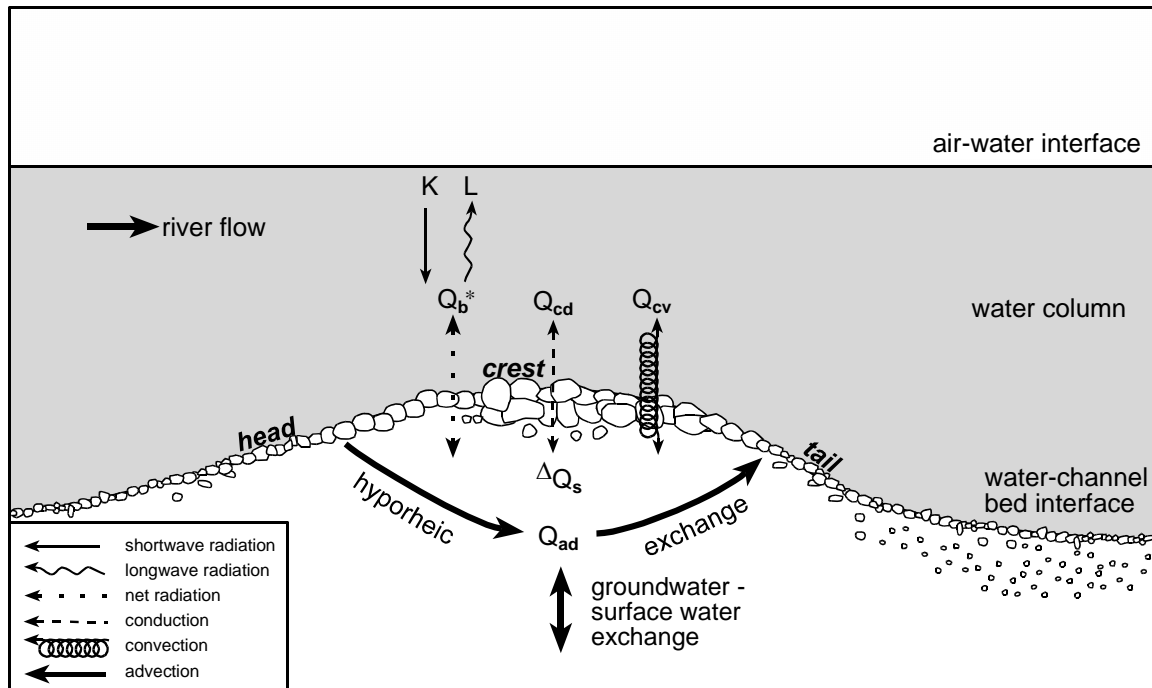

Figure 5.3 A schematic representation of energy and hydrological fluxes controlling hyporheic temperature. [Total energy available at water-channel bed (Q_{bn}) interface is the sum of net bed radiation (Q_b^*), bed conduction (Q_{cd}), convective transfers (Q_{cv}), instream advective transfers (Q_{ad}), and heat stored within the bed (ΔQ_s). Chemical and biological processes are not shown, as assumed to be negligible. After Hannah *et al.*, 2009].

The thermal regime of the hyporheic zone may be highly spatially and temporally dynamic due to the broad-scale climatic, hydrological and geological context (Cozzetto *et al.*, 2006) plus micro-scale variations in water column temperature (e.g. Brown *et al.*, 2006), bed morphology (e.g. Hannah *et al.*, 2009), bed sediment size and lithology (Malcolm *et al.*, 2002), substratum permeability and porosity (e.g. Constantz *et al.*, 2003), algal growth, macrophyte cover, and hydraulic flow distributions (e.g. Conant, 2004). These factors, in turn, influence water and heat exchange between the water column and riverbed.

Because riverbed thermal patterns respond to heat advection by water movement (Figure 5.3), there is currently particular interest in assessing the utility of riverbed temperature as a tool for inferring hydrological processes within the hyporheic zone, and especially identifying the nature and extent of local GW/SW interactions (e.g. Malcolm *et al.*, 2004). Indeed, it may be possible to use continuous bed temperature monitoring to provide new insights into hyporheic zone processes at spatial and temporal scales that cannot be revealed by spot measurement (e.g. Hannah *et al.*, 2009).

5.4.3 Biogeochemistry

The role of the HZ as a buffer zone for the attenuation of nutrients and contaminants is widely acknowledged (Smith, 2005). The efficiency of most transformation processes depends on the presence of steep redox gradients (including typically complex patterns of aerobic/ anaerobic conditions) and existence of organic matter and microbial activity in the HZ (Fisher *et al.* 1998).

Microbiologically mediated reaction efficiencies in the HZ are a function of hyporheic residence times, which depend on the length of the hyporheic flow path and the conductivity of streambed material (Chapter 3). The reaction efficiency in a particular hyporheic environment is controlled by its specific redox conditions, which determine reaction types and kinetics (McClain et al. 2003).

For example, the hyporheic denitrification capacity has been found to be controlled by the nitrate concentration (first order reaction kinetics), the abundance of anaerobic conditions and low concentrations of dissolved oxygen (DO) and the presence of reductive agents acting as electron donors such as organic carbon (heterotrophic denitrification) or pyrite (autotrophic denitrification) (e.g. Hill and Cardaci 2004). Therefore, despite the apparent oxic nature of river systems, the at least periodically anoxic conditions in the HZ have been shown to yield significant denitrification rates (e.g. Triska et al., 1993). Thus, hyporheic sediments can remove nutrients and thereby ameliorate the downstream effects of high N loads to stream systems (Triska et al., 1993).

In contrast to observed attenuation of nutrients in the HZ, some case studies also reported that transport and transformation of nutrients in hyporheic sediments with high metabolic rates resulted in the remineralisation of nutrients and net export into the surface water (Brunke and Gonser, 1997). Water returning to the channel may have such elevated levels of N and P that localised algal periphyton blooms occur (Claret and Fontvielle, 1997).

There have been a number of attempts to conceptualise nutrient retention efficiency in multi-scale models. The 'Material Spiralling Concept' of Fisher et al. (1998) describes rates of material cycling in river corridors as a function of processing lengths representing nested telescoping elements in a 'Telescope Ecosystem Model' with telescope elements being specific to subsystems (e.g. HZ sediments), substances (e.g. HZ nitrate) and processes (e.g. denitrification). Such concepts help to improve the understanding of material retention and nutrient transformation capacities in river corridors including the HZ.

Overall hyporheic transformation capacity depends on how hyporheic residence times and hyporheic redox conditions operate in space and time. For instance, Pinay et al. (2009) found that the influence of biological processes on N fluxes in HZ was a function of residence time and reaction rates associated with metabolic processes. In an injection experiment, biological removal rates of nitrate peaked within 1 hour of travel time after injection into the HZ (Figure 5.4).

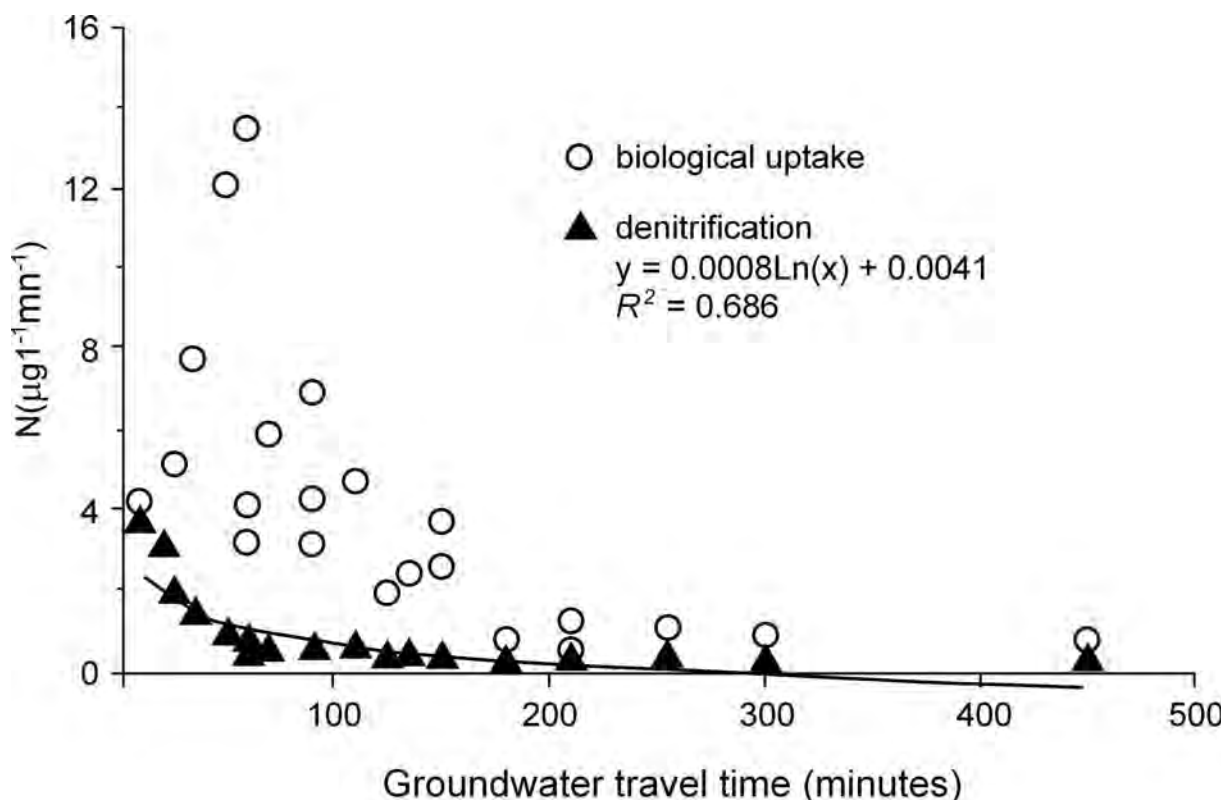

Figure 5.4 Relationship between the hyporheic water travel time after nitrate injection and the resulting biological uptake (open circles) and denitrification (filled triangles) during the same period. The equation corresponds to the best fit of the denitrification. (After Pinay *et al.*, 2009).

Complex patterns of nitrate attenuation or enrichment have been recorded at small scales. Krause *et al.* (2009b) showed nitrate concentration changes along the hyporheic flow path of a 30 m stream section to be spatially and temporally extremely diverse, with concentration increases occurring adjacent to attenuation hotspots. This significant spatial variability was interpreted as the result of complex patterns in HEF and hyporheic mixing, and also in streambed redox chemical status and anoxic/oxic conditions.

Superimposed on local streambed characteristics and processes, the overall nitrate concentrations at the GW/SW interface control the type and the rate of processes occurring in the HZ. In a pristine, low nitrate environment, the HZ often functions as an oxidation reactor where nitrification and aerobic respiration dominate, oxidizing surface water ammonia. For instance, Jones and Holmes (1996) reported that nitrification was the dominant N process in a Arizona desert stream with surface water ammonia being nitrified during aerated subsurface flow within a sandy gravel bar. Conversely, Pinay *et al.* (1994) reported that denitrification was the main N process in the HZ of the eutrophic Garonne River. Here, surface water nitrate was denitrified within the fine streambed sediments resulting in a decrease of nitrate concentration along the anoxic subsurface flow path.

HZ sediments have not only been investigated for their potential for nutrient transformation but also for the fate of contaminants and pollutants transported along hyporheic flow paths. Heavy metal contamination has been investigated mainly in relation to acid mine drainage and the introduction of mining wastes into streams and

groundwater (Smith, 2005). Acid mine drainage strongly affects biogeochemical process in the HZ (Fuller and Harvey 2000) because increased heavy metal concentrations impact on microbial community structures (Feris et al. 2003). Although some controlled experiments found heavy metal concentrations in streambed sediments to be poorly correlated with total microbial biomass in the HZ (Feris et al. 2003), the implications for hyporheic community structures were significant, especially during seasons with a high potential for microbial growth. This demonstrates that the hyporheic microbial community structure is a potentially useful indicator of heavy metal contamination in streambed sediments. Smith (2005) reviews case studies of heavy metal immobilisation and uptake of dissolved metals in groundwater or surface water during hyporheic passage. This report shows that bacterially mediated oxidation-reduction processes in the HZ have strong potential to reduce heavy metal concentrations. More information on HZ microbial ecology is provided in Chapter 6.

Depending on the hydrochemical conditions, hyporheic sediments have been found to have the potential to attenuate as well as mobilise heavy metals in the streambed (Gandy et al. 2007). Stream water input to the hyporheic sediments usually leads to increases in pH and DO concentrations that stimulates bacterial activity, thereby enhancing Fe and Mn oxidation. This results in increased rates of iron and manganese oxide precipitation and co-precipitation or adsorption of other metals such as zinc, arsenic, and copper (Figure 5.5). Conversely, respiration by micro-organisms and oxidative degradation of organic matter may lead to reducing conditions and subsequent dissolution of iron and manganese oxides and associated metals (Figure 5.5).

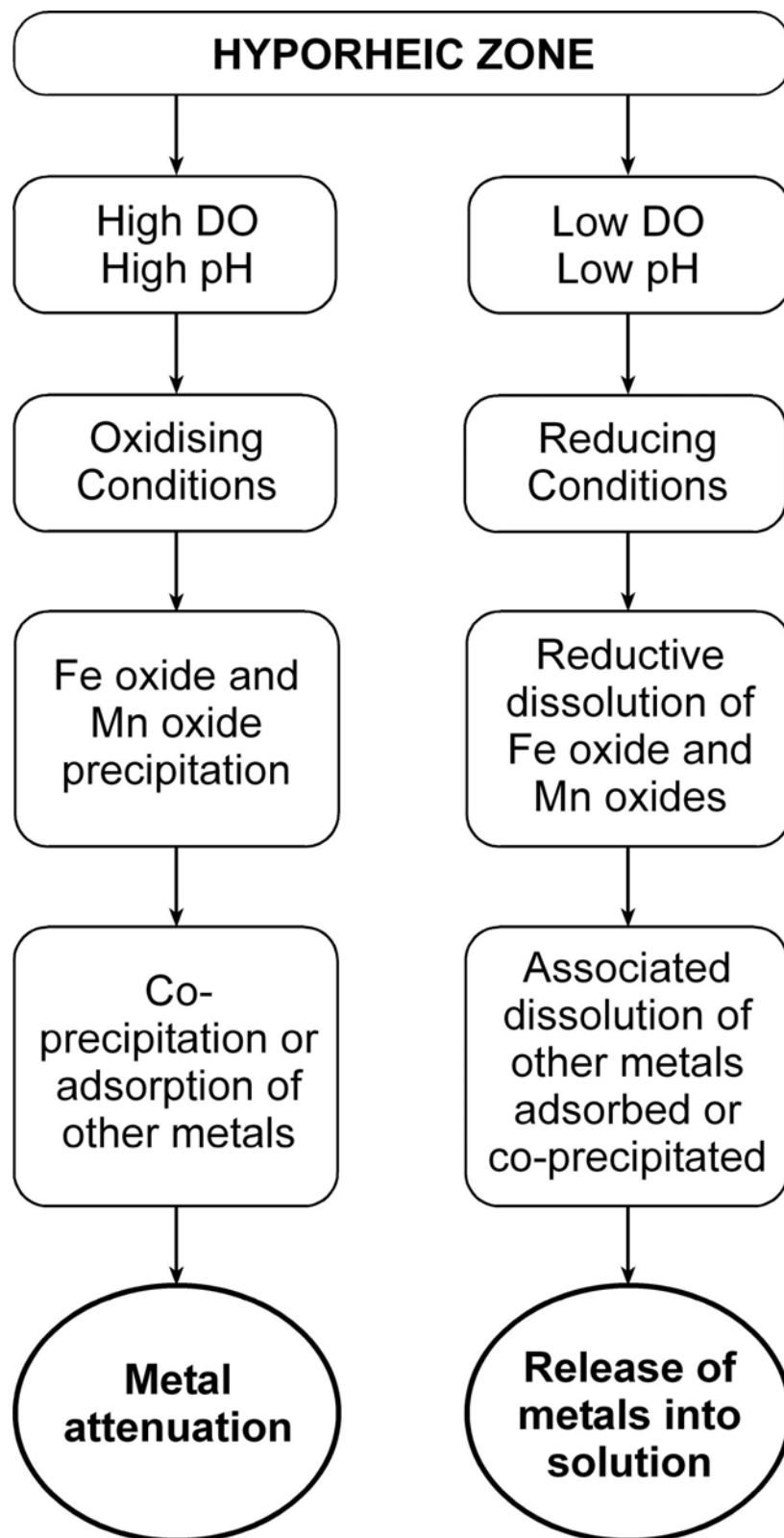

Figure 5.5 Generic redox and pH conditions for attenuation or release of mining-derived pollutants within the hyporheic zone (After Gandy et al., 2007).

The current knowledge of transport, transformation and potential attenuation of other contaminants as organic pollutants, volatile organic compounds (VOCs) or residuals of human waste products in the HZ is very limited. The presence of chlorinated VOCs in the HZ is associated with contaminated groundwater plumes discharging to rivers,

often arising from industrial sources. For example the chlorinated solvent, trichloroethene (TCE) is a widely-used, mobile and persistent compound found frequently in groundwater in urban areas, as a result of dry cleaning activities. The mapping and characterisation of these plumes and their interaction with the HZ has been achieved using piezometers and multi-level sampling devices at the reach to city scale (e.g. Ellis and Rivett, 2007). Less is known about the factors that control the attenuation of these compounds within the HZ. Several studies have demonstrated that organic-rich, low permeability environments, characterised by anaerobic conditions, have the potential to reduce the toxicity and change the composition of chlorinated VOC plumes through reductive dechlorination pathways (e.g. Conant et al., 2004). However, organic-rich sediments can also adsorb chlorinated VOCs. As a consequence, contaminants such as polychloroethene (PCE) can accumulate over time, so that hyporheic sediments become potential sources of river contamination should bed erosion occur (e.g. Conant et al., 2004). Phytoremediation can be an effective means of remediating chlorinated VOCs in the terrestrial environment; and the potential of aquatic plants and algae to sequester and transform these compounds has also been demonstrated (Nzengung et al., 2003), but the natural attenuation potential of macrophytes in the HZ for chlorinated VOCs has yet to be established.

5.4.4 Modelling of HEF, contaminant transport and biogeochemical uptake

Quantitative assessment of both HEF and biogeochemical cycling often relies on numerical models. A practitioners' overview of HZ modelling is provided in Chapter 9. In terms of reactive transport modelling of hyporheic processes or model-based assessment of the hyporheic potential for biogeochemical cycling, approaches may be divided into two different scale-dependent strategies.

At small spatial scales (patches to reaches), the quantification of attenuation potential or capacity is limited to estimations of transient storage components, which does not allow differentiation between hyporheic, in-channel (e.g. flow retardation by aquatic vegetation) and bank storage. However, transient storage models (combined with in-stream tracer applications) are widely used to determine the average spatial extent of the hyporheic mixing zone (Gooseff et al. 2003).

In modelling applications of GW/SW interactions at larger scales (sub-catchment to whole river basins), hyporheic flow processes are usually not explicitly included. If they are included, then transmissivity related controls of HEF are represented by a leakage boundary condition, which controls the river-aquifer exchange fluxes (e.g. river boundary condition in MODFLOW) in approaches of coupled GW/SW modelling (Krause et al. 2008). In terms of reactive transport modelling, the specific biogeochemical reactivity at river-aquifer interfaces is often not represented in model approaches at these scales.

Both experimental and model-based investigations proved the great importance of hyporheic transformation and attenuation processes at small scales, but more research is required to evaluate the importance of HZ nutrient cycling at larger (sub-catchment and upwards) scales.

5.4.5 Ecology

The ecological significance of the HZ in wider riverine ecosystem functioning is increasingly acknowledged (e.g. Boulton, 2008). The nature and distribution of hyporheic organisms and their ecological functioning is strongly influenced by the physical and chemical conditions experienced within the HZ (e.g. Datry et al., 2005).

Compared with the river channel, the HZ experiences reduced flow velocities, lower amplitude (daily and annual) water temperature cycles, strong physical and chemical gradients and increased substrate stability (Brunke and Gonser 1997). While compared with groundwater, the HZ experiences higher flow velocities, higher amplitude water temperature cycles and steeper physical and chemical gradients. Thus, the HZ provides an interface, and distinct ecotone, where abiotic conditions may be intermediate between surface water and true groundwater (Gibert et al., 1994; Boulton and Hancock 2006; Stubbington et al., 2009; Table 5.1).

The community of organisms inhabiting the HZ are collectively known as '*hyporheos*' (Boulton et al., 1998). These can be classified in a variety of ways based on morphology, behaviour and/ or adaptations to life underground (Sket 2008), but the most widely applied classification of organisms within the HZ and porous alluvium is the tripartite system summarised by Gibert et al. (1994) and more recently by Boulton (2007): (1) stygoxenes, (2) stygophiles; and (3) stygobites. Stygoxenes are organisms that have no affinity with groundwater habitats but occur there accidentally due to passive infiltration. Stygophiles are organisms that have a greater affinity to the hyporheic environment and actively exploit resources and the available habitat (e.g., during unfavourable environmental conditions or for protection from predators). Stygophiles can be subdivided further into three categories: (a) occasional hyporheos – typically early instars of organisms that usually predominate in benthic habitats at later stages of development; (b) amphibites – taxa that are dependent on access to hyporheic and surface water habitats at some points during their life-cycle and; (c) permanent hyporheos – organisms that may be present in the HZ during all life stages but may also be able to complete their life-cycle in benthic habitats. Stygobites are organisms that may display some adaptation for subterranean life and they are obligatory inhabitants of hypogean habitats, including the HZ, as well as deeper groundwater dominated habitats such as aquifers and caves.

In most hyporheic environments small invertebrates less than 1 mm in size (meiofauna including microcrustaceans, tardigrades, rotifers, small oligochaetes and nematodes) dominate the invertebrate community (Hakenkamp and Palmer, 2000). The micro-distribution and biodiversity of meiofaunal communities is influenced by a range of factors including sediment grain-size (Brunke and Gonser 1997), oxygen tension, rate and direction of flow, organic matter availability (Malard et al., 2003) and micro-topography (Olsen and Townsend, 2003). However, understanding and quantifying the influence of individual factors at different spatial scales has proved difficult.

Macroinvertebrate (> 1 mm in size) biodiversity is dominated by peracarid Crustacea (particularly Amphipoda and Isopoda), stonefly and mayfly nymphs, and other aquatic insects (Boulton 2008). However, macroinvertebrate biodiversity is typically lower than that of meiofauna. Biodiversity and the relative contribution of stygobites, stygophiles and stygoxenes at any point in space and time may also reflect the disturbance history (particularly floods), whether water is upwelling or down-welling and substratum stability (Dole-Olivier et al., 1997).

Since the HZ may experience different physical and chemical conditions to surface water and groundwater, it has the potential to function as a refugium for benthic fauna during times of disturbance such as high flows (flooding) or low flows (drought) (e.g. Dole-Olivier et al., 1997; Stubbington et al., 2009). Some animals actively burrow into the sediments when disturbances occur (Fenoglio et al., 2006). After the disturbance has passed, organisms can re-colonise benthic habitats. Thus, the HZ may serve to enhance the resilience of the benthic community to disturbance and influence river recovery following perturbations. Indeed, the presence and extent of HZ refugium may play an important role in shaping the composition and geographical distribution of the benthic community (Robertson et al., 2008).

The functional roles of hyporheic fauna in stream ecosystems have been reviewed by Boulton (2007) and include ecosystem engineering, processing of organic matter and trophic cascading, and transfer of organic matter and nutrients between the HZ and surface sediments.

5.4.5.1 *Ecosystem engineering*

The collective effect of the activities of organisms on their environment has been termed 'ecosystem engineering' (Mermillod-Blondin and Rosenberg, 2006). Although hyporheic organisms are typically small and elongated (vermiform), many have the ability to burrow in fine sediments and modify and move sediment particles (bioturbation). As a result, fauna within the HZ may have a significant physical impact on substrate porosity. In addition, the pelletisation and/or physical breakdown of fine sediment particles and organic matter as a result of ingestion, egestion and/or excretion of faecal pellets may further modify the particle size distribution and the hydraulic properties of HZ sediments. This may enhance solute transport and activate aerobic processes within the HZ (Mermillod-Blondin et al., 2003). A series of laboratory experiments has demonstrated that the activities of hyporheic organisms, such as Asellidae (Isopoda) Chironomidae (Diptera) and Tubificidae (Oligochata), modify the distribution of sediment particles and the nature of water fluxes (e.g. Mermillod-Blondin et al., 2003). In particular, the galleries of tubificid worms (Tubificidae: Oligochata) and the release of faeces stimulated denitrification and organic matter mineralisation and increased surface water penetration into the HZ (e.g. Mermillod-Blondin et al., 2003). The ability of larger organisms, such as niphargids and stonefly larvae, to move fine sediments and enhance HZ hydraulic conductivity has also been demonstrated experimentally (e.g. Wood et al., 2005), although *in situ* field observations have been limited to date.

5.4.5.2 *Processing of organic matter and trophic cascading*

Foodwebs within the HZ are largely heterotrophic, with the exception of chemoautotrophic bacteria, and are driven by external inputs of dissolved and particulate organic matter (Culver and Pipan 2009). Since most unpolluted groundwaters have limited organic carbon concentrations, the availability of trophic resources is dependent on the connectivity of the HZ with the surface channel (good connectivity enhances allochthonous organic carbon input into the HZ).

Hyporheic metabolism is assumed to result in a fairly rapid renewal of organic carbon in deeper sediments. There are two likely mechanisms. Firstly the episodic burial of particulate organic carbon (POC) following a disturbance (e.g. Metzler and Smock, 1990), with this carbon subsequently being processed by hyporheic invertebrates (for example through shredding coarse particulate material, consuming particulate organic matter, biofilms and bacteria). Secondly the transport of POC or dissolved organic carbon (DOC) into hyporheic sediments by stream water or groundwater intrusions (Findlay et al., 1993). In most cases, interstitial flows are too slow to transport particulate matter more than a short distance into these sediments, thus DOC is probably the major source of carbon in the HZ. Few, if any, invertebrates can use DOC directly as a carbon source and thus the initial uptake of DOC is by microbial communities (Findlay et al., 2003). Microbial communities and biofilms are the primary consumers within the HZ (Leichtfroid 2007) and make a significant contribution to riverine respiration, metabolism and energy transfer (Atkinson et al., 2008), although this may be spatially and temporally highly variable (Tillman et al., 2003). These biofilms are a major trophic resource for the diverse range of organisms recorded

within the HZ (Leichtfreid, 2007) and secondary production within the HZ may form a significant proportion of that occurring in the whole river ecosystem.

Invertebrate fauna, particularly meiofauna, are associated with the highest rates of consumption within the HZ and play a significant role in transferring energy between microbiota and larger animals by predation and consuming organic matter including macrofaunal faecal pellets (Robertson et al. 2000). In sand bed rivers where meiofauna predominate, secondary production within the HZ can comprise over 60% of whole river productivity (Smock et al., 1992). Meiofauna constitute a significant proportion of secondary production in the HZ of most alluvial rivers due to their rapid turnover in numbers (Robertson et al., 2000). They can form a major component of the diet of predatory meiofauna, macroinvertebrates and small and juvenile fish (e.g. Mann 1997). In some studies, stream invertebrates have been shown to be heavily reliant on the hyporheos as a source of food (e.g. Burrell and Ledger 2003). For some New Zealand streams, up to 76% of the annual production of individual taxa was derived from the HZ (e.g. Collier et al., 2004). Thus invertebrates play an important role in the processing and consumption of organic carbon in the HZ and this is, in part, dependent on the bacteria within the gut of individual taxa. These bacteria are also a potentially important resource for the hyporheic community as a whole as when faecal pellets are excreted they may be consumed by other organisms (Joyce et al. 2007). In addition, the grazing of biofilms may prevent over-proliferation and consequently may regulate carbon and nitrogen cycling in hyporheic environments (Robertson et al. 2000).

5.4.5.3 *Transfer of organic matter of nutrients between the hyporheic zone and surface sediments*

Organisms within benthic and hyporheic habitats are capable of migrating vertically, laterally and longitudinally (Boulton 2007). This has been demonstrated clearly in the case of amphibite stoneflies that spend almost all of the nymph stage within the HZ and may travel considerable distances from the river channel before returning to the stream to emerge, mate and oviposit (e.g. Stanford and Ward, 1993). In some alluvial systems this represents a significant export of energy and nutrients from the HZ (e.g. Perry and Perry, 1986). When groundwater is strongly upwelling or during floods, hyporheic organisms may also be flushed into surface waters where it is assumed they may be preyed upon by benthic predators (e.g. Sket, 2008).

5.4.6 A hydroecological perspective on hyporheic zone management

The conceptual model in Figure 5.6 identifies hydrological and biogeochemical process interactions that influence invertebrate communities during periods of 'unimpaired' and 'impaired' (i.e. reduced) flow (Stubbington et al., 2009). When river flow and bed integrity are unimpaired, the HZ and the adjacent parafluvial zone are saturated with good vertical and lateral HEF, clear thermal gradients, maintenance of interstitial permeability/ porosity (Malcolm et al. 2005) and in-stream storage or export of nutrients (Figure 5.6a). As a result, the HZ may be one of the primary locations for processing of nutrients and dissolved and particulate organic matter (see above). When flow is impaired, HEF and connectivity with the parafluvial zone will be reduced (Figure 5.6b). Riparian vegetation may begin to experience water stress, and marginal and in-stream vegetation may become partially or even fully exposed. Depending on whether the reach is upwelling or downwelling, the HZ may still function as a transient store or source of nutrients (e.g. Stofleth et al. 2008), although the rate of exchange is likely to be significantly lower. In the absence of flushing flows, fine sediments (<2 mm in size) may be deposited onto the riverbed, infiltrating and potentially clogging the interstices (Brunke 1999). This reduces the competency of HEF and the porosity and permeability

of the sediments, with consequences for the supply of dissolved solutes and oxygen (Youngson et al. 2004). This also potentially reduces living space for larger hyporheic invertebrates as well as sediment-associated benthos.

(a)

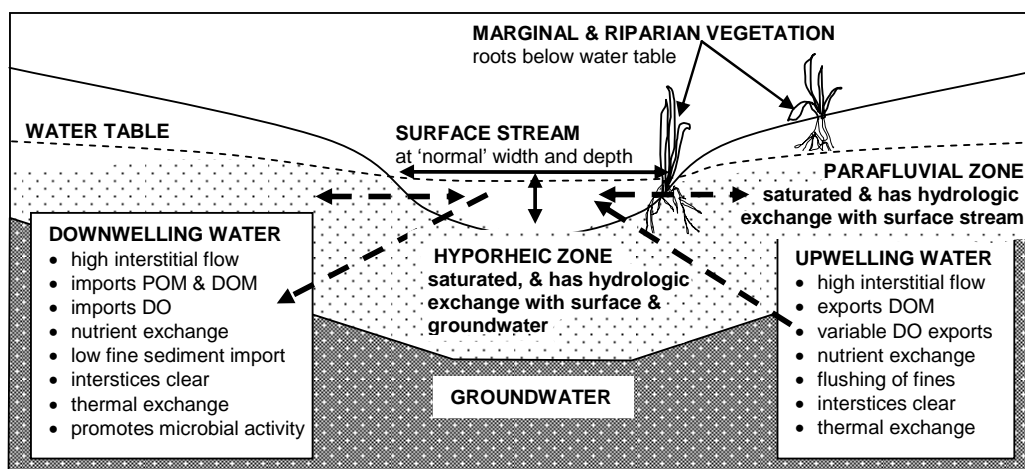

(b)

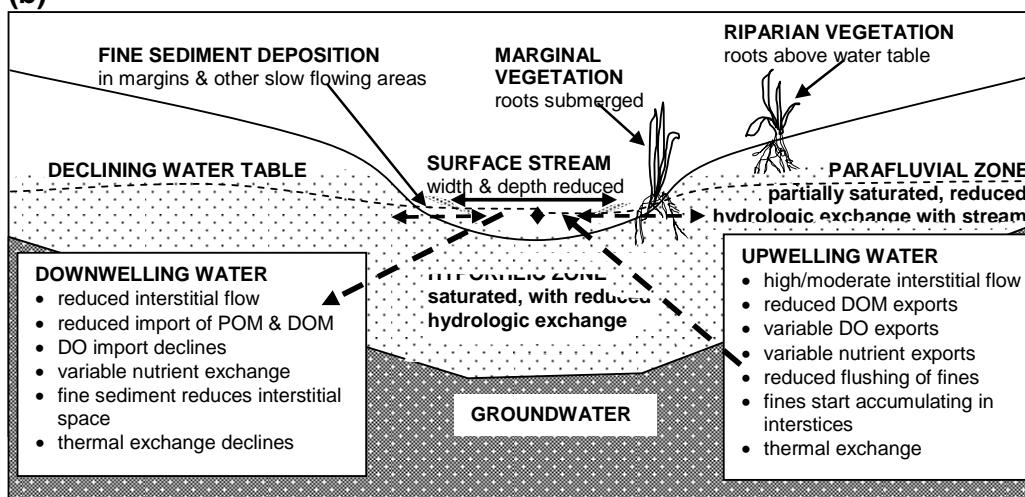

Figure 5.6 Conceptual model of ecologically significant processes and interactions between the benthic and hyporheic zones as a result of low flow and supra-seasonal drought (a) unimpaired flow and (b) low/base flow (After Stubbington *et al.*, 2009).

Given the importance of the HZ to stream ecosystem and biogeochemical functioning and integrity, the need to maintain and protect vertical linkages within riverine systems is widely accepted. However, the vertical linkages within many riverine systems have been reduced, impaired or lost as a result of anthropogenic activities (Brunke and Gonser, 1997; Hancock 2002). The need to develop and implement techniques to facilitate the rehabilitate and restoration of surface water and groundwater interaction within the HZ as part of 'holistic' river management strategies has been advocated (Boulton 2007). However, examples of this in practice are currently limited (Kasahara and Hill, 2008) and the restoration of surface water and HZ interactions remains an ongoing goal for future research.

Table 5.1 Summary of comparative physical and biological characteristics of groundwater, hyporheic and surface water environments.

	Descriptive characteristic of environment		
	Groundwater	Hyporheos	Surface Water
Physical characteristic			
Light	Constant darkness	Constant darkness	Daylight fluctuations
Current velocity	Low	Intermediate	High
Annual and daily temperature range	Very low	Low	High
Substrate stability	High	Intermediate	Low
Gradient of physico-chemical parameters	Low	Steep	Steep
Biological characteristics			
Habitat diversity	Low	Intermediate	High
Food webs	Simple and short	Intermediate	Complex and long
Productivity	Low	Intermediate	High

6 Microbial and invertebrate ecology

6.1 Introduction

Microbial ecology processes underpin the key functional biogeochemical components of the hyporheic zone. Therefore the microbial ecology is crucial to the understanding the role of the HZ in larger ecosystems, observing change and assessing the potential for natural attenuation.

This review examines the microbial ecology of the HZ in the context of global processes and cycles as well as specific characteristics within the HZ. It discusses the applications and limitations of them modern methods available to investigate HZ ecology and finally contributes to gaps in knowledge that may be relevant to management policies as discussed in Chapter 2. This complements the chapter on 'Biogeochemistry and hydroecology of the hyporheic zone' (Chapter 5) which considers the HZ as a habitat and refugia for a range of organisms and as an area of biogeochemical cycling of nutrients and contaminants.

6.2 Microbial ecology of protozoa, fungi and bacteria: global scale

Microbial ecology is the relationship of microorganisms with one another and with their environment. It concerns the three major domains of life - Eukaryota, Archaea, and Bacteria — as well as viruses. Microorganisms, are present in virtually all of our planet's environments, including some of the most extreme and hence impact the entire biosphere. Microbes, especially bacteria, often engage in relationships with other organisms, and these relationships affect the ecosystem. Microbes are the backbone of all ecosystems (Falkowski et al., 2008), but even more so in the zones without light where energy cannot come from photosynthesis. In these zones, chemosynthetic microbes provide energy and carbon to the other organisms. Other microbes are decomposers, with the ability to recycle nutrients from others waste products. These microbes play a pivotal role in biogeochemical cycles - the nitrogen cycle, the phosphorus cycle and the carbon cycle all depend on microorganisms. In addition, microbes exhibit high degrees of genetic flexibility due to the high level of horizontal gene transfer among microbial communities which means they can adapt according to the prevailing conditions. As a result they exhibit through their diversity and genetic acquisition mechanisms, a high degree of functional redundancy that gives a high degree of functional stability (Torsvik and Øvreås, 2002). Microbial ecology is underpinned by its inherent morphological, structural, metabolic, behavioural and ecological diversity.

(http://www.biotechnology.uwc.ac.za/teaching/BTY327/bty327_lec3_07.ppt).

6.3 Global scale biogeochemical processes and cycles

The Earth is essentially a closed system for matter and all the elements continually cycle through Earth's systems - the atmosphere, hydrosphere, biosphere, and lithosphere - on time scales that range from a few days to millions of years. These

biogeochemical cycles comprise biological, geological, and chemical processes and each takes many different pathways and has various reservoirs, or storage places, where elements may reside for short or long periods of time. Each of the chemical, biological, and geological processes varies in their rates of cycling depending on its chemical reactivity.

There is no scope for reviews on individual biogeochemical cycles (McClain et al., 1994) but an appreciation of the N cycle provides an oversight into the cyclical nature of the other cycles. Nitrogen exists in a variety of forms in natural systems and its compounds are involved in numerous biological and abiotic processes. Nitrogen, in its gaseous form of N_2 , makes up almost 80 percent of the atmosphere, which constitutes the major storage pool in the complex cycle of nitrogen through ecosystems. Some of this gas is converted in soils and waters to ammonia (NH_3), ammonium (NH_4^+), or many other nitrogen compounds. The process is known as nitrogen fixation, and, in the absence of industrial fertilisers, is the primary source of nitrogen to all living things. Biological nitrogen fixation is microbially-mediated. Once nitrogen has been fixed it can either be oxidised for energy (nitrification) or assimilated by an organism into its biomass (ammonia assimilation). Nitrogen, fixed as proteins, eventually returns via the nitrogen cycle to its original form of nitrogen gas in the air. The process of decomposition through denitrification generates mainly N_2 with nitrous oxide (N_2O) in much smaller quantities (<10%). The disruption of the nitrogen cycle by human activity plays an important role in a wide-range of environmental problems including the contamination of groundwater when nitrogen oxides are chemically transformed back to either N_2 or to nitrate or nitrite compounds causing river management problems.

6.4 Hyporheic zone as a biological entity

In the HZ biogeochemical cycling, microbial ecology and the ecology of higher animals should not be considered as discrete compartments but rather as an interactive system. This is often best described as the microbial loop (Figure 6.1) showing flow of carbon from the microbial level and its release to higher trophic levels (Figure 6.1). Feris et al. (2003) describe the hyporheic zone as a spatially and temporally dynamic ecotone which provides connectivity between terrestrial, groundwater, and lotic habitats. It lies beneath the channel of a stream, often extending great distances laterally in the subsurface, and is an essential part of lotic ecosystems. The microbial transformations of dissolved and particulate nutrients taking place in the hyporheic zone have been shown to influence both macro-invertebrate and algal assemblages and may play a role in the productivity of riparian vegetation. This zone supports an active microbial community involved in nutrient cycling and nutrient retention and this community constitute the majority of the biomass and activity in lotic ecosystems (Craft et al., 2002, Fischer and Pusch, 2001, Pusch et al., 1998) and may contribute up to 96% of the ecosystem respiration (Naegeli and Uehlinger, 1997). Therefore, Feris et al. (2003) noted that the microbial transformations in the HZ of dissolved and particulate nutrients influence both the macro-invertebrate and algal communities and furthermore influence the productivity in lotic systems and beyond (Barlocher and Murdoch, 1989, Jones et al., 1995a, Pusch et al., 1998).

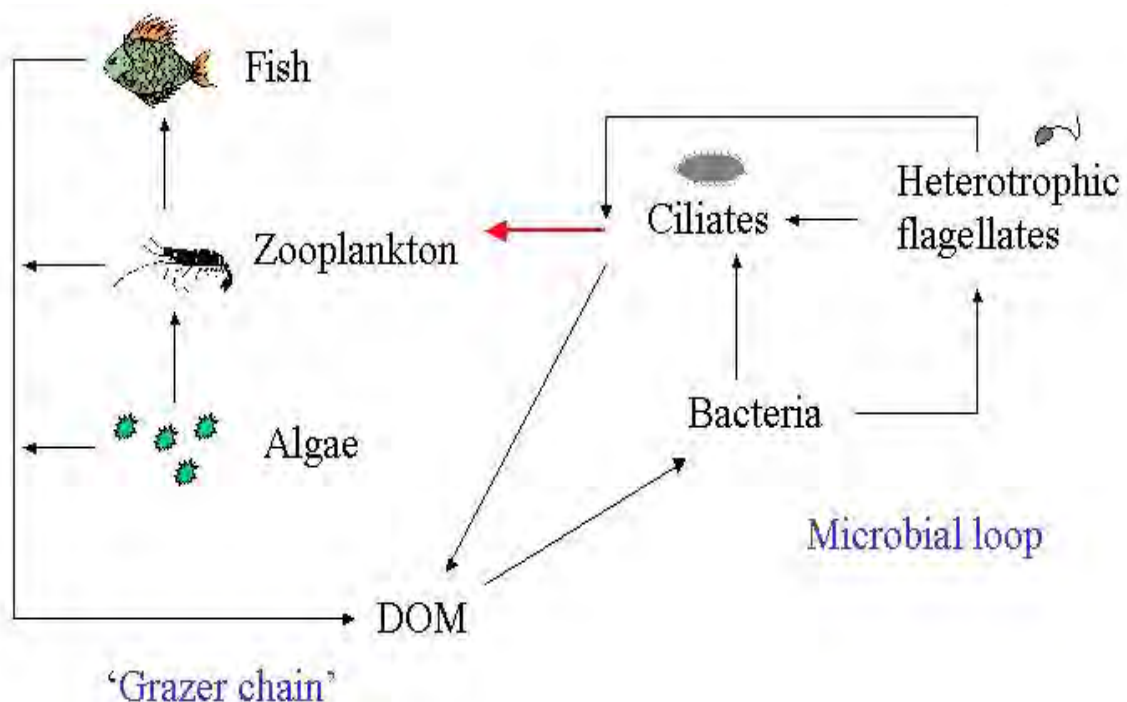

Figure 6.1 Microbial loop (omitting viral component). The microbial loop is important as it reintroduces dissolved organic carbon back into the food web.

6.5 Microbial ecology in the hyporheic zone

Little is known about the microbial activities in sediments of, for instance, large lowland rivers, despite their potentially high influence (Fischer et al., 2005, Boulton et al., 1998). Fischer and co-workers suggest that their presence causes the sediment to act like an animal's liver, as a detoxifier through the nitrogen and carbon cycles (Fischer et al., 2005). Therefore the microbial ecology is crucial to the understanding the role of the HZ in large ecosystems.

6.6 Physical location of microbes

Microbial diversity can be morphological, structural, metabolic, behavioural or ecological, but this is driven by the habitat. In most environments certain groups or species dominate, usually in response to prevailing conditions such as temperature or redox potential, however, other organisms for whom the environment is not optimal can still grow there. The community structure may change in terms of the total number of species but the relative proportions of species may also change, with a few species (often linked by functionality) becoming numerically dominant as they benefit from the prevailing chemical environment. If the environment changes again then other species will become dominant, some may be 'new' arrivals but the population often still reflects the earlier dominant species. Most microbes in the environment are substrate limited and respond by size reduction, lower activity and increased cell division time (when they divide they do so by reductive cell division, hence the smaller size). Increases in nutrient levels reverses this process (apart from culture on high nutrient media) (Torsvik and Øvreås, 2002).

The microbes in HZ can be found in plankton form (in free flows larger flows), in interstitial areas (that allow both settling and movement) and in biofilms (a complex matrix of polysaccharide, cell products and a diversity of microorganisms). In planktonic form numbers of free 'swimming' bacteria are often related to the sediment load in that water, and are typically in the range of 10^6 - 10^8 bacteria per ml river water. For bacteria in interstitial water, for example, it was shown that in the Töss River (gravel-bed stream, Switzerland) bacterial abundances ranged between 1.6×10^5 to 4.8×10^8 cells/ml interstitial between depths (Brunke and Fischer, 1999). The upper range was two orders higher than most lake waters. This change with depth was significantly modulated by the type of hydrological exchange. The bacterial carbon portion of total Particulate Organic Carbon (POC) varied between 0.06 % and 5.3 % and tended to decrease with depth. Bacteria were most numerous at sediment depths where inflow of stream water occurred, but had been attenuated. Bacterial production was highest in hyporheic interstices dominated by surface water inflow. Bacterial abundance and production were strongly correlated to interstitial particulate organic matter; the best predictor for both was the content of particulate nitrogen, explaining 75 % and 72 % of the variation, respectively. Abundance of several hyporheic invertebrate taxa, taxa richness and total invertebrate density were positively correlated to bacterial abundance and production. The hyporheic fauna exhibited a gradient between interstitial positions influenced by surface water and those dominated by phreatic ground water. The coupling of sediment depth and hydrological exchange type revealed flow path connections as being superimposed vectors in determining hyporheic abiotic and biotic gradients.

6.7 Biofilms

When assessing microbial activity at a process level or microbial diversity at a community level, biofilms shouldn't be ignored over ease of analysing water samples.

Biofilms vary in nature from larger visible streamers (such as those found in hot springs) to microscopic mucus coating around sediment particles. These biofilms will account for the majority of microbial biomass and comprise a diversity of microorganisms arranged within a complex extracellular polysaccharide often with a thickness that isolates the bulk of the matrix from the immediate environment, limits gaseous and chemical exchange and consequently will generate redox gradients within the structure. Biofilms are dynamic, they undergo recruitment and loss (usually through sloughing processes), and they often have sufficient 3D structure to create flows in micro-channels. A number of cycles co-exist within biofilms (e.g. sulfur and nitrogen (Ramsing et al., 1993)). The redox potential within is sufficient to allow methanogenesis to occur despite external flows being oxygenated. Often synergies develop as specific niches are created by producers and consumers e.g. methane, methanogenesis, and methane oxidation.

6.8 Microbial diversity (functional groups)

Microbial diversity can also be considered in the form of functional groups. Microbes, and bacteria in particular, show considerable functional and metabolic diversity which enables them to derive energy from sources other than organic carbon and to use other electron acceptors other than oxygen, hence their cosmopolitan abundance in diverse and extreme habitats. Heterotrophic bacteria, tend to dominate systems, particularly when oxygen is available. These utilise organic carbon directly and can consume simple to complex compounds. However, once oxygen is consumed and

anaerobic conditions below the surface layers prevail, carbon cycling processes depend on the redox environment (see Figure 6.2). Decomposition is faster under aerobic conditions than that occurring in anaerobic zones.

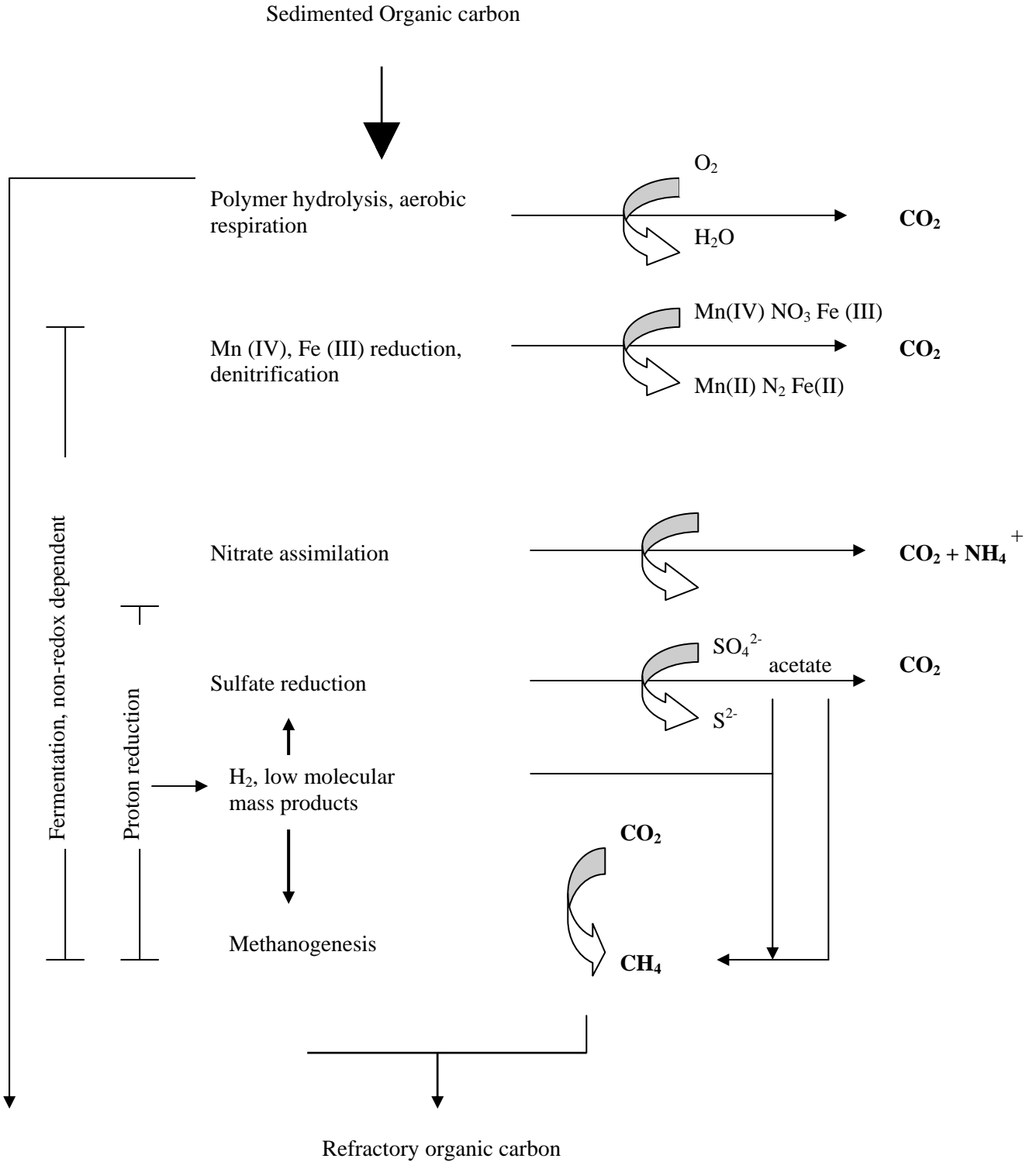

Figure 6.2 Depth distribution and interactions of decomposition process in buried sediments (from Jones (1985)).

6.9 Decomposition under anaerobic conditions

It is very important to view the HZ environment as a series of interacting processes rather than a single process such as methanogenesis (see Figure 6.2).

Carbon turnover in the presence of electron acceptors involves the interaction of the carbon, nitrogen and sulfur cycles. In the absence of electron acceptors other methods of energy conservation become significant (Triska et al., 1993). Inter-species hydrogen-transfer permits the use of otherwise energetically unfavourable reactions. Conservation of the energy in polyphosphate bonds and reduction of iron (II) and manganese (IV) to produce more energetically favourable end-products are mechanisms available in benthic environments. The reduction of carbon dioxide to acetate is a potential hydrogen sink in some circumstances (Figure 6.2).

Methanogenesis occurs at the lowest redox potential (e.g. -200mV compared with methane oxidation at +250mV), with previous processes having depleted oxygen, iron (III), sulfate, nitrate and manganese with the concomitant accumulation of carbon dioxide (a by-product of most catabolic processes) and hydrogen (Figure 6.2).

Denitrification processes have been identified in the HZ (Triska et al., 1993), this process reduces nitrate, converting it to nitrogen gas by a number of steps allowing the coupled oxidation of organic compounds in the presence of depleted oxygen. The source of nitrate may be through inflowing water but *in situ* nitrification is also possible thus the N cycle is coupled directly and can occur in anaerobic pockets within a predominantly aerobic zone or within biofilms. It is best observed, as a process, in a hypereutrophic pond (Finlay et al., 1997) where processing at times is so fast that nitrate is not detected. The contribution of denitrification in HZ has not been determined.

Little information exists on methanogenesis in HZ. The process was measured in anaerobic sediments beneath a stream channel and found that it dominated the anaerobic sediment but also was active in the aerobic sediment (Jones et al., 1994, Jones et al., 1995b). This highly contradictory finding suggests anaerobic pockets still exist in the sediment or within biofilms despite methanogens being extremely oxygen sensitive.

6.10 Chemolithotrophy: energy via inorganic compounds

It is apparent that the HZ is biologically active with the potential to carry out processes which occur across the full redox gradient but it is important to assess processes as part of the whole system rather than in isolation.

The HZ is not considered an extreme environment but does differ from its surrounding environment as it is the interface between reduced groundwater and oxidised surface waters. Therefore it is an ideal environment for functionally active chemolithotrophic bacteria which derive their energy from oxidation of inorganic materials like iron, sulfur, ammonia and nitrite (Storey et al., 1999). However, the most well characterised functional group of bacteria in the HZ are those involved in nitrification converting ammonia via nitrite to nitrate; (Triska et al., 1993). Their activity depends on prevailing ammonia concentrations in the HZ and this is reflected in their relatively low abundance compared with heterotrophic bacteria where dissolved organic carbon is often 100 fold higher than ammonia (Storey et al., 2004). Jones et al. showed chemoautotrophic production was approximately 1% of the total and of that less than 30% was nitrification

(Jones et al., 1994). Reliance on these figures is compromised by the degree to which the DOC is microbially available as this has not been defined (Storey et al., 1999). Despite their relatively low abundance nitrifiers can have a significant effect on oxygen consumption sometimes demanding 50% of the available oxygen for productivity which is significantly less than that of the heterotrophs (Storey et al., 1999).

In the absence of ammonia, other bacteria are able to utilise iron (II), manganese (II) or reduced sulfur (e.g. elemental sulphur or sulfide) as their sole energy source. Bacterial oxidation of iron is favoured at a reduction potential of around 300mv (see figure 6.2) under slightly acidic conditions (Hacket and Lehr, 1985). These conditions are critical to the process but exist within the HZ (Hacket and Lehr, 1985). Manganese oxidation is a bacterially mediated process. Wielinga and co-workers showed that a high proportion of culturable bacteria from the HZ had this capacity yet their numbers, as with nitrifiers and ammonia, are influenced by the prevailing manganese concentration (Wielinga et al., 1994). Manganese and iron oxidation yield less energy than ammonia oxidation and their presence is greatly influenced by redox state of the feeding waters (McClain et al., 1994). Sulfur often occurs in groundwater at high concentrations, most commonly as sulfate. Reduced sulfur requires a low redox potential (see Fig 2) not commonly seen in HZ although possible in the near stream zone. Sulfide oxidation is more energetically favourable than nitrification, with higher sulfur than nitrogen in groundwater, sulfide oxidisers may contribute more to HZ productivity if conditions are favourable (Storey et al., 1999).

Hlaváková et al. (2005) examined the HZ in a holistic manner. They studied the distribution of dissolved oxygen, nitrate, sulfate, carbon dioxide and dissolved organic carbon (DOC), acetate and lactate in the stream and interstitial water along the subsurface flow path in the hyporheic zone of a small lowland stream (Hlavacova et al., 2005). Sediments were found to act as a source of nitrous oxide and methane. Interstitial methane concentrations were significantly higher than those from surface water, and were significantly lower in the relatively well oxygenated down-welling zone than in the rather anoxic upwelling zone. The interstitial concentrations of oxygen, nitrate and sulfate showed significant decline along the subsurface flowpath, while concentrations of carbon dioxide, nitrous oxide, DOC, acetate and lactate remained unchanged. Nitrous oxide production potential reached 71-100% of denitrification potential. This demonstrated that that respiration of oxygen, nitrate and sulfate and methanogenesis may coexist within the hyporheic zone and that anaerobic metabolism is an important pathway in organic carbon cycling in the Sitka stream sediments (anaerobic microbial metabolism in hyporheic sediment of a gravel bar in a small lowland stream (Hlavacova et al., 2005).

6.11 Bacterial Community identity

Limited information shows that bacterial communities have a high resilience and respond to changing conditions.

Very little information exists on community structure or dynamics of bacteria that carry out processes in the HZ. This may be related to limitations of methodological strategy and or lack of defined research programmes. Where processes are identified, it is not unrealistic to assume bacteria identified with similar function are active in the HZ. For example, 18 genera of iron oxidising bacteria have been identified in wetlands springs, identified in nature by their orange coloration (Hacket and Lehr, 1985) so there is an expectation that they will occur in HZ receiving reduced groundwaters. where the absence of oxygen has preserved the iron valency (Storey et al., 1999) . Similarly

nitrifying bacteria identified by (Whitby et al., 1999; 2001) may be present depending upon prevailing conditions and ammonia concentration which is known to drive the local diversity of ammonia oxidisers. The most extensive information of HZ bacterial structure is provided by Feris (Feris et al., 2003a; 2003b; 2004a; 2004b) who used molecular methods for analysis. They identified bacterial communities in a perturbed HZ system exposed to heavy metal where the overall biomass showed no correlation with metal content. The community structure did respond to exposure with positive shifts in gamma-proteobacteria, beta- proteobacteria responding negatively, and alpha and cyanobacteria both unaffected. They therefore showed that the community responded in structure but not overall biomass to the presence of heavy metals. Furthermore HZ microbial communities responded rapidly to exposure with heavy metals (Feris et al., 2004b) and the response was greatest during the seasons when growth potential was highest (Feris et al., 2004a)

6.12 Fungi

Fungi play an important but as yet unquantified role in the HZ.

Both fungi and bacteria are metabolically very versatile yet fungal contribution to productivity is universally understudied as in the case of HZ. Early work by Barlocher and Murdoch (1989) reported the occurrence of fungi but not their distribution. Later Barlocher examined fungi from the hyporheic zone of a springbrook in southern Ontario, Canada (Barlocher et al., 2006). The number of identified species significantly decreased with depth, and was highest on deciduous leaves and lowest on wood. Season had no significant effect on species numbers. Molecular analysis showed phylotypes were significantly affected by season but not by depth. Both season and section level significantly affected the relative frequency of the 10 most common phylotypes; and consistently raised temperature lowered diversity (Barlocher et al., 2008). It was suggested that aquatic hyphomycetes and other fungi readily disperse within the hyporheic zone, and that their relative scarcity in this habitat is due to a lack of suitable substrates. Bacterial and fungal numbers decrease with decreasing particle size (Sinsabaugh and Findlay, 1995). Therefore fungal numbers and activity may be linked to presence of coarse matter. Fungi are often associated not only with coarse particles but have also been found in close association with bacteria in biofilms (some species can utilise dissolved organic matter. (Barlocher and Murdoch, 1989)

6.13 Protozoa

Protozoa are relatively better studied than bacteria and fungi and play an important role in the continuity of the food web.

Protozoa usually range from 10–50 µm, but can grow up to 1 mm. They exist throughout aqueous environments and soil, occupying a range of trophic levels. As predators, they prey upon unicellular or filamentous algae, bacteria, and microfungi and they play a role as both herbivores and consumers in the decomposer link of the food chain. Protozoa also play a vital role in controlling bacteria populations and biomass. As components of the micro- and meiofauna, protozoa are an important food source for microinvertebrates. Thus, the ecological role of protozoa in the transfer of bacterial and algal production to successive trophic levels is important. Few data exist on protozoa and the HZ but there is some knowledge about enumeration, distribution, and grazing.

A number of studies have examined depth distribution and showed that species richness varies both spatially and temporally (Andrushchyshyn et al., 2007). They

examined ciliated protozoans (phylum Ciliophora collected from five sites in a shallow groundwater system in southern Ontario, Canada) and showed that species richness was high with 170 ciliate species belonging to 89 genera identified. Highest species richness (86) occurred between 20 and 60 cm, and typically decreased below 60 cm. Leven et al. showed ciliate numbers and biomasses were greatest at the sediment surface and declined significantly with increasing sample depth with mean abundances varied between 0 and 895 cells per ml of sediment, and the mean ciliate biomass ranged between 0 and 5.3 mg of carbon per ml of sediment. Similarly Packroff and Zwick investigated Ciliata in sandy bed sediments (Packroff and Zwick, 1998). Abundance varied greatly, the observed maximum being about 4000 per ml sediment. There was no longitudinal gradient of ciliate abundance. Seasonal variation was apparent. Andrushchyshyn et al. (2007) showed ciliate densities were also seasonally and spatially variable with densities lowest in winter. Packroff and Zwick showed no clear seasonal pattern at one site; but at the other three sites it peaked in spring and early summer. Cleven (2004) and, Cleven and Konigs (2007) showed abundance and biomass varied seasonally, with maximum values in late autumn and early winter and minimum values in early summer.

With respect to diversity Andrushchyshyn et al. (2007) showed that at all depths, small (< 50 µm) bacterivorous ciliates typically dominated, but omnivorous and predatory species were also present (combined, up to 30% of the average density). Several ciliate genera, traditionally considered planktonic, occurred at low densities from 40 cm down to 100 cm. The main factors influencing the shallow groundwater ciliate communities were depth and temperature with dissolved oxygen also appeared to influence these communities in that they typically comprised genera that preferred either low-oxygen or anaerobic conditions; they also showed abundances of both flagellates and ciliates were higher in the hyporheic zone than in surface sediments. Flagellates were distributed at all depths over the sampling period, but densities were highest at 30-40-cm depth before a spate. Ciliate depth distribution also showed high densities from 10 to 40 cm and patches of high abundance occurred at 30-40 cm. Preliminary estimates of resilience suggested that flagellates were more resilient than ciliates and that large flagellate individuals and ciliates <50 µm in the hyporheic zone had higher resilience values than those in the streambed surface sediments. Several ciliate genera, traditionally considered planktonic, occurred at low densities from 40 cm down to 100 cm (Andrushchyshyn et al., 2007). At all depths, small (< 50 µm) bacterivorous ciliates typically dominated, but omnivorous and predatory species were also present (Andrushchyshyn et al., 2007, Packroff and Zwick, 1998).

Neubacher and co-workers showed grazing by ciliates has no influence on abundance and growth of nitrifying bacteria and nitrification as they showed no significant selective grazing or food preferences for any bacterial taxon or any size class or morphotype (Neubacher et al., 2008). On the bacterial side, neither an active defence mechanism of the nitrifying bacteria against ciliate grazing, such as changes in morphology, nor competition for resources were observed (Neubacher et al., 2008). Konigs and Cleven also suggest that interstitial ciliate grazing impact on bacteria biomass and production was too low to represent an important link in the carbon flow of the hyporheic zone under study (Konigs and Cleven, 2007). Despite this they showed that ciliate generation times ranged between 4.8 and 9.9 days with ingestion rates for *C. margaritaceum*, other small scuticociliates and *Pleuronema* spp being 26, 50 and 86 bacteria per individual predator per hour, respectively (Konigs and Cleven, 2007).

6.14 Microbial pathogens in HZ

Microbial pathogens in HZ are understudied and this has issues for river management particularly with respect to recreational bathing and freshwater and marine environments.

There is a vast amount of information on the presence and survival of microbial quality indicators in groundwater and streams, as well as rivers and lakes (John and Rose, 2005), but limited information relating to the HZ. Of that, Halda-Alija showed the total number of bacteria, cultivated heterotrophic aerobic bacteria, and enteric bacteria showed significant differences between winter and summer. The cultivated numbers of heterotrophic aerobic bacteria and enteric bacteria were significantly more abundant in summer than in winter. The abundance of enteric bacteria was 12.9% in an upwelling zone and 9.8% in a downwelling zone in summer. Most of the enteric bacterial strains were identified as *Enterobacter cloacae* and *E. agglomerans* and showed significant spatial variation and were heterogeneously distributed along the stream. Temperature, inorganic nutrients, and occurrence of anoxic zones affected the distribution of enteric bacteria. Transport between groundwater and HZ depends on factors such as cell size, size of source, porosity, pore size of sediments and degree of entrapment on surfaces or in biofilms and grazing rates (Pickup et al., 2003). However, surface flows, river entry and settling as typified by *Cryptosporidium* oocysts, allows entry of pathogens into HZ. Furthermore pore water flow, particle filtration and gravitational settling, all parameters used to predict solute and colloid exchange, may be useful for 'biocolloids' such as *Cryptosporidium* oocysts (e.g. see (Searcy et al., 2006). Exchange mechanisms between flow and sediment probably regulate pathogen flow in rivers through deposition, only to create a reservoir of pathogens in the sediment that may be released in high numbers during high flow events (Searcy et al., 2006, Pickup et al., 2003).

6.15 HZ is a biological entity

As stated prior to this section, it is important that HZ should be viewed as a complex biological entity functioning at a number of trophic levels typified by the microbial loop (Figure 6.1: Falkowski et al., 2008). Leichtfried (2007) although describing lotic systems showed that the complexity and faunal-associations were still relevant in the HZ. He stated:

'Organic matter is the basic source of energy for consumers in ecosystems. Most of the organic matter is allochthonous, The energy content of unprocessed organic matter is not readily available to all consumers; it has to be processed by the microbial community. Microorganisms are most active in biofilms, comprised of fungi, bacteria, protozoa etc., and their organic excretions attached to surfaces. The colonizable surface area in sediments is negatively correlated with the grain size. Therefore, the largest amounts of organic matter are likely to occur in small grain size classes, which shows that biofilms are an important component of the organic matter pool. Most of the meiobenthic species, which play also a very important role in these processes, are closely connected to biofilms. These and their associated communities are doubtless an important food source for benthic consumers. The main energy pathway passes from organic matter (either particulate or dissolved) to the microbial community in biofilms, which transforms the organic matter and makes it available and palatable to benthic consumers. Wherever the benthic community is living, either in bed sediments, the energy stored in biofilms or their associated communities is mostly used'

Furthermore Storey et al. (1999) predicted that the biofilm growth form of interstitial micro-organisms will create a variety of microniches, allowing coexistence of a great diversity of microbial types, and promoting the activity of some otherwise poor competitors. It is further predicted that the confluence of reduced groundwaters and aerobic surface waters will favour chemolithotrophic processes in the HZ, but that these will contribute significantly to hyporheic production only if surface water is very low in dissolved organic carbon, or the groundwater is extremely reduced, such as by the influence of riparian wetlands. A variety of anaerobic respiratory pathways, such as nitrate, iron (III), sulfate and even methanogenic respiration will be employed in the HZ, with biofilm dynamics permitting these to occur even in aerobic sediments. Anaerobic pathways may account for a significant proportion of total hyporheic organic matter mineralization.

6.16 Investigating microbial ecology of HZ

6.16.1 Overview

Molecular techniques are now available to answer hypothesis-driven HZ science. Understanding the limitations of these approaches is as important as their application.

Information on microbial ecology of the HZ is sparse and comprises observational rather than functional ecology. The availability and ease of application of classical and molecular microbiological methods is leading to more detailed studies that link the exploration of microbial community structure, with not only their function, but with their response and resilience to perturbation by a number of chemical challenges. This section explores the methods available but avoids detailed methodology and some limitations that are important to factor into larger scale interpretation of microbial responses. Molecular and classical microbial approaches that can be applied to the HZ are summarised in Figure 6.3 (Head et al., 1998) and reviewed by Pusch et al. (1998). All procedures require sampling and sample preparation which is a crucial step in any analysis and often determines the success of any down-stream analytical procedure. Classical methods include growth on solid or liquid media supplemented by co-factors and single or multiple carbon sources, incubation at relevant temperatures, purification and subsequent identification; direct counts are achieved by microscopy on unstained, non-specifically stained or specifically stained cells (Pickup, 1995, Pickup et al., 2003). Non specific stains such as DNA stains allow total bacteria to be counted whilst specific stains such as viability dyes, molecular fluorescent probes or antibodies allow specific cells, at a species or group level, to be observed.

Molecular methods (Figure 6.3) based on the extraction of DNA, whether from an environmental sample or a culture, require sample processing involving lysis to generate a DNA extract that is assumed to be representative of the sample under analysis. The DNA extract can then be analysed by a number of routes. The most favoured is amplification of specific target sequences, often the 16S rRNA gene, by polymer chain reaction protocols (PCR: (Head et al., 1998). Once completed amplified DNA can be subjected to cloning and sequencing and sequences can then be compared with DNA sequence libraries to allow the identity of the sequence relative to other clustered sequences to be determined. From this, function can be inferred if the sequences are corroborated with those from organisms of known function.

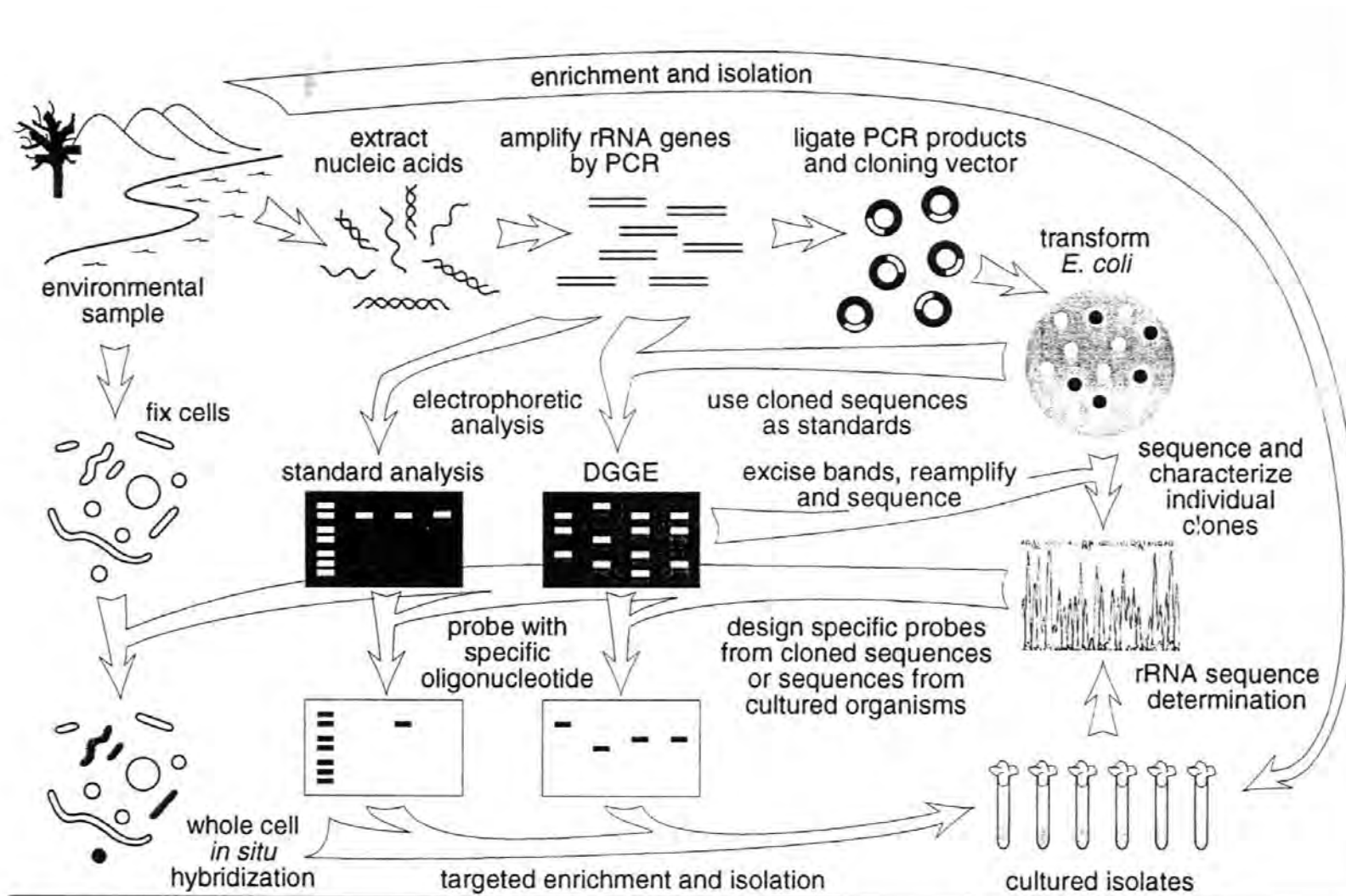

Figure 6.3 Common methodological approaches to studying the microbial ecology of the HZ (Head et al., 1999).

Modification of the PCR procedure and subsequent separation of amplified DNA by gel electrophoresis density or temperature gradient allows analysis of complex samples, with each amplicon separated by sequence not size and representing a 'bacterial species'. The resulting 'bar-code' of electrophoretic bands allows easy comparison with other samples and the degree of similarity (hence the diversity) to be determined. Furthermore the electrophoretic bands can be excised and sequenced thus identifying novel or common 'species' from the sample.

The knowledge gained at a sequence level can be utilised in developing more primers for PCR or probes for direct detection and enumeration of cells in a sample. Oligonucleotide probes can be linked to fluorescent molecules for direct insertion into cells in a sample. The cells for which the probe is specific can then be counted by fluorescent microscope or automated analyser. One disadvantage with many molecular approaches is that they do not distinguish between live and dead cells, however use of innovative techniques such as the incorporation of radioactively labelled compounds or heavy isotopes can reveal the active community (Earl et al., 2003, Whitby et al., 2001).

Molecular techniques advance at a pace and whole sample sequencing is now a feasible but expensive option (454 sequencing), as are the 'omic technologies allowing multi-species identification from single samples (microarrays) and assessments of metabolic capability (metabolomics).

6.16.2 Limitations to methods

It is very important to optimise all procedures against known standards and controls. It has to be recognised that no single technique will satisfy all requirements and their choice depends on the question and the characteristics of the study site (Hendricks, 1993). However, any study that combines hydrology and biology in HZ will yield important information.

This section is not exhaustive, but provides an important appreciation of the limitations to even standard methods. Interpretation of data is often compromised by a lack of understanding of the inherent limitations imposed by the techniques employed (Pickup 1999, (Head et al., 1998).

6.16.2.1 Sampling strategy

HZ samples may be collected using a range of approaches (see Environment Agency Report SC030155/SR3). However, once a sample has been removed from a site it is no longer representative of that environment or micro-environment and that imposes a major and immediate limitation on any future interpretation of data derived from that sample particularly when microbial activity is a focus (Pickup, 1995). For example, a sample that undergoes active methanogenesis will show a reduced, if not zero, activity once removed from a site and exposed to oxygen (Hall et al. 1990). Even if, anaerobic conditions are restored, if there is any subsequent activity it will be reduced (Hall et al., 1990;1996). Therefore during sampling, the fewer disturbances the better which intuitively suggests that *in situ* experimentation is the preferred option. However, this is not always feasible. The least representative sample method is destructive sampling (e.g. by grab sampler). With sediments this destroys redox gradients and often disrupts intimate biological, chemical and physical associations. A feasible option is to remove the sample but maintain the sample integrity, for example using core samplers that can extract intact cores and maintain overlying water, and be manipulated and maintained at *in situ* temperatures (Hall et al., 1990, Pickup, 1995).

6.16.2.2 *Classical microbial methods*

A major limitation of population studies, particularly those based on enumeration is experimental design which requires replication of samples and the statistical treatment of the subsequent data (Hall et al., 1990). It is important to stress that an impractical degree of replication may be required to work to a given level of statistical significance. The degree of variability of microbiological data, on both temporal and spatial scales is reported by Hall et al. (1990), further emphasizing the caution which must be exercised in interpreting data.

A further limitation to research into microbial populations is an inability to isolate and culture the majority of bacteria. There has always been a discrepancy between cell numbers obtained by direct and viable counting methods and studies have concluded that culturable bacteria represented only 0.01—12.5% of the viable bacterial population in terrestrial and aquatic environments (Pickup, 1995). Furthermore, some bacteria have been shown to become unculturable but retain their viability after exposure to the environment and have been called 'non-culturable but viable' (NCBV). This complicates both the detection and enumeration of microorganisms. In addition, NCBV state is often wrongly attributed to some microorganisms, although confirmatory methods have been developed. There are two other factors which contribute to this discrepancy. The direct count cannot distinguish between cells that are viable, NCBV, or dead. Conversely, media used for the isolation of viable bacteria may actively select against growth because they are too rich in nutrients or do not supply essential co-factors (Pickup, 1995, Pickup et al., 2003).

Methods have been developed that go some way towards distinguishing viable cells under epifluorescence microscopy. However, as with bacterial isolation procedures, it is clear that all experimental conditions are not suitable for all samples. Despite some limitations, viability assessment assays represent a bridge between counting culturable bacteria and direct counts and has been termed a direct viable count PVC; (Pickup, 1995, Pickup et al., 2003).

6.16.2.3 *Molecular Microbial Ecology*

While we have undoubtedly gained much new and valuable knowledge using the molecular techniques described, as with all methods, there are important limitations that must be minimised, eradicated, or, at the very least, recognised. As an example, we focus on the limitations the extraction of nucleic acids from natural samples. However other limitations exist for other techniques and these should be investigated prior to use.

6.16.2.4 *Nucleic Acid Extraction*

A major limitation of all DNA-based methods described is the quantitative recovery of nucleic acids from environmental samples (Head et al., 1998). This is because

- a) If you do not know the total amount of nucleic acids present in a sample, then it is difficult to assess the efficiency of recovery by any extraction technique.
- b) Spores will be less readily lysed than vegetative cells.
- c) Gram-positive cells are more resistant to cell lysis than Gram-negative cells and smaller cells (0.3–1.2 μm) are also more resistant to lysis.
- d) Not all methods are suitable for all environments. It is possible that the same lysis technique may give different results with different types of

sample such as water, sediment, or soil, so the degree of cell lysis should be determined independently.

It is paramount that any extraction procedure is optimised to target DNA being extracted as different targets require different strategies. For instance relatively gentle lysis is required for ammonia oxidising bacteria in environmental samples (Whitby et al., 2001) whereas high speed agitation in the presence of glass microbeads is required for some mycobacteria pathogens where gentle lysis is totally ineffective (Pickup et al., 2006).

7 Fish ecology and the hyporheic zone

7.1 Summary of key messages

1. The hyporheic zone strongly influences the incubating embryos of gravel spawning fish species, particularly those species that lay their eggs at depth within the gravel, such as salmonids, rather than gravel-surface spawners or free-swimming life stages.
2. During the intragravel phase, the developing salmonid embryos require a continuous supply of cool, clean, well oxygenated water for respiration and to flush away waste metabolites. This extends from spawning between October and December to emergence from the gravel between April and June.
3. The survival and development of embryos can be influenced by sedimentary processes and surface water - groundwater interactions in the hyporheic zone that produce a complex incubating environment that can vary spatially and temporally.
4. Long residence groundwater that is often low in dissolved oxygen is a natural feature of the hyporheic zone, and can impact embryo development through either direct mortality or retarded development that may affect subsequent performance and survival.
5. The extent and influence of low dissolved oxygen-groundwater varies in relation to catchment-scale features, reach-scale features, and also in relation to seasonal variation and individual flow events such as spates.
6. As rivers warm under the influence of climate change, the potentially cooler groundwater (provided it contains sufficient dissolved oxygen) may provide valuable thermal refugia for coldwater fish species.

7.2 Introduction

For most of their lives, native British riverine fish species live in the open river channel. However, a number of species will spawn in the gravel substrate. Salmonids will bury their eggs at depths ranging from 0.05 to 0.5 m in the gravels, although British salmonid species including brown trout (and migratory brown trout – sea trout) and Atlantic salmon have typical burial depths of 0.05 - 0.3 m (DeVries, 1997). Greater burial depth and duration of exposure to the hyporheic environment gives rise to increased likelihood of fine sediment impact and of mortality or developmental impairment through low oxygen concentrations. Other fish species present in England and Wales including grayling (*Thymallus thymallus*) and lampreys (*Petromyzon* and *Lampetra* spp.) also lay their eggs in shallow nests in the gravel substrate, while shads (*Alosa* spp.), dace (*Leuciscus leuciscus*), gudgeon (*Gobio gobio*), barbel (*Barbus barbus*) and chub (*Leuciscus cephalus*) typically lay their eggs on the gravel surface. However, these surface spawners are likely to be less affected by hyporheic zone processes, including impacts of fine sediment intrusion, and consequently most research to date has focussed on various species of deeper gravel spawning salmonids.

Although the influence of groundwater and hyporheic exchange processes on embryo survival has been recognised for some time (e.g. Vaux, 1968; Hansen, 1975), the term hyporheic was not common in fisheries research until relatively recently. Furthermore

much of the historical salmon embryo research focussed on a limited set of hyporheic zone processes related to sedimentary characteristics that did not include a wider understanding of the importance of groundwater-surface water exchange processes (Malcolm et al., 2008).

7.3 Salmonid spawning behaviour/process

Salmon and trout typically spawn in the autumn and early winter. The female selects a suitable spawning site based on hydraulic and sedimentary characteristics and begins the process of nest, or redd, construction. The female lies close to the stream bed, turns on her side and vigorously flaps her tail, without actually touching the gravel substrate. The hydraulic forces of this action lift the gravel particles up from the stream bed and the flow of the stream then wash these particles a short way downstream – the larger particles are deposited quickly just a short distance downstream and the finer particles are flushed further downstream. The female continues this action until a depression, or pot, is created with a depth of up to 0.3 m below the stream bed. The excavated material forms a heap, or tail, just downstream of the pot (Figure 7.1). The female then lays some eggs into this pot, and the attending male immediately fertilises these, before the female continues the redd construction slightly upstream of the deposited eggs. This action covers those eggs and creates a new pot into which another batch of eggs are laid and fertilised (Figure 7.1). This process may continue until several pockets of eggs are laid, fertilised and covered within the redd (Ottaway et al., 1981; Taggart et al., 2001). When freshly created, this redd has a characteristic shape and a relatively porous structure, with the finer sand and silt particles having been washed out of the larger gravel matrix (Kondolf et al., 1993). In many circumstances redds will contain the ova from more than one female, with later spawners using the pit from previous spawning activity.

7.4 Timing of spawning and incubation

Salmonid spawning activity in the British Isles usually peaks in November and December, but spawning has been recorded in all months from September to March (Frost and Brown, 1967; Mann et al., 1989; Shields et al., 2005). The number of eggs laid and the burial depth is typically related to body size, with female salmon and trout producing approximately 1100 eggs per kilogram of body weight (Maitland and Campbell, 1992). Salmon are typically larger than trout, so lay proportionally greater numbers of eggs. The fertilised eggs incubate within the stream gravel at a rate that is dependent on the prevailing water temperature (Humpesch, 1985; Elliott et al., 1987; Crisp, 1988) and dissolved oxygen concentrations (Hamor and Garside, 1976). For example, eggs laid in November or early December will hatch in February or early March, then spend a further 5-6 weeks developing within the gravel before emerging into the stream as free-swimming juveniles.

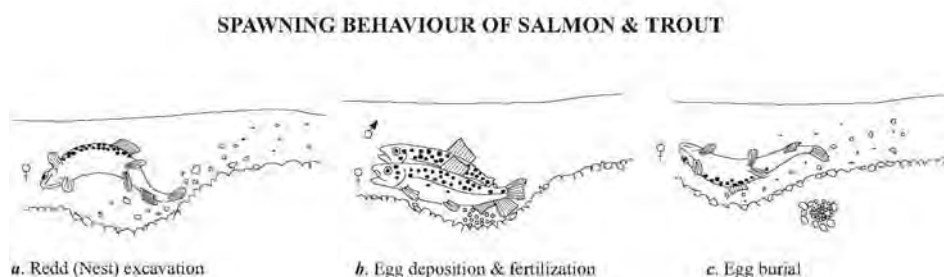

Figure 7.1 Spawning behaviour of salmonids after Soulsby et al., 2001.

7.5 Factors affecting embryo development

The survival of embryos can be very variable and is influenced by a complex range of interacting factors in the intra-gravel, hyporheic environment (Figure 7.2). Critically, the developing embryos require a continuous supply of cool, well oxygenated water, both for respiration and to flush away waste metabolites.

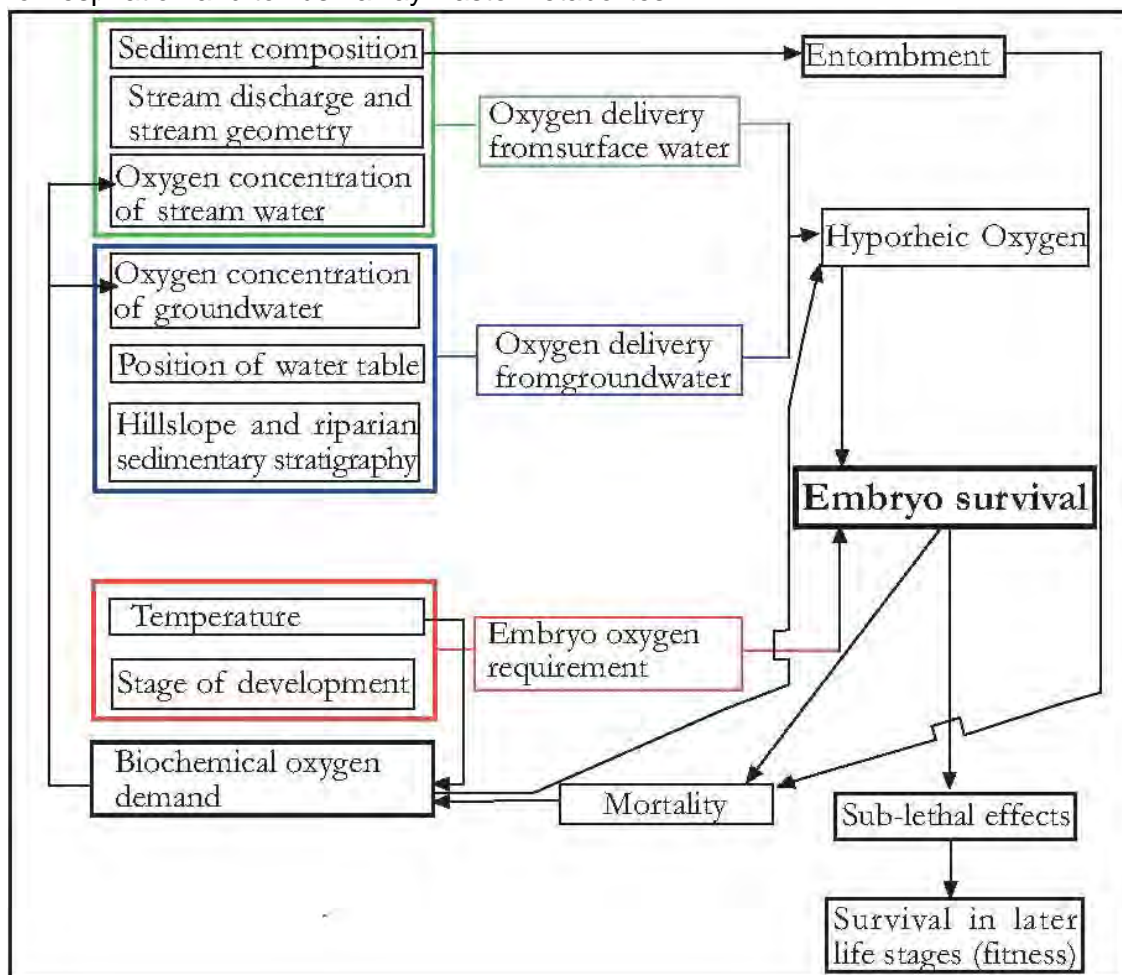

Figure 7.2 Conceptual diagram showing the complex interaction of processes that can influence salmon embryo survival. Hyporheic water quality is determined by the relative contributions of groundwater (blue) and surface water (green) which are in turn influenced by a variety of interacting physical and chemical processes. The oxygen requirement of embryos (red) interacts with oxygen availability in the hyporheic environment to determine survival. The oxygen demand of embryos depends on a combination of metabolic rate and respiring mass which is influenced by embryonic stage and water temperature. From Malcolm et al., 2005.

While the survival of developing embryos can be directly affected by the hyporheic conditions, sub-lethal effects can also be apparent under conditions of reduced oxygen availability. These sub-lethal effects, which cause affected fish to be smaller and lighter, can influence the longer term survival after emergence from the gravel into the stream channel (Alderdice et al., 1958; Silver et al., 1963; Shumway et al., 1964; Youngson et al., 2005).

A significant amount of research has examined the importance of sediment composition in regulating the intragravel conditions and hence the survival and

development of salmonid embryos (Sear and DeVries, 2008). Of particular interest has been the issue of fine sediment intrusion associated with bank/soil erosion and land management processes. Fine sediments from exposed soils can easily erode and wash into rivers, where they can infiltrate the gravel and restrict the flow of water and supply of oxygen through the gravel to the developing embryos. Extensive reviews of this subject have been published by Everest et al. (1987) and Chapman (1988). However, this very strong emphasis on fine sediment has caused research to be narrowly focussed onto this one subject to the exclusion of other relevant processes and has only considered the permeability of the gravel in relation to surface water (Malcolm et al., 2008). This emphasis has led to the development of the Sediment Intrusion and Dissolved Oxygen (SIDO) management model (Alonso et al., 1996), which describes only one part of the complex intragravel processes, and to the proposal of relatively simplistic threshold targets for fine sediments (Naden et al., 2002). In effect, the flow and quality of water in the intragravel, hyporheic zone are affected by a range of interacting and dynamic processes, summarised in Figure 7.2 (Malcolm et al., 2005, and these are likely to vary both spatially and temporally. The dangers associated with an over simplistic assessment of spawning habitat quality are clearly demonstrated by the paired research papers produced by Groves and Chandler (2005) and Hanrahan et al., (2005) which indicated favourable spawning conditions based on the assessment of substrate characteristics, but poor habitat based on assessments of hyporheic water quality, reflecting local groundwater and surface water interactions.

The physicochemical conditions in the hyporheic zone vary both spatially and temporally (Malcolm et al., 2003b), and are influenced by the sedimentary characteristics of the stream bed substrate, the in situ biochemical processes and the relative contributions of the surface- and ground-waters that themselves can exhibit marked physicochemical differences (Malcolm et al. 2008). Flow path and residence time both control the chemical composition of different waters by determining the type of soils and geology that the water comes into contact with and by determining the length of time that the water is in contact with those soils and geology. Of particular importance for developing salmonid embryos is the length of time that the surface or groundwater has resided within the soils or geology. For example, surface water exchange driven by turbulence near the bed or by local bedforms (such as bars or riffles) can have a relatively short residence time within the gravel ranging from seconds to hours or days, and as a consequence the water quality may be relatively unaltered from surface conditions. However, groundwater may remain within the soils and geology for years, decades or even longer. Broadly speaking, for areas with organic soils, the longer the residence time of the water, the more oxygen-depleted it is likely to be.

7.5.1 Dissolved Oxygen

The supply of dissolved oxygen to the developing embryos throughout the incubation period is critical for their survival and development. Below critical dissolved oxygen concentrations embryo mortality can be extensive, but even at sub-lethal levels, development can be retarded and deformities occur, and the hatching and emergence of the young fish into the open stream can also be delayed (Alderdice et al., 1958; Silver et al., 1963; Shumway et al., 1964; Youngson et al., 2005). Alderdice et al. (1958) also observed premature hatching and emergence when embryos were exposed to low dissolved oxygen near to their hatch time. A summary of published lab and field measurements of critical mean dissolved oxygen concentrations for developing salmonid embryos is given in 7.1. Notably the reported lab-based measurements are markedly lower than the field-based measurements, perhaps reflecting a greater complexity of processes affecting embryo survival in the natural

environment, but also reflecting the difficulties of adequately characterising dissolved oxygen conditions beneath the streambed (Malcolm et al., 2006). The lab-based studies reported by Alderdice et al. (1958) demonstrated that chum salmon (*Oncorhynchus keta*) embryos could tolerate relatively short periods – up to 7 days – of exposure to very low dissolved oxygen levels of less than 2mg O₂. per litre without any noticeable effects, but pointed out that this level of tolerance depended on the temperature and the stage of development.

Table 7.1 Observed critical mean dissolved oxygen concentrations during embryo incubation for various salmonids, from lab and field based studies.

Species	Critical mean DO (mg O ₂ .l ⁻¹)	Lab/Field	Source
Steelhead (<i>Oncorhynchus mykiss</i>)	1.4	Lab	Silver et al., 1963
	4.3	Field	Sowden and Power, 1985
	7.7	Field	Phillips and Campbell, 1962 (cited in Silver et al., 1963)
Chinook (<i>O. tshawytscha</i>)	1.4	Lab	Silver et al., 1963
Coho (<i>O. kisutch</i>)	7.7	Field	Phillips and Campbell, 1962 (cited in Silver et al., 1963)
Brown trout (<i>Salmo trutta</i>)	6.9	Field	Ingendahl, 2001
	8.0	Field	Hartmann, 1988 (cited in Ingendahl, 2001)
	9.9	Field	Rubin and Glimsater, 1996
	7.6	Field	Malcolm et al., 2003a
Atlantic salmon (<i>S. salar</i>)	7.6	Field	Malcolm et al., 2003a

7.5.2 Temperature

Temperature is an important determinant of both the rate of embryo development and their oxygen requirements (Crisp 1988; Elliott and Hurley 1998). Oxygen demand increases with increasing temperature, and also with the stage and rate of development (Alderdice et al. 1958). Predictive models have been developed to relate temperature to embryo development and timing of hatching and emergence under saturated dissolved oxygen conditions (Crisp, 1988; 1990; Elliot and Hurley, 1998). However, as discussed previously, low dissolved oxygen conditions can influence embryo development and timing of emergence. Given the variation of natural processes, and the possibility of low dissolved oxygen conditions occurring in the natural environment, such simplistic temperature models should be used with caution. Deviation of observed emergence time from a temperature-based prediction, may be a valuable, if simplistic, indicator of dissolved oxygen related stresses in the hyporheic zone. This would however require that the temperature is recorded from the egg pocket or hyporheic zone as opposed to surface water, as temperature may vary between these two environments (Malcolm et al 2004).

7.5.3 Intragravel water velocities

The water velocities within the gravel matrix influence the delivery of oxygen and removal of wastes from the developing embryos. These intragravel velocities are in turn affected by differences in hydraulic head and the porosity of the gravel matrix which itself is a function of the fines content, local hydraulic conditions and stream gradient. The gradient of the streambed is unlikely to change during the embryo incubation period, however the redd itself does gradually flatten out and this change of

profile is likely to reduce water exchange through the redd gravel during the incubation period. The fines content of the gravel redd also changes during the incubation period. When the redd is initially created, it is relatively free of fines – these being flushed out of the gravel by the mechanical sorting action of the redd construction process and the flow of the stream. During the incubation period, fines are likely to re-infiltrate this relatively porous matrix, with the degree of re-infiltration being influenced by geology, soils, gradients, catchment land-use and precipitation/flow (Gibbins et al., 2008, Sear et al., 2008a,b). Intragravel water velocities may therefore also impact on the survival and development of embryos (Rubin and Glimsater, 1996), although these effects have often been considered to be secondary to that of fines content/dissolved oxygen delivery (Lapointe et al., 2004). Sowden and Power (1985), reported that the effect of interstitial velocity became important only above critical dissolved oxygen levels of around 5.3 mg O₂ per litre. In laboratory experiments, Lapointe et al (2004) observed that there was no single threshold intragravel flow velocity that ensured a high level of embryo survival; fines content also matters – particularly the content of sand (0.06 to 2 mm) and especially silt (<0.06 mm).

In general, given suitably high dissolved oxygen conditions, increasing interstitial velocity appears to increase embryo survival, rate of development, and the size of emergent fish (Coble, 1961; Silver et al., 1963; Shumway et al., 1964; Hamor and Garside, 1976; Rubin and Glimsater, 1996). High interstitial velocities coinciding with low dissolved oxygen conditions can still result in high embryo mortality.

7.5.4 Effect of fine sediment infiltration on embryo survival

Fine sediment infiltration (typically considered to be sediments with a particle size less than 4mm, see Sear et al., 2008a) and the consequent reductions in intragravel water velocities and dissolved oxygen delivery, is widely acknowledged to be one of the most significant factors affecting embryo survival and development (Malcolm et al., 2008). The infiltration of fine sediments can affect embryo survival through four main processes that can occur in isolation, or in any combination:

- by reducing interstitial water velocity, therefore increasing the residence time of the hyporheic water and consequently reducing dissolved oxygen delivery
- infiltrated material can have an oxygen demand of its own which reduces dissolved oxygen delivery to the embryos
- physical capping of redds by a layer of fine sediment can cause the entombment of the embryos preventing their natural escape from the gravel
- direct smothering effects on embryos.

Most studies have correlated embryo survival with simple granular metrics which describe the composition of the incubating gravel environment (Lapointe et al., 2004, Malcolm et al., 2008). Lapointe et al. (2004) examined the relationship between embryo survival and various combinations of sand and silt contents in relation to differing hydraulic gradients in the laboratory. For the range of gravel mixtures examined, high silt loadings were seen to be detrimental to embryo survival for all substrate mixtures except those that had a very low sand content (<5 %). For sand contents over 10 %, an increment of 1 % silt had over three times the effect on embryo survival as a 1 % increment in sand.

Unfortunately, such simple metrics fail to recognise the complexity of factors affecting developing embryos and do not address the actual mechanism of how fine sediment infiltration affects embryo survival and development. Therefore they cannot easily be transferred between locations. For example, in a series of field experiments conducted

in a range of river types in England and Wales, Greig (2004) found that simple granular metrics describing the gravel environment were poor descriptors of embryo survival.

To further examine the processes affecting egg survival, Greig (2004) examined the oxygen demand of the sediments that would typically infiltrate the redd gravels, the relationships between intragravel water velocities in artificial redds and four metrics describing the gravel composition. Sediment baskets were used to obtain sediment samples for determining the oxygen demand of the sediments comprising the incubating redd environment. The oxygen demand values varied within and between sites and over time, probably resulting from variations in the age and composition of materials deposited in the riverbed, since the oxygen demand of infiltrated material declines with time. Greig (2004) also noted that the samples recording higher oxygen demand were associated with recent high-flow deposition events, although these effects tended to be relatively short lived, indicating that the organic sediments are quickly metabolised and also implying that the timing of sampling is important for correct identification of dissolved oxygen sags. Of the four granular descriptors that were compared against intragravel water velocities (percentage of fine sediment less than 4mm, percentage of fine sediment less than 1mm, the geometric mean particle diameter, and the median particle diameter (D50)) all were significantly correlated with intragravel flow at all sampling locations, with the exception of the median particle diameter descriptor. Particle size analysis may therefore provide an indication of intragravel water velocities, but not necessarily dissolved oxygen content.

7.5.5 Spatial scale of surfacewater/groundwater interactions

7.5.5.1 *Redd Scale*

Malcolm et al. (2006) were the first to use new dissolved oxygen sensing technology to obtain long-term, high resolution dissolved oxygen data directly from the intragravel environment throughout the embryo incubation period. Using a combination of logging optodes and continuous hydraulic head data, groundwater–surface water interactions and hyporheic water quality were found to vary as markedly at the scale of individual redds as they had at larger spatial scales. Furthermore, temporal variation at individual hydrological event scales was found to be as variable as that found at seasonal scales (Malcolm et al., 2006).

Malcolm et al. (2006) installed high resolution logging optodes in surfacewater and at depths of 0.15 and 0.30 m beneath the streambed in a simulated redd in an intensively used salmon spawning riffle. Dissolved oxygen concentrations in surface water and shallow hyporheic water (0.15 m) were consistently high throughout the incubation period studied, and were seen to vary between 90 % and 100 % saturation in response to diel patterns of photosynthesis and respiration (Figure 7.3). Dissolved oxygen in hyporheic water at 0.3 m depth initially exhibited similar patterns to surface water but, in early January, began to show marked reductions in response to hydrological events. Hydraulic head data collected at the site showed that periods of low dissolved oxygen were associated with a streamward hyporheic flux following catchment rewetting (Malcolm et al., 2006). Low dissolved oxygen periods were particularly associated with the recession limb of hydrological events, when high water table elevation relative to stream stage appeared to cause a streamward flux of groundwater to enter the hyporheic zone. Subsequent analysis, using random resampling of the high-resolution dissolved oxygen data at specified frequencies showed that conventional low-frequency sampling approaches (e.g. monthly) would have failed to capture most of the temporal variability in hyporheic conditions and, in particular, were likely to have grossly underestimated minimum values (Malcolm et al., 2006). These findings identify

the possible limitations of past studies of in-redd survival and identified a potentially major source of error, which may explain observed differences in embryo tolerance to low dissolved oxygen between field and laboratory studies. The probable cause being that short-term changes in dissolved oxygen are not captured by low-frequency sampling used in most field studies.

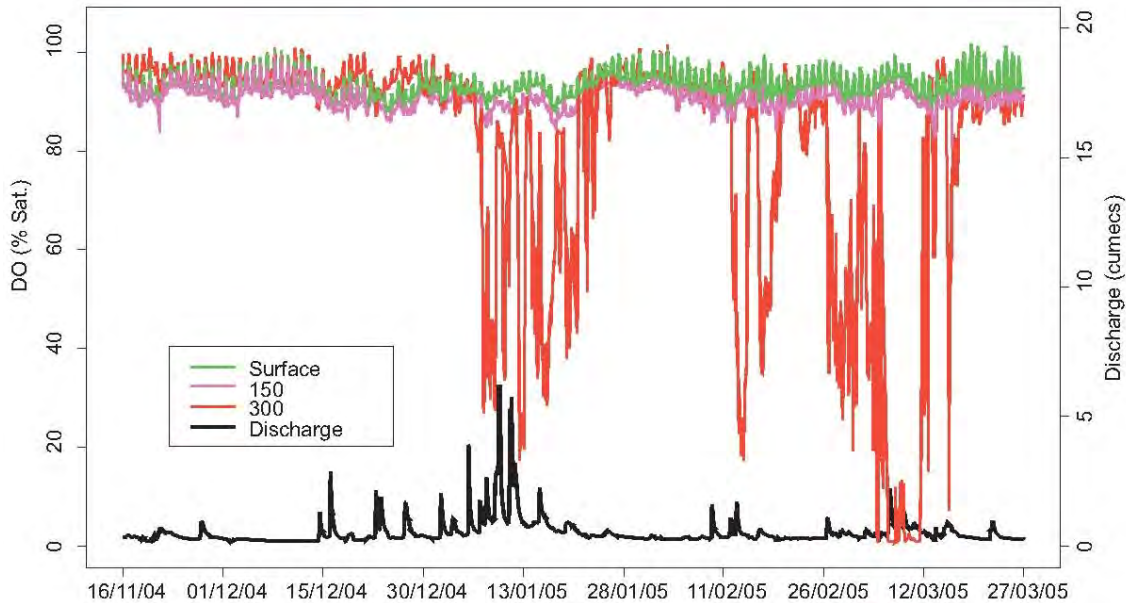

Figure 7.3 Dissolved oxygen concentrations in the stream and hyporheic zone (150 and 300 mm). Discharge data are shown on the secondary y-axis (after Malcolm et al., 2006).

7.5.5.2 *Reach Scale*

In order to examine spatial and temporal variation in hyporheic water chemistry and embryo performance across a spawning riffle, Malcolm et al. (2004) instrumented the most heavily used spawning riffle in the Girnock Burn, a tributary of the River Dee in North East Scotland. Nests of logging piezometers were installed at the head, run, and tail of the riffle to characterise the spatial and temporal variability of hydraulic head and water temperature across the riffle, and artificial redds containing incubation chambers and hyporheic samplers were installed at three locations moving progressively down through the run of the spawning riffle.

Source water provenance within the hyporheic zone was identified by hydrochemical and temperature data, while the direction of hyporheic water movement was indicated by hydraulic head data. The piezometer samples identified substantial groundwater influence upstream of the riffle crest and at the tail of the riffle, through the characteristic low diel variability in temperature depth profiles of the hyporheic water. Increasing surfacewater influence was identified through the run of the riffle, below the riffle crest, in the area of accelerating flow and decreasing water depth.

Hydrochemical data from the artificial redds was generally consistent with the temperature profile data, with the upstream artificial redd in the run of the riffle showing the highest dissolved oxygen and the lowest alkalinity values, again indicative of strong surfacewater influence and short residence times. The middle and downstream redds were characterised by progressively higher alkalinities and lower dissolved oxygen levels, indicating the increasing groundwater influence towards the tail of the riffle. All

three redds were characterised by lower dissolved oxygen concentrations at depth, but the middle and downstream redds differed from the upstream redd in showing marked temporal variability associated with prevailing hydrological conditions.

In general, dissolved oxygen increased during periods of high base flow and declined during periods of low base flow. Extreme low dissolved oxygen values were observed in response to icing events, and unusual patterns of variability were observed when sampling coincided with hydrological events. Of the three redds included in the study, embryo survival was observed only at the upstream redd, but even here, high embryo mortality was observed at 0.3 m depth (Malcolm et al. 2004). Hydraulic head data confirmed upwelling (streamward) hydraulic gradients upstream of the riffle crest and towards the tail of the riffle, but no dominant direction of exchange was identified through the run of the riffle. The high resolution data also revealed that hydraulic gradients changed rapidly during hydrological events.

Prior to a hydrological event, the hydraulic head in the upstream piezometer nest was seen to increase with depth into the streambed, indicating an upwelling, or streamward flux of water. During the peak of the flow, hydraulic head at the various depths converged, indicating temporary cessation of upwelling. Positive heads were re-established on the recession limb of the flood. Piezometer samples from the run of the riffle showed that hydraulic gradients were reversed during peak discharge, indicating that surface water was being forced into the stream bed. These patterns of variability indicated rapid and dynamic responses to changes in stream stage and water table elevation. High water table elevations relative to stream stage drive positive (upwelling) hydraulic gradients during low-flow conditions, while high stream stage during hydrological events generates negative hydraulic gradients (downwelling).

7.5.5.3 Catchment Scale

Malcolm et al. (2005) deployed hyporheic water samplers throughout the main salmon spawning areas of the Girnock Burn, a tributary of the River Dee in North East Scotland, in order to examine the catchment scale variation in surfacewater/groundwater interactions in a significant salmon spawning catchment. Stream and hyporheic water samples were collected from each site at approximately fortnightly intervals (Malcolm et al., 2005; Youngson et al., 2004). Alkalinity and dissolved oxygen were used to differentiate between surface water and groundwater in the hyporheic environment, groundwater being typified by relatively high alkalinity and low dissolved oxygen, and conversely, surfacewater being typified by relatively low alkalinity and high dissolved oxygen. Based on the temporal variability of stream and hyporheic water chemistry, three broad categories of spawning site were identified, reflecting local stream–aquifer interactions (Malcolm et al., 2005). These were groundwater-dominated sites, surfacewater-dominated sites and sites exhibiting transient water table features. Interestingly, those sites that were characterised by the greatest level of groundwater input and lowest levels of embryo survival (Youngson et al., 2004) were located in the two spawning reaches in the catchment with the most consistent and intensive record of historical use by spawning salmon. These particular sites were distinguished from other locations in being located immediately upstream of major transverse valley moraine features comprising poorly sorted material of low permeability. These valley constrictions reduce channel gradients upstream and promote favourable sedimentary and hydraulic conditions for spawning. However, it appears that they also channel down-valley groundwater movement towards the stream and, consequently, lower the local quality of hyporheic water.

Geist and Dauble (1998) observed that Chinook salmon (*Oncorhynchus tshawytscha*) actually seemed to favour areas of upwelling hyporheic water on which to spawn, in the

study reach of the Columbia River, but noted that the stream bed was relatively permeable and hence the hyporheic water was dominated by short-residence surface water rather than long-residence, low dissolved oxygen groundwater.

7.5.6 Temporal Scale of surfacewater/groundwater interactions

Using continuous logging sensors, Malcolm et al. (2009) compared the surface water and groundwater interactions at two salmon spawning sites in the Gironck Burn – one site known to be dominated by groundwater and the other site known to be dominated by surface water.

At the groundwater-dominated site, hyporheic dissolved oxygen concentrations were seen to change rapidly in response to changing hydrological conditions. Low volume (25 ml) spot samples revealed fine-scale spatial variability (<0.05 m) consistent with a vertically shifting boundary layer between source waters. At a surfacewater-dominated location, hyporheic water was typically characterised by high dissolved oxygen and electrical conductivity values, characteristic of surfacewater. Small reductions in dissolved oxygen at this site are hypothesised to be associated with short residence hyporheic discharge.

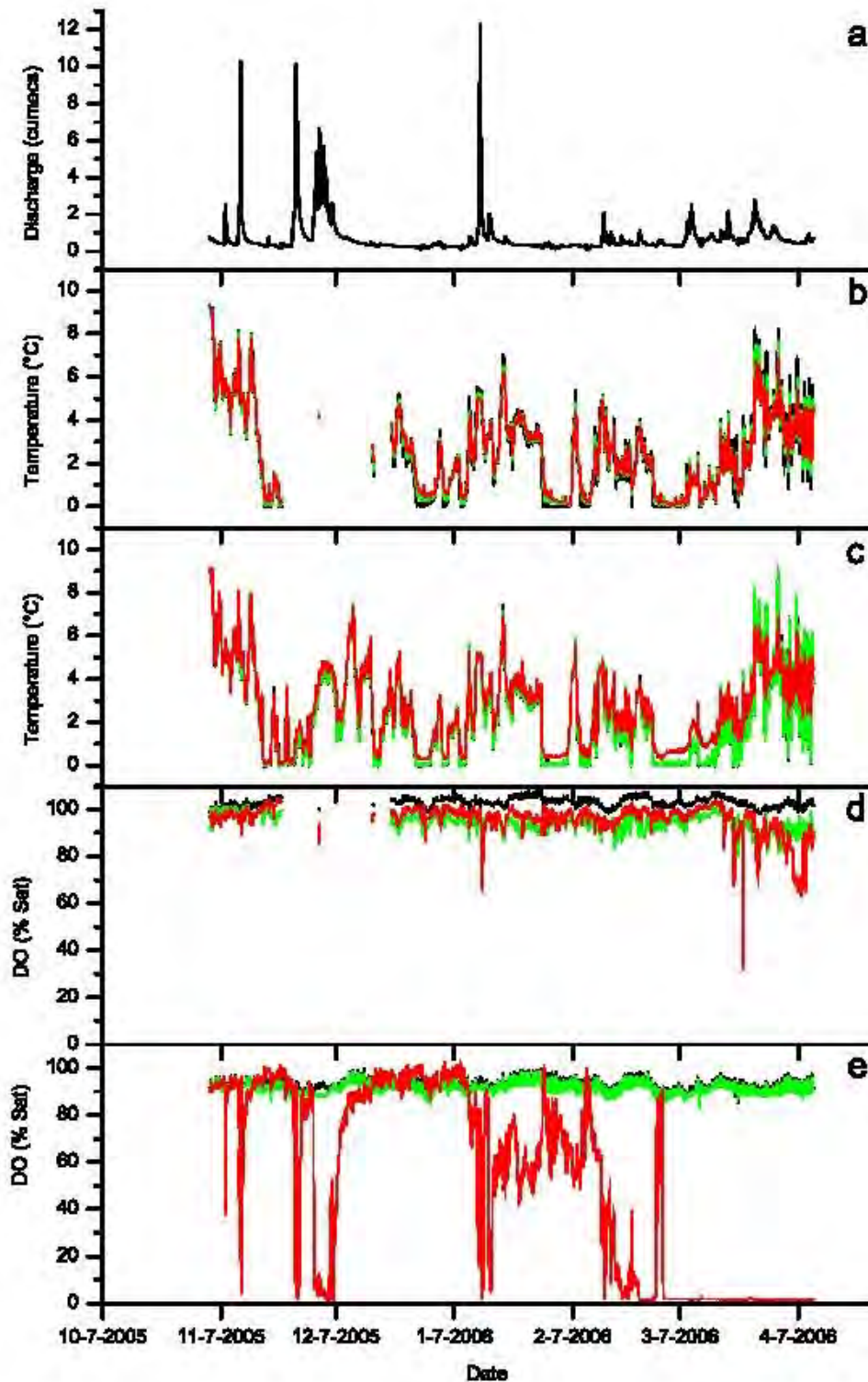

Figure 7.4 A Girnock Burn discharge; temperature at (b) S16 and (c) S7; and dissolved oxygen at (d) S16 and (e) S7, for the period between salmon spawning and embryo hatch. Black lines show surface water, green lines show hyporheic water at 150 mm, red lines show hyporheic water at 250 mm. (From Malcolm et al., 2009).

7.5.7 The effect of hyporheic water quality on embryo survival and development

Youngson et al. (2004) examined the link between surfacewater/groundwater interactions and salmon egg survival and development using vertically stratified egg incubators in artificial redds with nearby hyporheic water samplers. The artificial redds were constructed within known salmon spawning areas that were influenced by variable extents of groundwater intrusion. The effective egg burial depths within these vertical incubators ranged from 0.05 to 0.3 m. Control groups of eggs were located nearby in stream water. None of the control group of eggs died during the incubation period, whereas variable mortality was apparent in the vertical incubators (Table 8.2). High mortalities at the shallowest burial depth at six of the sites were attributed to the eggs experiencing mechanical shock during spates during early development stages. Complete mortality was observed at the deepest burial depth at three of the study sites where low dissolved oxygen conditions associated with groundwater intrusion were observed. Groundwater intrusion was most evident at site 7, and this was associated with complete mortality of all but the shallowest eggs.

Table 7.2. Percent survival within groups of 20 ova, observed at excavation. (Youngson et al., 2004).

Incubation depth (mm)	Location code number									
	2	3	4	6	7	9	10	12	13	16
50	0	0	100	65	100	0	0	100	0	0
100	100	95	100	100	0	95	100	100	100	100
150	100	95	100	100	0	100	100	100	100	100
200	100	100	100	100	0	100	100	100	100	100
250	100	95	90	100	0	100	100	95	100	100
300	100	95	100	0	0	95	100	100	0	100

Those eggs that were recovered from the incubators alive were transferred to a holding facility fed by surface water until they hatched, when they were weighed and measured to assess their condition. The group mean body length of surviving alevins from 0.25m depth was significantly correlated with both the mean and minimum recorded dissolved oxygen from the hyporheic water samples extracted from 0.2 to 0.3m depth (Figure 7.5).

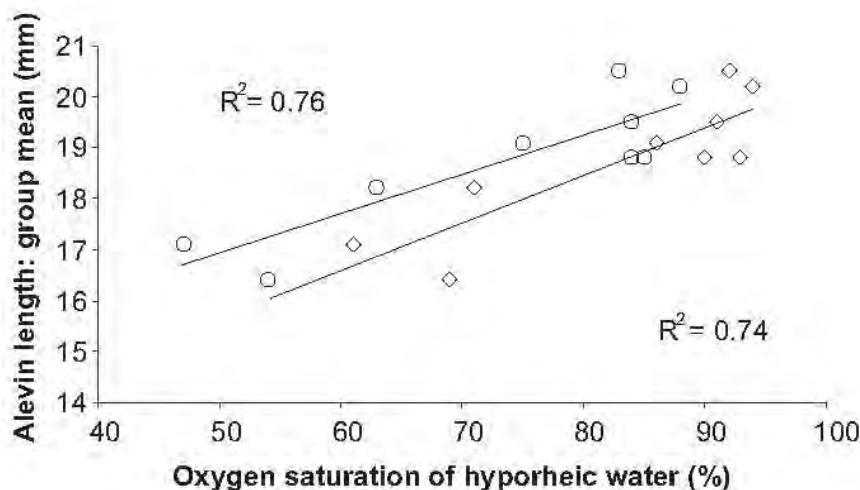

Figure 7.5 Mean alevin length (± 95 % confidence intervals) for the nine surviving ova groups incubated at 250 mm below streambed level. The relationships between length and the mean (○) and minimum (◇) observed oxygen saturation levels are indicated (after Youngson et al., 2004).

7.6 Research needs

A significant amount of research has examined the factors affecting salmonid embryo survival and development during the intra-gravel incubation period in the hyporheic zone, but this has rarely included examination of the importance of groundwater, particularly long residence, low dissolved oxygen groundwater. Low dissolved oxygen groundwater is a natural feature of the hyporheic zone, and its influence on salmonid spawning gravels has been shown to vary spatially and temporally. However its extent and influence on developing salmonid embryos is not easy to predict or evaluate without direct high resolution or well targeted measurement.

In situ measurements of the hyporheic incubating environment and its effects on embryo performance need to take proper account of the impact of the groundwater and surface water interactions.

There have been significant developments in environmental monitoring of hyporheic water quality for salmonids that allows researchers to assess the timing frequency and magnitude of low dissolved oxygen episodes. However, there remains uncertainty as to critical dissolved oxygen concentrations and durations for salmonid embryos at different stages of development. While evidence suggests that salmonid embryos can endure short periods of very low dissolved oxygen, the interaction between developmental stage, dissolved oxygen concentration and exposure time deserves further investigation. This would allow improved predictions of spawning success and help inform management decisions.

The extent of impact of low dissolved oxygen groundwater on the incubating embryos of gravel-surface spawning fish species is likely to be lower than that on salmonids, but this may still be worthy of directed research.

Dissolved oxygen is just one important feature of groundwater quality with respect to fish embryo survival and development. The chemical quality of groundwater also needs to be considered in assessing ecological impacts, particularly with respect to the effects of anthropogenic impacts on groundwater quality.

Some observations, primarily from North America, suggest that upwelling groundwater provides valuable cool refugia for free-living coldwater species during warm, low flow periods. Such refugia could potentially become more important for coldwater species as climate change causes river water temperatures to rise in the future. This is particularly relevant as the southern rivers of the British Isles, where climate impacts are likely to be most pronounced, lie towards the southern extent of the native range of salmon and trout.

7.7 Recommendations for management

Significant effort is increasingly being directed towards the improvement of salmonid spawning habitats and the associated management of land and riparian corridors to reduce fine sediment inputs. While these efforts will undoubtedly improve the quality of spawning gravels in the longer term, it must be recognised that low dissolved oxygen groundwater will continue to impact embryo survival and development where it is a prominent feature of the hyporheic zone.

Where efforts are made to improve or create new spawning habitat, local hyporheic water quality and groundwater-surface water interactions should be examined. It is important to ensure that managers are not encouraging fish to spawn in superficially appealing locations that offer poor spawning success.

Finally, where it can be demonstrated that embryo survival is limiting to local populations (regardless of cause), managers may wish to consider the use of hatcheries or in-stream incubators to minimise over winter mortality of native stocks.

7.8 Conclusions

The hyporheic zone is subject to complex interacting processes that can affect the survival and development of salmon and trout embryos during their over-winter incubation period. Free-swimming life stages of freshwater fish, and those species that lay their eggs at shallow depth or on the gravel surface, are likely to be relatively unaffected by hyporheic zone conditions and processes.

The delivery of oxygen to incubating embryos is one of the critical factors affecting their survival development. Within the hyporheic zone dissolved oxygen delivery is affected by the infiltration of fine sediment into the gravel, the sediment oxygen demand and interactions between surface-water and groundwater. Surface water is typically high in dissolved oxygen, while groundwater, particularly long-residence groundwater, is typically low in dissolved oxygen. Surface water and groundwater interactions vary both spatially and temporally, and their relative extents and influences cannot be readily evaluated or predicted without direct field measurement.

8 Measurements and monitoring at the groundwater-surface water interface

8.1 Summary of key messages

1. *Holistic and interdisciplinary approaches.* Recent legislations, such as the European Water Framework Directive, have put the emphasis on groundwater-surface water interactions and their impact on the ecological status of streams. Stressing the importance of groundwater-surface interfaces (GSIs) may also favour, for example, better risk assessments in the context of remediation of groundwater contamination. These new approaches impose to:
 - consider interactions between water bodies which have been traditionally monitored separately
 - monitor hydrological and hydrochemical fluxes and biological parameters in an integrated manner.
2. *Spatial and temporal scales.* Characteristics of local GSIs are typically controlled by biotic and abiotic processes at larger scales. This range of scales can be wide, both in time and space. In terms of GSI monitoring, this implies:
 - accounting for large scale processes before focusing on small scale heterogeneity, for example by assessing the main direction and intensity of flow, as well as the broad hydrochemical and biological features of an area before collecting point data.
 - accounting for the scale of temporal variations associated with a given system; for example, groundwater flow in a porous media may be more stable than river stage variations.
3. *Available datasets and field observations.* Hydrological, hydrochemical or biological data are often collected by national agencies or private companies. These datasets, in conjunction with the use of hydrogeological, geological or land-use maps are essential to design any monitoring strategy.
4. *Field data collection.* A large range of tools and methodologies traditionally used in streams and aquifers can be applied to the study of GSIs. Among the more specific techniques some have been tested while others are still in development, especially for monitoring the riverbed environment.
 - Considering the simultaneous collection of hydrological, hydrochemical and biological data is critical in designing a monitoring strategy.
 - Dealing with heterogeneity in space and time may benefit from the joint use of: (1) point methods; (2) average-based methods (which integrate spatial or temporal variations); or (3) “distributed” methods (which, to the contrary, provide insight into spatial or temporal variations).
 - Recent technologies, such as automatic remote loggers or sampling devices can facilitate the monitoring and reduce costs.

5. *Categories of methods.* For monitoring biological, chemical and hydrological parameters of GW/SW interfaces, the following classes of methods are available:
- Wells, piezometers and sampling pits
 - Coring methods (e.g. auger, freeze coring)
 - Seepage meters
 - Stream flow measurements
 - Hydrographic analysis
 - Infrared photography
 - Artificial and environmental tracers
 - Temperature as a tracer
 - Geophysics
 - Microcosms, experimental chambers, and colonization chambers
 - Hydrochemical measurement probes and samplers
 - Biological sampling methods of subsurface fauna

8.2 Introduction

Appropriate and cost-effective monitoring of the status of water bodies is critical to identify pressures on natural systems and inform decision-making. Designing a monitoring strategy certainly demands a good knowledge of the equipment and procedures. In the field of groundwater and stream water (GW/SW) interactions, practitioners and researchers have to develop these skills for both groundwater and surface water bodies, and in a variety of environments, such as open streams, deep aquifers, riparian zones or riverbed sediments. Furthermore, the assessment and understanding of key biotic and abiotic processes has to cross disciplines such as biology, chemistry, geology, geomorphology, hydrogeology and hydrology.

While the present handbook provides a general introduction to the science of GW/SW interactions, this review starts by discussing potential objectives and strategies of a monitoring programme. This part is followed by implementation considerations, which present a range of methods and tools designed to assess flow, solute, and biological characteristics at the GW/SW interface.

8.3 Designing a monitoring programme

8.3.1 Why is the monitoring undertaken?

A sound understanding of the environmental issue at stake and of the impacted area are critical in selecting an appropriate monitoring approach, in assessing the required financial and labour resources, as well as in identifying issues of access to rivers or private lands. Below we present common issues and objectives that create a need for monitoring GW/SW interactions. In a synoptic view (Table 8.1), these are further linked to specific methods.

8.3.1.1 *Hydrological studies*

In the context of GW/SW interactions, studies focusing on quantitative aspects aim at estimating net fluxes of water exchange between water bodies, for example to make flood predictions or to develop riverbank filtration schemes. From this perspective, it is common to be interested in the aquifer's average permeability or the net change of stream discharge over a given reach (Chapter 9).

When dealing with biological or hydrochemical issues, an accurate description of the flow field, and of the distribution and timing of GW/SW interactions, are essential to untangle the complexity of the processes (Chapters 5 & 6). Matters of interest may be the degree of connection between the stream and the aquifer, the distinction between waters of different age and origin, or the change of flow direction between the two water bodies - can one contaminate the other?

8.3.1.2 *Hydrochemical studies*

A major environmental concern is the transport and fate of nutrients and contaminants at the GW/SW interface. Not only does this interface create a connection between the two water bodies, but it can also modify concentrations through dilution, water-rock interactions, microbiological processes or uptake of solutes by the vegetation (Chapters 5 & 6).

In a first stage, monitoring programs seek to relate the distribution of nutrients or contaminants to the spatial extension and temporal dynamic of the flow field. Further hydrological and sedimentological campaigns may help improving estimation of flow direction and transit time, and therefore rates of attenuation or release of solutes at the interface. This work can ultimately lead to the calculation of mass balances and budgets, and to the calibration of solute transport models (Chapter 9).

8.3.1.3 *Biological studies*

The effect of GW/SW interactions on stream biotic communities is of major concern for water resources and land use management. Yet the complexity of the processes involved makes it difficult to assess ecosystem health. Common issues that can be linked to GW/SW interactions are the quality of fish spawning sites, stream biodiversity or eutrophication processes (Chapters 5 & 7).

Assessing the biological quality of aquatic systems generally involves mapping the distribution of organisms. For example, in England and Wales, the Environment Agency monitors the abundance and presence of fish, benthic macroinvertebrates, periphyton and macrophytes to classify river stretches and monitor the impact of human activity. Among other factors, GW/SW interactions are known to influence benthic communities, either directly, such as when nutrient-enriched groundwater discharges into the stream, or through biotic interactions, for example between hyporheic and benthic fauna. It is therefore reasonable to include such processes in ecosystem assessments.

It is anticipated that inclusion of such factors can help constrain biologically focused models, and help to increase the reliability of ecological indicators.

8.3.2 **What data are to be collected?**

The choice of data to collect, and therefore the methods to be applied, depend on the study objective. If the aim is to assess the groundwater contribution to stream flow, a hydrographic analysis may suffice (Chapter 4). If it is to study the effects of discharge of contaminated groundwater on the benthic fauna, then a finer delineation of upwelling and downwelling zones may be needed.

In all cases, particular care must be taken with respect to scale. Hyporheic and riparian environments can be highly heterogeneous, so local measurements may not be representative of the natural system. Therefore it is useful to recognise if a technique is a point or local method; a lumped- or average-based method, which integrates spatial

or temporal variations; or a 'distributed' method, which provides insight into spatial or temporal variations. For example, sampling a piezometer is a local method, differential stream flow gauging provides a lumped result, and continuous records of stream flow contain temporally distributed information. In general, sound monitoring approaches involve the parallel use of several tools, in order to increase the degree of confidence in the results.

If different field sites are to be compared, one should attempt to minimise inter-site variability where it is not wanted. For example, when comparing the fauna of a human-impacted stream with a pristine stream, it is recommended to select reaches of similar characteristics (e.g. water depth, vegetation cover, grain size).

8.4 Implementing a monitoring strategy

A good starting point is to study available datasets and carry out a field exploration. Accordingly, we first discuss the benefits of preliminary studies, before presenting the larger range of field methods that are applicable to the GW/SW interface. These are presented according to the standpoint of the 'observer' in the field: (1) the subsurface; (2) the GW/SW interface; and (3) the stream.

Although the initial aim of a monitoring scheme is unlikely to change, it must be emphasised that the implementation often follows a 'trial-and-error' process. Indeed, in river environments, it is not unusual to discover monitoring devices that have been damaged by high flow conditions, or sampling networks that are too sparse, given the heterogeneity of the field site. Likewise, although some field-measurement devices appear easy to use, it is recommended to be fully trained and to test the apparatus *in situ* prior to collecting data.

8.4.1 Preliminary studies

Examining existing sources of information, through a desk study and field observations, can provide invaluable information that facilitates the selection of methodologies and sampling locations.

8.4.1.1 Desk study

Existing data that can provide useful information about surface and subsurface environments include:

- Topographic maps (geomorphic features, e.g. sinuosity)
- Geological and hydrogeological maps (the type of aquifer, its thickness, boundaries and productivity)
- Groundwater flow nets (general flow direction between streams and groundwater)
- Land use or land cover maps
- Monitoring data from regulating agencies and independent groups (e.g. habitat survey, macrophyte, fish, redds or invertebrate distribution)

8.4.1.2 *Field observations*

In addition to desk studies, a site visit can provide important indications on potential GW/SW interactions. This type of information includes (Brodie et al., 2007):

- Sediment characteristics and river flow types
- Anthropogenic features such as weirs
- Presence of macrophytes and fish redds
- Precipitation of metals oxy-hydroxides or carbonates on the riverbed
- Change of stream water colour or odour in polluted areas
- Springs or visually explicit increase of stream flow
- Differences in temperatures producing vapour at the surface or melting the snow and ice

8.4.2 **Subsurface data collection**

8.4.2.1 *Wells, piezometers and sampling pits*

A *monitoring well* is a permanent or semi-permanent well, fitted with a long screen (section of slotted pipe), which is used to sample groundwater and/or measure the water table elevation. The sampling is *depth-integrated*, i.e., it covers all depth levels; it is commonly used to assess the presence of contaminants in aquifers without expending too much effort on the drilling. A *piezometer* is a small-diameter well with a short screen, used to make head measurements and sample water at a specific depth. *Mini-piezometers* (Figure 8.1) are similar devices, generally of smaller diameter and commonly installed at a maximum of 2m depth (Brodie et al., 2007), either in the floodplain or directly in the channel. There is a variety of piezometer and mini-piezometer designs (e.g. Brodie et al., 2007; Rivett et al., 2008). In general, these devices are installed along transects or over a horizontal plan (network). Installation can be carried out either manually, by augering or hammering (*direct push* methods) (Figure 8.2), or with a powered auger (Brodie et al., 2007). Depth-specific sampling allows for determining the vertical variability of hydrochemistry or biology, and the vertical hydraulic gradient. It can be achieved by the use of: *inflatable packers* (see glossary) in a monitoring well; *nests* of piezometers screened at different depths; *multi-level samplers*, consisting either of multiple piezometers in a single casing or of sampling tubes attached to the exterior of a central tube; or, often in exploration phases, a standpipe temporarily inserted (*point-in-time direct push technique*) at increasing depths. Finally, a *sampling pit* is a hole that is excavated out of the wetted channel, where the water table is shallow enough to be accessed. It is used to rapidly measure water-table elevation and collect sediments, fauna and water samples (Dahm et al., 2006).



Figure 8.1 Network of mini-piezometers (PVC tubes) installed to monitor VHGs and seepage fluxes in the river (photo: Daniel Käser).



Figure 8.2 In-stream mini-piezometer installation on a scaffold tower. A drive-pipe fitted with a removable driving-point is hammered into the riverbed using a fence post-driver; at the required depth, the mini-piezometer is inserted in the drive-pipe, and the latter pull out by keeping the mini-piezometer in place (photo: Tristan Ibrahim).

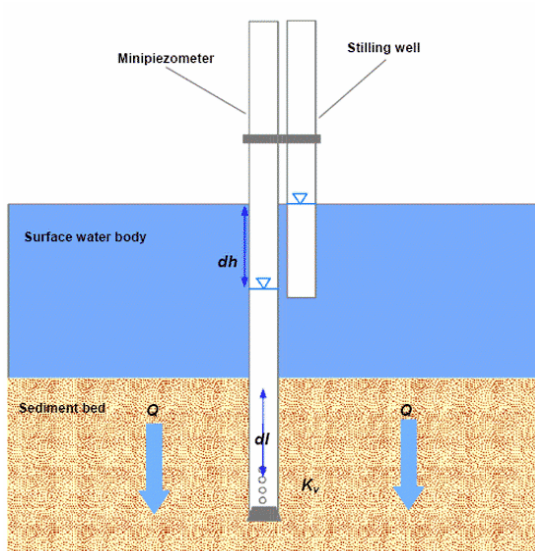

Figure 8.3 Seepage flux measured using a minipiezometer and a stilling well. dh stands as the difference of level between the stream water level and the riverbed water level, and dl the length of piezometer buried in the riverbed. Vertical Hydraulic Gradient equal to dh/dl and the seepage flux is computed using the vertical component of K (K_v). In this case, as the riverbed water level is lower than the stream water level, VHG is negative and the seepage flux orientated downwards. (Source: Australian Government Department of Agriculture, Fisheries and Forestry.)

8.4.2.2 Hydrological fluxes

A hydrological flux can be calculated through Darcy's law if the hydraulic conductivity, K , and the hydraulic gradient (see glossary) between two points are known. Methods for the estimation of K are described in all hydrogeology textbooks, e.g. Fetter (2001). More specific in-stream techniques have been compared in sandy streambeds by Landon et al. (2001). At a large scale (10-100 m), K is commonly estimated by pumping a well at constant rate and measuring the water level variations at close wells (*pumping test*). At a smaller scale (cm-m), K can be determined through a single well *slug test*, where K is related to the time taken by the water level to recover its initial position after an artificial displacement. The second term of Darcy's equation, the hydraulic gradient, is computed from hydraulic heads at a minimum of two points; if these points form a vertical array, the result is the Vertical Hydraulic Gradient (VHG). In-stream VHGs can be obtained by measuring the head difference between the water level in a piezometer and the stream stage. Water levels are typically measured with a *Water level meter*, from the top of a well. A tube, or *stilling well*, is sometimes fixed to the piezometer to reduce the effect of flow turbulences on stage measurements (Figure 8.3). Alternatively the stage can be measured using a vertical graduated marker (*staff gauge*), fixed on the side of the channel. To collect continuous time series, *water level loggers* can be used in permanent wells and piezometers. For temporary VHG estimations, Rosenberry and LaBaugh (2008) provide details on the design of *portable hydraulic manometers*.

8.4.2.3 Hydrochemical sampling

Most techniques used to access the subsurface, such as *wells*, *piezometers*, *direct-push devices* or *sampling pits*, can be used for both hydrological and hydrochemical measurements. Even a small monitoring network can provide valuable insight into the hydrochemistry of the riparian zone and the riverbed. In addition, it can facilitate the design of a denser network, for example to capture the extent of a contaminated plume. *Multi-level samplers* can be used to enhance the vertical resolution of hydrochemical mapping. As to the dynamics of hydrochemical fluxes, it can be monitored by adapting the sampling frequency to hydrological events or seasons. Because capturing events can be a challenging task, *automatic samplers* and *remote sensors* are sometimes used as an alternative to manual sampling (e.g. Quattrocchi et al., 2000). However, maintaining such equipment may be time-consuming.

To characterise a contaminant plume, in terms of average concentration and mass flow rates, a constant pumping can be operated in one or several wells. The pumped water is regularly sampled for chemical analyses, and if additional control wells are sampled downgradient of the contamination's source, attenuation rates may be estimated. Since this approach tends to avoid issues related to the structural heterogeneity of the aquifer, it is called an *integral pumping test* (Kalbus et al., 2006). Durand et al. (2007) discuss the case-study of a long-term pumping test combined with the monitoring of riverbed multi-level mini-piezometers, in order to assess the attenuation of contaminants in the hyporheic zone. In general, for large well networks and in the long-term, such tests are relatively expensive.

8.4.2.4 Biological sampling

One of the most straightforward methods for obtaining invertebrate samples from deep or shallow wells is with a *net sampler* (Schmidt et al., 2004). A small diameter *plankton net* (usually 43 μm mesh size) is lowered into the well until it hits the bottom, at which point the sediment is disturbed and animals and sediment are retrieved. The procedure

is then repeated to specifications. By itself, this is not a quantitative method; it is nevertheless useful for a simple and fast assessment of the subsurface fauna.

In general, sampling subsurface organisms by well pumping involves either using the well as a trap, or purging the water and then sampling the refill (e.g. Hancock and Boulton, 2009). As for hydrochemical sampling, inflatable packers can be used for a better control on the sampling depth.

Whereas (semi-)permanent wells allow the collection of time series at a given location, a *portable standpipe* allows for roaming surveys. The latter approach involves hammering a steel standpipe to a desired depth and pumping out water. Bou & Rouch (1967) described this method using a hand piston-pump (Figure 8.4), that allows for constant perturbation of the substrate during extraction. As the relationship between the number of organisms and sampled volume is not linear, it is usually advisable to collect a standard volume for all samples. The European PASCALIS project standardised their samples to 6 litres (Gibert et al., 2001). However, volumes from 2 litres to 10 litres are not uncommon in the literature. Because wells inherently alter the bed, it can be argued that animals in the riverbed are not sampled, but rather those that are in this altered habitat. Additionally, issues of sample contamination by surface organisms must be considered. One way to avoid contamination is to sample *exposed* - rather than submerged - *sediments* in mid-channel bars or side bars.

Many researchers find the use of the *Karaman-Chappuis pit method* (FreshwaterLife 2009) as used by Boulton et al (2004) to be ideal as it simply involves digging a hole of predetermined dimensions and collecting the animals and water from the pit. As is the case with all subsurface sampling, depth is a critical factor in invertebrate abundance and should be selected and standardised according to the question.

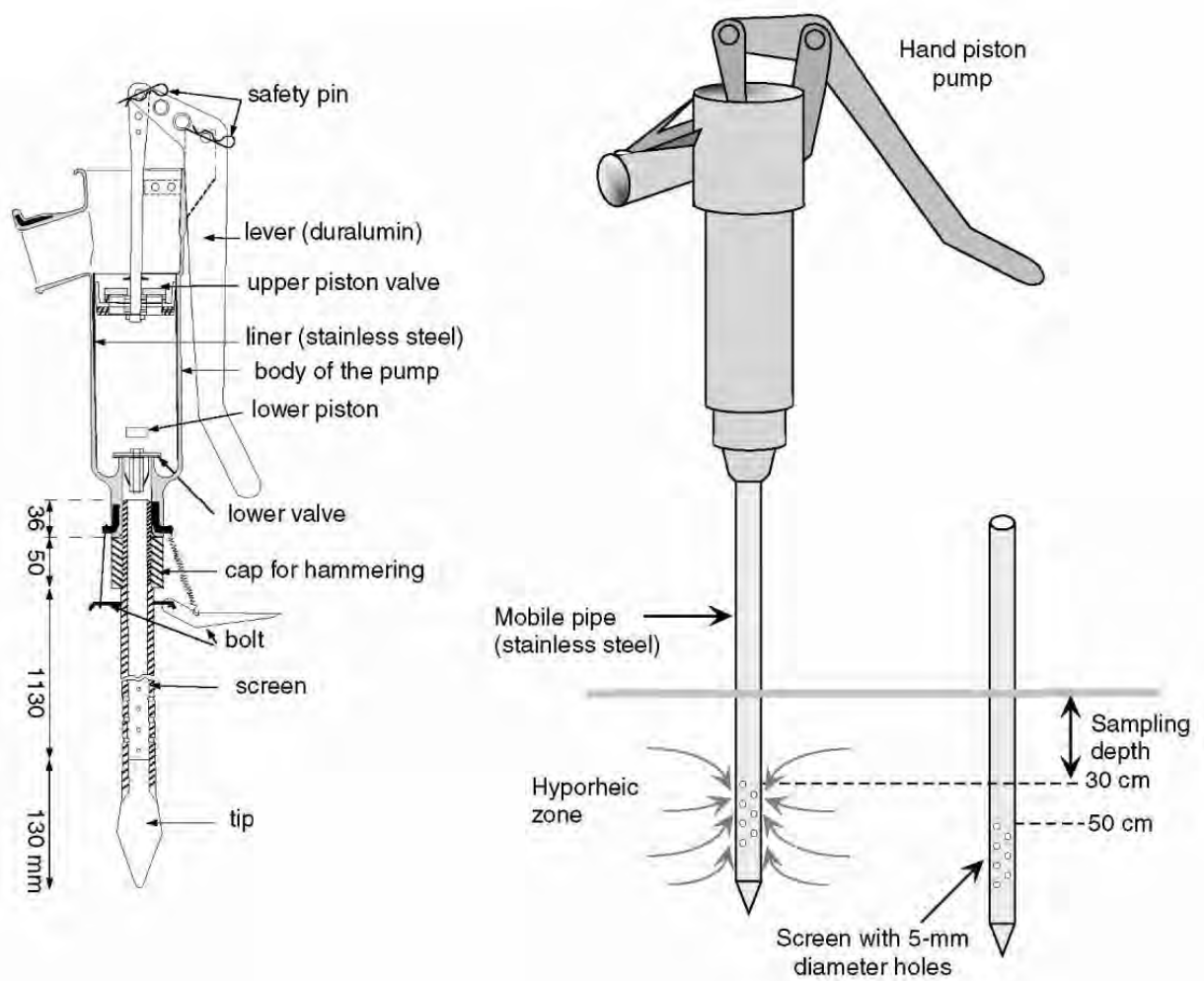

Figure 8.4 Diagram of Bou-Rouch sampler using hand-piston pump. From Gibert et al. (2001).

8.4.2.5 Artificial tracers

Artificial tracers are chemicals or materials that are introduced in the hydrological system for monitoring purposes. *Conservative tracers* are (relatively) inert substances that allow tracking the movement of water; such substances include fluorescent dyes (e.g. Rhodamine WT) and saline solutes (e.g. NaCl, KCl, LiCl). In contrast, *non-conservative tracers*, which tend to react with their environment, can reflect the behaviour of nutrients or contaminants. Various reactive tracers have been used to assess the potential for retardation-transformation near the GW/SW interface. These include nitrates, isotopes or metals. Finally, '*smart tracers*' are a promising approach, still in its development stage; they are defined by Haggerty et al. (2008) as behaving as conservative tracers, but showing "an irreversible change in the presence of a process or condition under investigation". Reactive and conservative tracers are often used in conjunction to track simultaneously hydrological and hydrochemical fluxes.

8.4.2.6 Hydrological applications

In a *well-to-well* test, a tracer is injected into a well and its propagation in the subsurface is monitored through an observation well. If the tracer appears at this second point, the subsurface water velocity can be obtained by dividing the travel time

of the conservative tracer by the distance between the two points (e.g. Pinay et al., 2008).

A variation of this approach, the *stream-to-well test*, is designed to characterise the infiltration of surface water, by injecting the tracer in the stream rather than in the subsurface (e.g. Wondzell, 2006).

A *point-dilution test* provides a measure of subsurface flux where flow is near-horizontal. The procedure involves injecting a tracer in a well, monitoring the dilution caused by subsurface water flowing through the well. The horizontal flux can be calculated with a standard equation – see Freeze and Cherry (1979). If the porosity is known the true velocity of water can be derived as well.

8.4.2.7 *Hydrochemical applications*

Simultaneously injecting a conservative and a reactive tracer is an invaluable tool to assess physical and chemical processes. In principle, any concentration decrease of the conservative tracer indicates dispersion or dilution, whereas changes of the 'reactive:conservative' concentration ratio reflect the intensity of chemical reactions. In general, a contaminant solution that is enriched relative to the background concentration is injected and the ratios are monitored in the subsurface along a natural or forced hydraulic gradient. One drawback is that high solute concentrations are seldom representative of natural conditions.

More expensive is the use of *radiotracer* techniques, in which trace amounts of radionuclides (or labelled atoms) are injected into a water body, and monitored in order to characterise the transport of some elements or compounds. A main advantage is that the injectate can be at background concentration. This type of technique has been used to estimate rates of denitrification or methanogenesis (e.g. Hansenet al., 2001).

Single-well reactive tracer tests are used to assess biogeochemical processes at a specific location. In the *push-pull* method (Addy et al., 2002), both a reactive and a conservative tracer are injected in the subsurface. After an incubation period, part of the solution is recovered by pumping, and then sampled. This method allows for a relatively fast investigation of a great number of sites; it is nevertheless limited by the small volume investigated.

8.4.2.8 *Environmental tracers*

Environmental tracers are chemical or isotopic compounds that either occur naturally or entered the water cycle through human activity. For Brodie et al. (2007) they primarily include standard field parameters (e.g. electrical conductivity), major anions and cations (e.g. Cl⁻), stable isotopes (e.g. ¹⁸O), radioactive isotopes (e.g. ²²²Rn), and industrial chemicals (e.g. CFCs). To this, we add 'heat' since the daily temperature fluctuations of stream water provide a signal for tracing GW-SW exchanges.

Environmental tracers are commonly used to determine source areas of water, the age of water, mixing ratios or water mass balances. They can also be analysed in combination with reactive species, for example to characterise biogeochemical processes. Measurement devices for standard parameters such as pH, dissolved oxygen and electrical conductivity are relatively cheap and easy to use. They can help identify the water types present in a certain area. But for a better understanding of a hydrological system, the water's composition will be more informative. At this point, the availability and cost of analyses may have a significant impact on the choice of a method. For example, whilst the analysis of major ions is performed on a routine basis by many institutions, facilities for isotope and CFCs are not as readily accessible.

The attractiveness of heat as a tracer lies in the relatively low cost of basic probes and loggers (Figure 8.5). The approach relies on the fact that heat is transported by flowing water, and that the daily fluctuation of stream temperature is perceived at greater depth in a losing reach (stream to subsurface flow) than a gaining reach (subsurface to stream flow). In a simple application assuming one-dimensional flow, the flux can be determined at the vicinity of the GW/SW interface using an array of temperature probes, in the horizontal or vertical plan (e.g. meander or streambed, respectively). For more details, see Stonestrom and Constanz (2003).

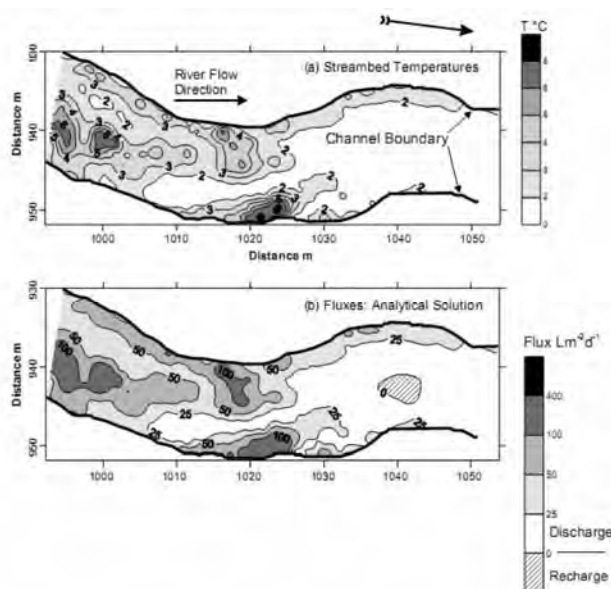

Figure 8.5 Plan-view contour maps of the Pine River (Canada) in winter for mapped streambed temperatures (a) and vertical fluxes using an analytical solution (b). From Schmidt et al., 2007.

8.4.2.9 Coring

Extracting a sediment core permits a combined assessment of physical, chemical and biological properties of the sediments and pore-water. The main drawbacks of coring methods are the poor horizontal resolution, the labour involved and the impossibility of taking repeat measurements at a specific location (Bridge, 2005). A review of the principal methods for coring non-submerged sediments is given by Weight and Sonderegger (2001).

In soft sediments, light hand-held devices are preferred; sometimes plastic tubes can be directly hammered and extracted with their top capped (Figures 8.6 and 8.7), in order to retain the core (e.g. Sheibley et al., 2003). But where the substrate is harder, for example in cobble-bed streams, the use of heavy drilling equipment may be necessary. A variety of drilling tools are available, such as portable electric- and petrol-power auger, or drilling rigs. Freeze-coring (Figure 8.8) is a distinct technique that makes use of a steel tube hammered into the bed, and liquid nitrogen to freeze the sediment before its extraction (e.g. Hill, 1999). Note that, in deep or fast flowing rivers, such heavy tools can be extremely difficult to operate.



Figure 8.6 Hammering of PVC tube for coring of soft riverbed sediments (photo: Nick Riess).



Figure 8.7 Sawing of the core in site (photo: Nick Riess).



Figure 8.8 Ice coring; left: core being extracted; right: frozen core (photo: Andy Quin).

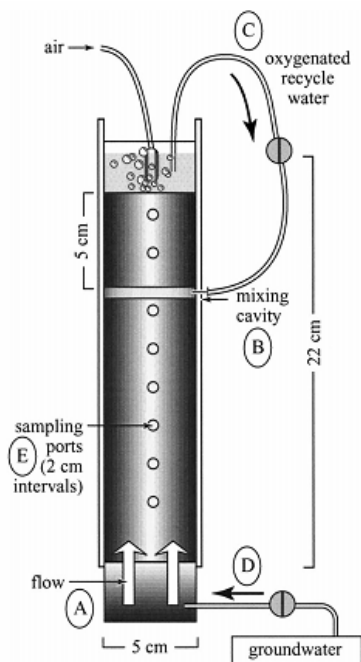

Figure 8.9 Diagram of a perfusion core setup to assess inorganic nitrogen transformations in riverbed sediments. (D) Groundwater is evenly injected through the inlet cup (A) and flow upward in the column (B). A mixing cavity (C) is used to introduce into the column aerated recycled water using a peristaltic pump. Samples are taken from the inlet, outlet and at the sampling ports (E) along the column. From Sheibley (2003).

8.2.2.9.1 Hydrological applications

K can be derived from a core-sample either through *grain size analysis* or a *laboratory permeameter test*. Grain size analysis consists in sieving a sample into different fractions, and applying an empirical relationship relating the proportion of these fractions to hydraulic conductivity. Existing equations have been reviewed by Vukovic and Soro (1992) and Odong (2007). Generally, organic matter is removed prior to sieving (see Schumacher, 2002). Second, the *laboratory permeameter test* involves imposing a hydraulic gradient on an enclosed column of sediment; the hydraulic conductivity is then derived either from the flow at the outlet (*constant head permeameter*) or the rate at which the water level falls after an artificial rise (*falling head permeameter*) (Fetter, 2001).

8.4.2.9.2 Hydrochemical applications

Cores can be used to relate pore-water chemistry to the sediment's geochemistry, and more generally characterise biogeochemical processes. The advantage of *freeze-coring* is that the chemical gradients are preserved, although in practise frozen samples are more difficult to manipulate.

In the laboratory, pore-water is usually extracted by suction, diffusion equilibration, or by squeezing or centrifuging sections of the core (Berg and McGlathery, 2001). The sediment's biogeochemical properties can be assessed by measuring physical and geochemical characteristics, such as the grain-size, fraction of organic carbon (f_{oc}), cation exchange capacity

(CEC) or clay content (e.g. Smith and Lerner, 2008), as well as by studying microbiological communities (Chapter 6).

Alternatively, contaminant-sediment interactions can be studied by mounting an intact core in a laboratory column (*perfusion core*, Figure 8.9). Once a controlled flow is established between its two ends, a solute is injected, and then sampled from the outflow. By comparing the chemical characteristics of the inflow and outflow, it is possible to estimate the vertical transformation rate of a contaminant. In this type of experiment, the operator has control on the water chemistry and solute concentration of the injectate. The apparatus may also allow for water extraction at several sampling ports along the column (see Sheibley et al., 2003).

8.4.2.9.3 Biological applications

Freeze-coring is often said to offer the most direct method for mapping the vertical distribution of biota. Once the core is removed, it is typically sectioned by depth over a trough that is divided into 10-20 cm units. As the core melts, sediment and animals fall into the assigned compartment, which can then be sampled. As a matter of choice, the frozen core can be chipped away from the standpipe at desired intervals and bagged for later processing (Adkins and Winterbourn, 1999). Organisms can be separated from the substrate by decantation: after swirling the sample in a bucket of water and allow it to settle, the decanted material is then run through a sieve of specific mesh size (63-100 μm is common for including meiofauna while larger mesh sizes may be preferable for macrofauna).

Other approaches enable a biological sampling of sediment cores. For example, pushing a tube in the streambed and sectioning the extracted core can provide insight into the movement of subsurface fauna and allow for microbiological sample collection. The use of such coring techniques is generally limited to fine-sediment streambeds or very shallow samples. Drilled cores are not generally used for faunal investigations, because of the mechanical disturbance.

8.4.2.10 Measurements probes and passive samplers

Most sampling devices designed for the aquatic environment can be used specifically at the GW/SW interface – see Bridge (2005) for a review. Besides the widely-used conductivity-, pH-, and redox-meters, various probes are available, among which the *ion-selective electrode*, which measures the activity of specific ions such as ammonium, nitrate, lead, or cadmium. When connected to a logger, it can provide concentration time series. However, if the concern is upon small scale spatial variations, *gel probes*¹ may be an appropriate alternative. These passive samplers either equilibrate with the pore-water chemistry, or accumulate specific chemical elements or compounds. They can provide, after laboratory analyses, concentration profiles at a resolution as fine as a millimetre.

This type of device has the advantage of not modifying the flow field by pumping (Kalbus, 2006). It is, nevertheless, recommended to use them in conjunction with other techniques that can provide a broader scale assessment of subsurface hydrochemistry (Bridge, 2005).

¹ Technical information available at <http://www.dgtresearch.com/>

8.4.2.11 *In situ* chambers and microcosms

In order to create an environment that can be controlled, while responding to natural conditions, a small area of the streambed can be enclosed. Generally the setup used for biogeochemical measurements is called an *experimental chamber* when it contains *in situ* undisturbed sediments and a *microcosm* when it is pre-filled with a substrate (Bridge, 2005). Both are designed to facilitate *in situ* measurements of metabolic parameters and rates. References on the use of microcosms can be found in Baker et al. (2000). Although this approach can provide useful information, it is relatively labour-intensive and yields results at a single location.

Similar methods can be used to study the fauna. In the case of *macroinvertebrates colonization chambers*, a container filled with substrate is inserted into the streambed (Figure 8.10). The system is then given some time to settle down and allow for colonization, typically one month. A similar concept involves creating traps for hyporheic invertebrates. In this case, chambers may be installed in the substrate, with or without bait, and then removed and sorted for invertebrates. Wells have been used as unbaited traps by Hahn (2005).



Figure 8.10 Colonization chambers. From Grant et al. (2007).

8.4.2.12 *Geophysical methods*

Geophysical methods can be used to map the extent and nature of subsurface geologic materials. In hydrological studies, geophysics is commonly employed to determine the depth to the water table and bedrock, or to map the geometry of sedimentological bodies like gravels or clays. Techniques that have been tested at the GW/SW interface include *ground-penetrating radar* (Bradford et al., 2005), and *electrical resistivity imaging* (Figure 8.11. Acworth and Dasey, 2003; Crook et al., 2008). Although such methods may be thought of as non-intrusive, they are often used jointly with coring techniques that provide the ground-truth. At a large scale, remote

sensing technologies such as *airborne electromagnetics* have also been applied in studies related to GW/SW interactions (see Brodie et al., 2007).

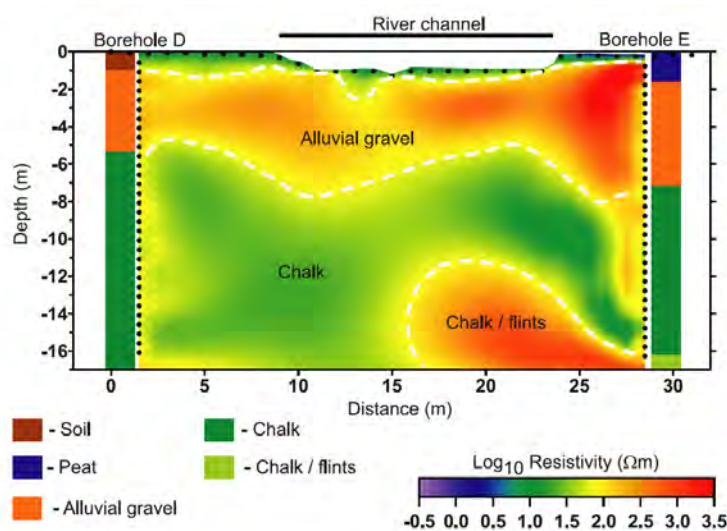

Figure 8.11 Electrical resistivity model from a cross-borehole survey. The locations of the surface and borehole electrodes are indicated by the black circles. The geological logs from the core analysis of each borehole are included for comparison, and the key for these can be found at the bottom left of the figure. From Crook et al., 2008.

8.4.3 Interface measurements

8.4.3.1 Seepage meters

Seepage meters (Figures 8.12 and 8.13) are devices that isolate a small area of the streambed and measure the flow of water across that area. One of the simplest design, the half-barrel seepage meter, uses a cut-off end of a storage drum (steel or plastic) to which a plastic bag is attached, in order to register the change in water volume over a given time (see Rosenberry and LaBaugh, 2008). Seepage meters may be used to obtain a time-integrated hydrochemical sampling of water discharging to the stream. In this case, special care must be taken to ensure that any stream water trapped in the seepage meter has been purged (Lyford et al., 2000).

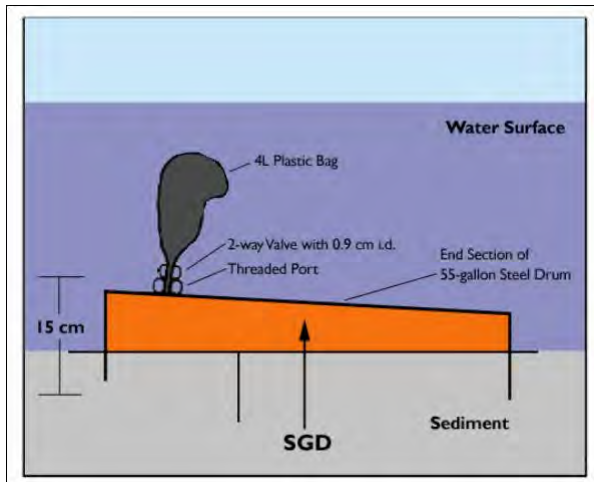

Figure 8.12 Diagram showing a seepage meter installed on a bed and its collection bags attachment. Source: <http://edis.ifas.ufl.edu/SG060> .



Figure 8.13 Four designs of low-profile seepage cylinder shown with a standard half-barrel seepage cylinder made from a plastic storage drum. From Rosenberry and LaBaugh (2008).

8.4.3.2 *Biological sampling*

8.4.3.2.1 **Fish**

Some studies have shown a significant link between groundwater discharge into streams and mortality rates of salmon embryos (e.g. Malcolm et al., 2003). Surveyors document location of redds as they move along the river bank. These locations can be entered into a GIS database and/or correlated with river geomorphic patterns (Geist and Dauble, 1998). Response of redds to the discharge of groundwater can be assessed by egg and alevin survival studies (Malcolm et al., 2003), often using cages with eggs placed in the gravel bed, from which success of incubation can be measured (Baxter and McPhail, 1999).

8.4.3.2.2 **Benthic macroinvertebrates**

Benthic macroinvertebrates are frequently used as indicators of the ecological health of streams. However, studies have shown that GW/SW exchanges can affect community

compositions (Pepin, 2002) even at the scale of a single riffle (Davy-Bowker et al., 2006). Accounting for this influence may help reduce unexplained variability between sampling sites.

For sampling benthic macroinvertebrates, two typical approaches include (Storey et al., 1991) *timed-area sampling with a kick-net*, in which the substrate is disturbed by kicking at it upstream of a portable kick-net (this can be seen as a broad and semi-quantitative method) and *specific area sampling*, which provides a more quantitative approach, allowing for estimations of invertebrate density. This second technique typically involves the use of fixed-area samplers such as the Hess and Surber samplers (see Figure 8.14). The substrate within the sampler area is disturbed, generally to 10cm depth, and the dislodged debris are caught in the attached net as they float downstream. In general, these devices are limited to less than 0.5 m², and multiple samples are taken to calculate average density.

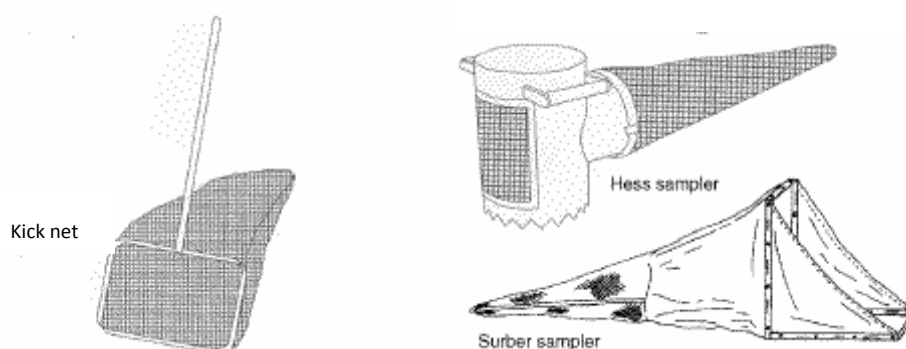

Figure 8.14 Benthic macroinvertebrates sampling devices. From Storey et al. (1991).

8.4.3.2.3 Meiofauna

Meiofauna are those animals smaller than 500 µm and larger than 40 µm. Young instars of many benthic invertebrates can also be found as temporary members of stream meiofauna communities (Palmer et al., 2006). Studies have shown that meiofauna can dominate stream communities in terms of abundance and species richness (Robertson et al., 2000, Rundle et al., 2002). Thus, they could provide a useful tool in examining responses to management actions at the GW/SW interface. Sampling for meiofauna requires the use of smaller mesh sizes and thus sampling methods used for macroinvertebrates must be modified. Combining the methods for hyporheic invertebrate and benthic invertebrate sampling as well as using tools such as plankton nets provides a suite of tools for sampling meiofauna in various environments (Palmer et al., 2006).

8.4.3.2.4 Periphyton

Periphytons are benthic assemblages made of photoautotrophic (algae including diatoms) and heterotrophic (including bacteria) organisms growing on the stream substrate (Chapter 6). They are a useful tool for assessing nutrient status and stream health (Kelly, 2008; Lear, 2009). Furthermore, recent works have shown their potential dependency to the distribution of groundwater discharge (e.g. Pepin, 2002). Methods for benthic periphyton collection involve scraping or brushing the biofilm off natural (e.g. cobbles, plants, see Figure 8.15) or experimental (e.g. tiles, slides) substrates. Collected samples are then either preserved for

identification, or filtered for biomass and productivity estimates. In the UK, the DARES project² aims at assessing the stream ecological status based on benthic diatoms (Kelly, 2008). It uses the Trophic Diatom Index (TDI), based on the identification of a set of taxa, to describe the level of anthropogenic impact on the stream ecosystem.

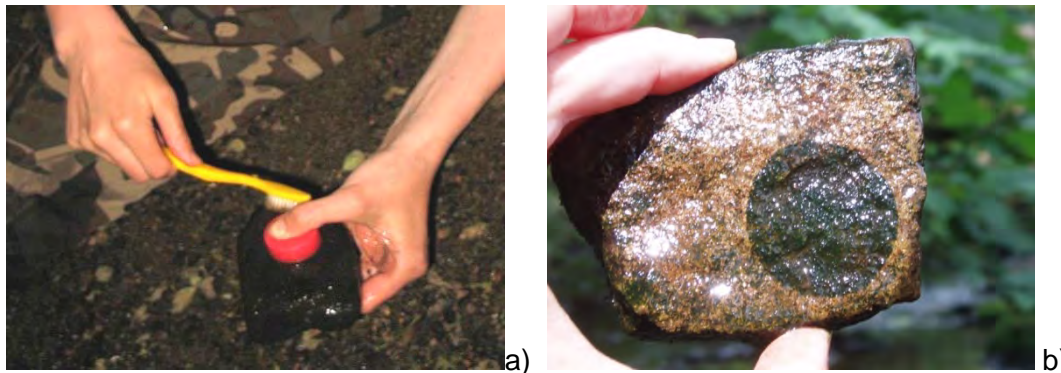

Figure 8.15 a) using a soft bristle brush to remove periphyton from around a know area (photo: S. Kelly); b) known area of periphyton to be collected in to sample container (photo: Anna Ritchie).

8.4.4 In-stream measurements

8.4.4.1 GW and SW fluxes

Net gains or losses of stream water, caused by GW/SW exchanges, can be estimated by *differential flow gauging*, that is by calculating the flow difference between the two ends of a stream segment. This method requires the input of surface tributaries to be known, as well as the errors in stream flow measurements, which controls the limit of detection. For more details, the reader is referred to Rosenberry & LaBaugh (2008).

If a stream flow time series, or hydrograph, is available, several processing techniques are available to estimate the baseflow component of stream flow. These *hydrograph-* or *baseflow-separation* methods (Figure 8.16) provide a spatially lumped estimate of the magnitude and timing of groundwater contribution to stream discharge (Brodie et al., 2007). They are mostly used in gaining streams, providing the assumption can be made that baseflow equates to groundwater discharge (i.e. no human activity controls the baseflow).

² Diatoms for Assessing River Ecological Status. http://craticula.ncl.ac.uk/DARES/dares_project.htm

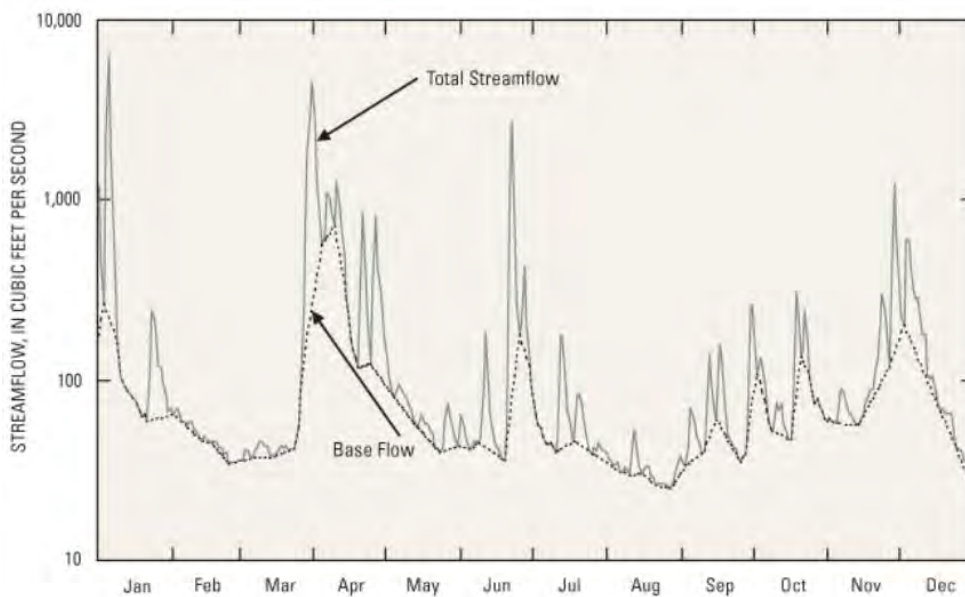

Figure 8.16 Hydrograph separation on Nith River at New Hamburg, Ontario. From Neff et al. (2005).

8.4.4.2 Hydrochemical sampling

A *single grab sampling* can be carried out in all well-mixed streams or small rivers. If stream flow is measured, then chemical fluxes can be estimated as well. In order to reflect hydrochemical variability, one may carry out a *composite grab sampling*, whereby samples are spatially or temporally distributed, according to the river's geometry, to a sampling period or to stream discharge (see Bartram and Ballance, 1996). The latter approach can be conducted through manual or automated sampling. Recent developments in automated *in situ* monitoring give the opportunity to record continuous time series of parameters that traditionally required standard laboratory analytical techniques, e.g. soluble reactive phosphorus concentration (Orr et al., 2006).

8.4.4.3 Biological sampling

8.4.4.3.1 Fish

Fish are of primary interest to river managers. In some environments, during hot or cold periods, they may benefit from the thermal refuge provided by upwelling groundwater (Hayashi and Rosenberry, 2001). For large spawning fish such as salmonids, observation through bank-side surveillance and in-stream snorkel surveys provide direct means to map fish locations. In some waters, snorkelers proceed up the river while enumerating fish observed (Li and Li, 2006). In the UK, electro-fishing is the most commonly used method for population assessment (Cowx et al., 2009). It may be carried out on foot in shallower waters or by boat in deeper waters. Two electrodes are placed into the water, creating a zone of electric current that first attracts the fish towards the device, and then stuns them. The stunned fish are then scooped up with nets, catalogued and released. In rivers, a set area is netted off, and usually multiple passes are made in order to calculate population using removal/completion estimates (Li and Li 2006). Hand netting or traps are also often used in the UK (Cowx et al., 2009).

8.4.4.3.2 Macrophytes

Macrophyte communities can be used to calculate indices of ecosystem health, such as those developed by Braun-Blanquet (Van der Maarel, 1975). They also impact GW/SW interactions and associated biogeochemical processes by modifying surface and subsurface water flow and extracting nutrients and other solutes from the water column and from the sediments (White and Hendricks, 2000). This dependency to both stream and riverbed environments can be used to provide indications on GW/SW interactions, where groundwater and stream water chemistry are distinct (White and Hendricks 2000). Many species of macrophytes (aquatic mosses in particular) accumulate metal ions and respond to variation in nutrient concentrations (Carr and Chambers, 1998). Thus, analysis of plant tissues can be used to indicate areas of exchanges, in particular where groundwater sources are contaminated with heavy metals (Elgin et al., 1997).

Various survey methods exist for estimating the community composition of aquatic macrophytes. These include standard vegetation mapping techniques (Figure 8.17) such as using visual estimation, point transects, and plot surveys (Knapp 1984).

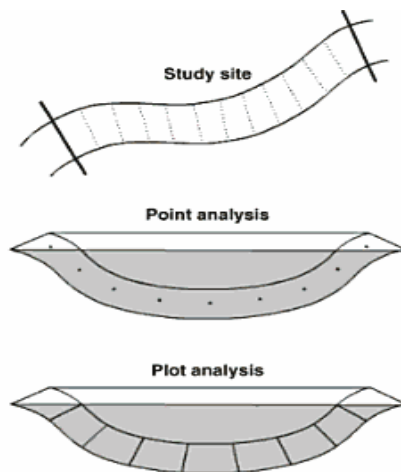

Figure 8.17 Diagram of a study site design for macrophyte surveys with details of point and plot type survey schematics. From Bowden et al. (2006).

8.4.4.4 Artificial tracers

8.4.4.4.1 Hydrological applications

- **Transient storage measurement**

In-stream tracer tests (Figure 8.18) can help characterise the temporary retention of stream water in the subsurface. In a typical experiment, a non-reactive solute (e.g. Rhodamine WT) is injected into the stream, and its passage is monitored tens or hundreds of metres downstream. This method assumes that physical retention of water in the subsurface is evident as an 'imprint' on the breakthrough curve. Ideally, this curve is a mean to estimate reach-averaged parameters such as the flux between the stream and the hyporheic zone (HZ), the residence time of water in the HZ, and the dimensions of the HZ.

However, in practise the approach works when retention is caused only by hyporheic exchange, as opposed to in-stream storage. Therefore, it is rather designed for well-mixed streams. In addition, its 'window of detection' is weighted toward the short flow paths and residence times (hours to a few days) – see Harvey and Wagner (2000).



Figure 8.18 Adding Rhodamine WT dye to a stream. From http://toxics.usgs.gov/photo_gallery/instreams.html .

- **Groundwater inflow and outflow rate measurement**

Groundwater inflow and outflow over a stream segment can be estimated by coupling two widely-used stream flow gauging methods, *velocity-area gauging* and *dilution gauging*. In this approach, stream discharge is measured at both ends of the reach through a single in-stream tracer test (dilution gauging) conducted at the upstream end. At the downstream end, a velocity-area gauging is carried out as well. From this data and through a simple mass balance, described by Harvey and Wagner (2000), three fluxes can be determined: the net gain/loss of groundwater by the stream; groundwater discharge into the stream; and stream infiltration into the aquifer. The limit of detection depends on the error associated with the two gauging methods.

8.4.4.4.2 Hydrochemical applications

- **Solute uptakes**

Since the 1980s, research has been investigating the influence of hyporheic exchange on the reactive uptake of stream solutes. To assess the role of biogeochemical processes relative to dilution, a standard approach consists of

performing in-stream tracer tests that combine conservative and reactive tracers (e.g. Lautz and Siegel, 2007). This approach provides a useful mean to quantify the 'uptake length' of solutes, i.e., the average distance an atom travels before it is taken by an organism (Duff and Triska, 2000, p. 202).

8.4.4.5 Environmental tracers

8.4.4.5.1 Hydrochemical tracers

Areas of groundwater discharge may be identified from within the stream, by measuring variations in the concentration of environmental tracers (see Section 3.2.3). In some conditions a quantitative estimation of the GW discharge rate can be obtained through a mass balance. While some tracers lend themselves to continuous measurements by towing (by foot or boat) a probe in the stream, e.g. temperature (see Vaccaro and Maloy (2006)), other tracers require a discrete sampling procedure, for example ^{222}Rn (see Mullinger et al. (2007)).

8.4.4.5.2 Heat as a tracer

Thermal Infrared imagery (aerial or terrestrial) has been used to detected zones of groundwater discharge in areas where such inputs modify the stream's temperature. This technique is effective only if surface water and groundwater temperatures are appreciably different – see Rosenberry and LaBaugh (2008).

Distributed temperature sensing (DTS) is a recent technology, which can be used to detect small variations of temperature along a fibre-optic cable laid on the streambed. While the cable may be as long as ten kilometres, the thermal resolution can be as low as 0.01 °C, and the spatial resolution as fine as one metre (Selker, 2006).

Method	Advantages	Limitations	Requirements	C	B	FC	FQ
Hydrographic analysis	Describes temporal changes of GW contribution to stream flow; catchment scale information; can be carried out as a desktop study; analysis techniques available	No information on spatial distribution; applicable to gaining streams only; analysis difficult when stream flows are affected by human activities such as flow regulation	Stream flow time series; possibly a software for data analysis				✓
Environmental tracers (chemical)	Can provide a wide range of information, e.g. input data for mass balance models; some devices are inexpensive (e.g. EC or pH-meters); spatial surveys and time series possible; application to stream profiling	Sampling can be time consuming and analyses expensive	Analytical equipment and high-level of expertise			✓	✓

Stream profiling	Can provide data on the spatial distribution of GW inflows or inputs of contaminants; good reconnaissance tool.	Useless when GW and SW concentrations are similar; tracers can be sensitive to other factors than GW discharge; possibly time consuming	Analytical equipment and sampling expertise; possibly a boat for monitoring large rivers			✓	✓
Distributed temperature sensing	Can provide data on the heterogeneity of GW discharge along a reach; relatively easy to install	Expensive; estimation of flow are possible, but not necessarily straightforward	Laser emettor and detector instrument			✓	
Thermal Infrared imagery	Can provide spatial information on GW discharge into streams	The temperature difference and GW discharge flux must be high enough to allow for detection	Infrared camera or available remote sensing images			✓	
Geophysics	Set of non-intrusive techniques allowing for a mapping of the subsurface lithology	Techniques have different limitations with respect to their capacity of detection (e.g. depth, reliability, type of sediments, buried structures...)	Adapted geophysical equipment			(✓)	
Differential Flow gauging	Standard equipment, can provide temporal and spatial data if successive reaches are surveyed; inexpensive method in small streams	Possibly time consuming; difficult in high flow conditions; provides only the net GW input along a reach; resolution limited by accuracy of measurements	Flow gauging method			✓	✓
In-stream tracer injection	Useful for characterizing hyporheic exchange flow, groundwater discharge, solute transport, or surface-subsurface connections	Usually requires an authorization (often difficult to obtain around water supplies); health and ecotoxicological issues; can be time and money consuming; problems of uncontrolled sorption and degradation	Careful planning and knowledge of the system (once the test is performed, the tracer might remain in place for a long time); expertise; injection and monitoring equipment			✓	✓
Large wells	Enable estimations of hydraulic conductivity and chemical characterization over large areas	The presence of a stream can make the results difficult to interpret; expensive to install; requires specific equipment for depth specific sampling	An existing well; pumping equipment; for pumping tests, at least an observation well; a multi-level packer for depth-specific sampling	✓	✓	(✓)	✓
Small wells	Allows for head	Not appropriate for	Adapted drilling	✓	✓		✓

	measurements in the riparian zone if flow is horizontal; allows for chemical and biological sampling	sampling at a specific depth	equipment and well; pumping equipment				
Piezometers	Allows estimations of permeability; indicates seepage direction and possibly intensity; shallow piezometers (~ <3 m); rapid and relatively inexpensive installation	Power-auger or a drill rig can be required; estimate of potential flow rather than direct measurement	Adapted drilling equipment and piezometer; pump or net for sampling	✓	✓	✓	✓
Multi-level samplers	Allows for chemical sampling at specific depths	Tubes usually too small to perform hydraulic testing; clogging issues in fine sediments	Multi-level sampler (hand-made or commercially available); equipment for installation	✓	✓	✓	
Seepage meter	Direct measurement of flux and subsurface water sampling at the sediment-water interface over a small surface area; cheap; good for semi-quantitative information	Potential sources of error associated with design and operation; measured flux is time-averaged; unsuitable for fast-flowing, gravel-bed or heavy clay-bed streams; chemistry of the discharging GW can change in the seepage chamber and not represent subsurface conditions.	Seepage meters are generally hand-made.	✓			✓
Portable standpipe	Relatively quick and inexpensive to install; mainly used to sample fauna	Relatively shallow sampling depth; is sensitive to surface water contamination during installation	Standpipe and hand-operated piston pump	✓	(✓)		
Hydraulic potentiometer	Portable devices which allows for a rapid measurement; can indicate seepage direction (and intensity if permeability is known)	In low permeability sediments, may require a long stabilization time; measurement error if leaks, clogging or bubbles appear in the device	A robust device, generally hand-made				✓
Subsurface tracer injection	Direct measurement of flow velocity, direction, solute transport and transformation, and characterization of subsurface connectivity;	Prior to the test, flow direction must be known or a network of piezometers must exist if sampling the subsurface; time consuming over long distances or low	Tracer, injection and detection equipment; well(s) or piezometer(s)			✓	✓

	relatively rapid over short distances or in high hydraulic conductivity materials	hydraulic conductivity materials					
Temperature as a tracer	Temperature probes are generally robust, simple and relatively inexpensive; can provide time series of vertical flux; good for semi-quantitative information	Requires a temperature difference between SW and GW; analytical solutions assume vertical flow	Temperature probes, a logger; possibly heat transfer modelling software			✓	✓
Point-dilution test	Direct quantitative measurement of flux; relatively simple and inexpensive procedure	Quantitative estimation of flux is possible only when subsurface flow is horizontal;	A piezometer or a pit, a tracer, an injection and monitoring equipment				✓
Slug test	Enables a local estimation of hydraulic conductivity Simple to carry out and analyze, inexpensive	Measurement errors if the screen is clogged; possible errors caused by fine sediments disturbing the test	A piezometer; test need to be replicated; expertise is required in results' analysis				✓
Sediment cores	Potential to combined hydraulic conductivity, chemical and biological analyses of thin sections; useful for laboratory tests (e.g. perfusion core); easy sampling when sediments are fine and shallow	Empirical formula for estimating hydraulic conductivity are not always reliable; impossible to repeat sampling at the same location; preparing samples for analysis can be time consuming; freeze coring augering require heavy equipment	Plastic tube, hand-auger, power-auger or drill rig; appropriate analysis equipment; liquid nitrogen for freeze coring	✓	✓		✓
Measurement probes and passive samplers	<i>In-situ</i> measurements of physico-chemical parameters, allows for high spatial resolution analysis and time integrated measurements; can detect low concentrations	Passive samplers can require a long sampling period	Probes and passive samplers (commercially available); analytical equipment for gel-probes processing	✓		✓	
Microcosms and colonization chambers	<i>In-situ</i> assessment of physical and biological processes	Long time between installation and sampling; assessment of small volume of sediment; rather intended for research than routine	Container filled with substrate	✓	✓		

		surveys				
Exposed sediment sampling (Karaman-Chappuis method)	Cheap and easy; avoids contamination of surface water	Limited to exposed sediments; the water table must be shallow	A trowel; a cup or a hand-pump	✓	✓	✓
Benthic sampling	Fast, easy, no complex gear, established methodology for surface applications	Community associations with groundwater influence less known but currently being researched; lab-identification is time-consuming	Nets, sorting trays, preservative, vials for invertebrates, toothbrush, sample jar, filter set-up (biomass/chlorophyll a) and/or Lugols Iodine (identification)		✓	✓

Table 8.1 Summary of monitoring techniques; largely inspired by Brodie et al. (2007) and Rosenberry and LaBaugh (2008). Techniques are roughly sorted from the coarser to the finer scale of application; the spatial scale associated with a technique is mentioned for all methods except point (or local) measurements, for which the obvious limitation is that they do not provide insight on spatial distribution unless a network of monitoring points exists. Columns C, B, FC and FQ respectively refer to the following monitoring objectives: hydrochemical sampling, biological sampling, flowpath characterization and water and solutes fluxes quantification.

8.5 Conclusions

The interface between streams and groundwater constitutes a special part of the hydrologic system. It is typically characterised by a high biodiversity and a strong chemical reactivity. However, this environment is heterogeneous and dynamic, and therefore difficult to study. Its hydrological and biogeochemical properties may appear to change with the scale of observation. Therefore, in order to monitor hydrological, chemical or biological parameters, not only a technological expertise is required but also knowledge about the natural processes structuring the interface. Together, these skills will help designing monitoring schemes adapted to specific sites and investigations. A whole range of scales can be covered by the various approaches. Consequently, prior to selecting a method it is critical to understand both its limitations and the natural system under investigation. A sensible monitoring approach is likely to make use of various tools, and build upon an appropriate trade-off between a high measurement resolution and an extensive areal or temporal coverage.

9 Modelling and forecasting

9.1 Summary of key messages

9.1.1 Conceptual models summarise our understanding

A model is a representation of conceptual understanding of a scenario or situation. We usually refer to models as the set-ups within modelling software that generate a set of numerical results. By crystallising the understanding and concepts governing a problem, well-designed models can generally provide a beneficial contribution to a project.

If there is no time for anything else, it is worth preparing a conceptual model. A first step is to draw a sketch summarising the scenario in question. As such, it provides a valuable basis for common understanding and discussions between project members and stakeholders.

Understanding the flow regime is fundamental, even if solute transport is the primary focus. A conceptual model of a flow regime considers a given area (volume), and looks at inflows, outflows and (for transient models) changes in storage, forming what is often referred to as a 'water balance'.

Where the development of conceptual model highlights a lack of understanding in some important aspect, it may be necessary to return to the problem and collect more data, or revisit the literature to understand a process better. This will save time in the long run, as there will only need to be one subsequent attempt at modelling.

The exact nature of the conceptual model is not fixed: it depends, for instance, on the scale of the problem, and the time-scale of interest (steady state versus transient).

It is always worthwhile trying to do some level of calculations. They may highlight data shortfalls or inconsistencies in understanding. The calculations can provide a basis for subsequent judgment of reasonableness of results from any modelling software, and may help in setting model parameters. Maybe, for a given level of confidence, simple calculations will avoid the need for modelling.

9.1.2 Numerical models quantify our understanding

Most numerical models are used to quantify or explore a given conceptual model – they can't highlight missing components. It is therefore worth taking time to formulate the conceptual model carefully.

Models use 'parameters' as input, which may be based on physical processes or empirical relationships (see later). They produce predictions of levels and flows (flow models), or concentrations and mass loads (solute models) as output.

Models are available in a range of sophistications – it is important to choose the level that is appropriate to your decision. Things that affect your choice are available data, scale (regional versus local), budget and time scale of project, required confidence in results, availability of trained personnel or consultants and importance of the issue.

A tiered approach is more established in some branches of the science (e.g. risk assessment) than in others. However, the principles of a tiered approach are certainly transferable: as tiers increase, more detail (data and/or numerical complexity) is required, but greater confidence in results may be achieved, and less uncertainty may be inherent. Progressing through the tiers ensures early, usually conservative, 'results' (a useful fall-back position if difficulties are encountered at a later stage), and a growing understanding of the problem (even a simple model may yield useful insight, whereas struggling to build up a complex model from scratch may end up absorbing too much time). A tiered approach may mean progressing through different types of modelling software and/or collecting more data at each tier to support the modelling.

Few models explicitly allow explicit detailed representation of the hyporheic zone. However, some modelling software may be used in a non-standard way by experienced modellers to take account of the particular conditions.

Simple models may give a mistaken impression of accuracy or certainty. In reality the simplicity of the model is likely to have been achieved by making simplifications in the assumptions e.g. uniform horizontal flow in analytical solutions. For this reason, it is always worth checking the assumptions of modelling software before use.

9.1.3 Making predictions and dealing with uncertainty

Uncertainty arises from several sources, including uncertainty in what is happening (processes and scenarios), uncertainty in how to represent it in a numerical model, and uncertainty in what parameters to use in a model.

Remember that all predictions have uncertainty, and factor this into your decisions. Conversely, an appropriate model used with plausible parameter values should be valued as providing the best estimate of the outcome of the conceptual understanding.

Sensitivity analysis allows you to investigate whether uncertain parameters (e.g. through data inadequacies) or processes are important (sensitive), and estimate the band-range of outcomes of a calculation. This is carried out by looking at result of changing parameters, e.g. hydraulic conductivity, according to plausible range of values. Sensitivity analysis may indicate which parameters it is worth spending time in refining your estimates of.

Traditionally sensitivity analysis has been used to find a 'worst case scenario', although decision-making based on the worst case may be costly, impractical and unnecessarily protective.

Probabilistic models attempt to quantify the uncertainty or results based on uncertainty of input parameters. They allow decision-making based on e.g. a 95th percentile, as being more practical than the worst case (100th percentile).

9.2 Review of the science

9.2.1 Introduction

Decisions about environmental management are based on a wide range of information. This will usually include some predictions about the consequences of the decision, and such predictions will come from a model of some kind. This handbook is intended to explain when decisions should take account of groundwater – surface interactions and this chapter provides a basic guide to how models can (or cannot) be used to provide

predictions. It is written to help non-modellers know when a model can be used and the questions to ask if working with an expert. It explains the kinds of model that are available for routine use, their data needs, and the predictions that can be made with the right combination of model and data.

The above implies that a model is a method of making quantitative predictions, and this is how they are usually seen, especially by non-experts; a number of examples are given in later parts of this chapter. Modelling is also a tool to enhance understanding of a problem by requiring one to build a consistent interpretation based on a logical description of the situation and quantification of the variables. Figure 9.1 shows how a mathematical model was used to understand down- and up-welling of flows through riffles. A deeper understanding of how a system works will help the decision-maker, even if quantitative predictions are not possible.

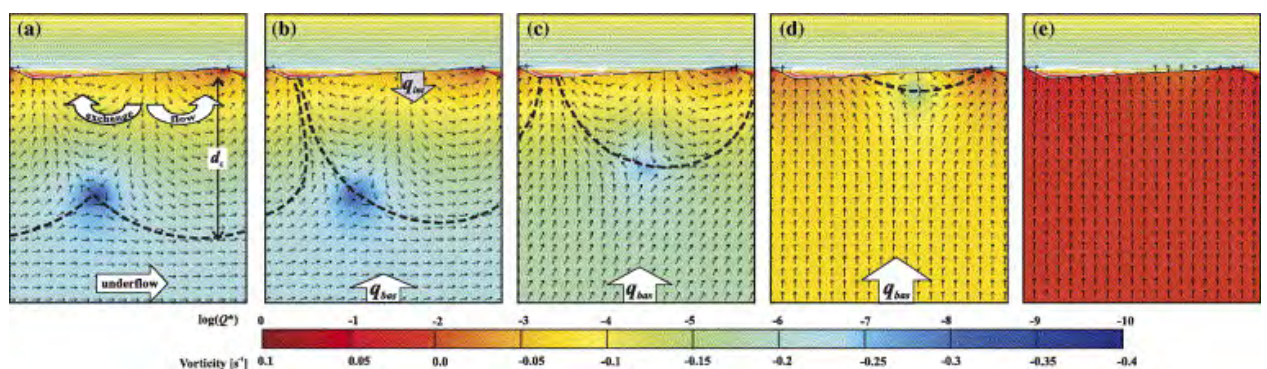

Figure 9.1 Flow patterns beneath riffles for different groundwater influxes. Small arrows are relative groundwater velocities; the dashed black line is a dividing streamline which separates the interfacial exchange zone from deeper zones dominated by ambient underflow or upwelling groundwater flow (Cardenas and Wilson, 2006).

Why model? The environment management context for the groundwater – surface water interface was set out in Chapter 2, and included a sample of the environment management questions that might be asked (Section 2.2). Modelling can help to answer these questions by predicting the likely outcome of future activities which arise from different types of environmental management, for example:

- **Policy:** how important are riverbed attenuation processes on the flux of diffuse pollutants in groundwater discharging to rivers?
- **Regulatory:** how does a proposed abstraction of groundwater affect the ecology into a nearby stream or wetland through changes in discharge or water level?
- **Operations:** how will a proposed re-meandering scheme affect fish spawning by changing the location and quality of groundwater discharge to the river?

Unfortunately, not all such questions can routinely be tackled with models, as will become clear in the remainder of this chapter.

Scales. The environmental management questions also concern different scales. The policy question above is concerned with the overall effect at catchment or river basin

scale; the detail of where and why attenuation might occur is not very important for deciding whether controls on diffuse pollution are required. The example regulatory question is at scales from local to water body and the answer will be affected by the detailed structure and properties of the river-aquifer interface. The operational question on the design of a river restoration may require an answer at the scale of bedforms, i.e. very localised.

Different variables must be predicted to help with different questions. Thus the question on catchment scale diffuse pollution requires estimates of flux of pollutants (e.g. grams per day per km of river), which in turn is likely to be estimated as flow (discharge of groundwater) times concentration. Predicting the impact of a new abstraction on a wetland would require estimates of changes in flow and changes in water level. The re-meandering problem is one of predicting pathways through the hyporheic zone and bedforms; there are likely to be critical times of year for spawning, and estimates must be at this timescale. Overall, the most common variables to be modelled are:

- Flow, usually the change in groundwater – surface water exchange flow that happens in response to a change in the system.
- Concentrations and particularly the attenuation of pollutants.

Scope of chapter. The review covers interactions in either direction between groundwater and surface water, including groundwater dependant riparian wetlands and hyporheic exchange flows. It does not discuss transitional (estuarine) waters or surface water dominated wetlands controlled by sluices. It does not discuss modelling of non-aqueous phase liquids (NAPLs) or sediment transport, and only deals lightly with modelling of ecological responses. It does explain in simple terms the wide range of model types that are available (Section 9.2.2), catalogues approaches to the most common modelling questions for the groundwater – surface water interface (Sections 9.2.3-5), and ends by identifying the questions that cannot yet be modelled, except possibly in research contexts (Section 9.2.6).

9.2.2 Types of model

We will consider here some of the main types of models, with reference to examples of some specific modelling software in common use (see Table 9.1). For a more comprehensive review of models which can represent river-aquifer interactions see Parkin et al. (in preparation).

Empirical Models. In general, models can be classified into *empirical* and *physics-based*. Empirical models are those which aim to find a relationship between sets of variables, without attempting to define any physical basis to the relationship (for example, fitting a line to observed data or artificial neural networks).

Physics based Models. A physics-based model is one which, at least in principle, is constructed on the basis of mathematical relationships which define a set of underlying principles, for example, flows as a function of water level gradients in space. Although there are some examples of empirical models used in the context of river-aquifer interactions, the majority take a physics-based approach, so we will concentrate on these.

Lumped Models. Different types of spatial arrangement can be used to represent field areas (Figure 9.2). The simplest modelling approach is that of *lumped* models. In these, a region is specified (usually a catchment), and a water balance assessment is made generally at annual or sometimes monthly timescales involving calculation of all

inflows (e.g. precipitation), outflows (e.g. river discharge, evapotranspiration, abstractions), and changes in storage (usually dominated by changes in groundwater storage). Lumped models are a useful first step in a tiered risk-based approach to representing river-aquifer interactions. For example, a simple lumped model of an aquifer could, be used to assess annual contribution of groundwater flow to a river, or a more complex lumped model such as Resource Assessment Methodology (RAM; Environment Agency, 2002) can be used to help manage groundwater systems, with abstracted quantities being allocated to more than one river. From a catchment perspective, a calculation of baseflow index (BFI, the ratio of baseflow to total river flow) represents the total bulk exchange of groundwater with a river.

a) lumped (black box)

No spatial information used; mass balances calculated for a whole system (e.g. aquifer or catchment), rate of change in storage = sum of inflows – sum of outflows

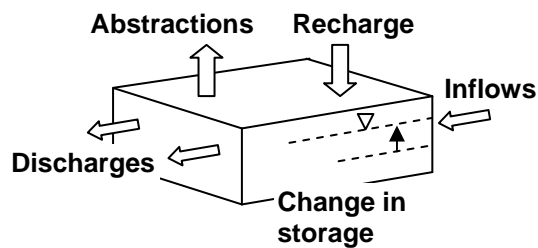

b) conceptual (division into hydrological units)

Some spatial information used based on natural hydrological units (typically catchments, but can be based on aquifer units); lumped model calculations carried out for each hydrological unit

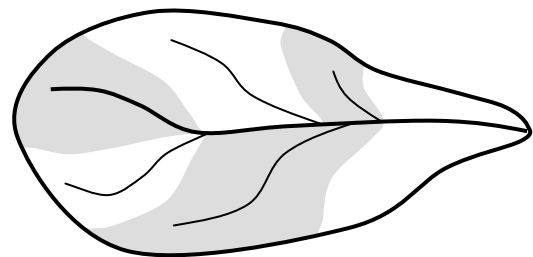

c) spatially distributed finite difference grid

Detailed spatial information used; calculations carried out on a regular grid overlain on the catchment or aquifer; spatial detail depends on scale of grid discretisation; difficult to represent shapes of landscape features accurately

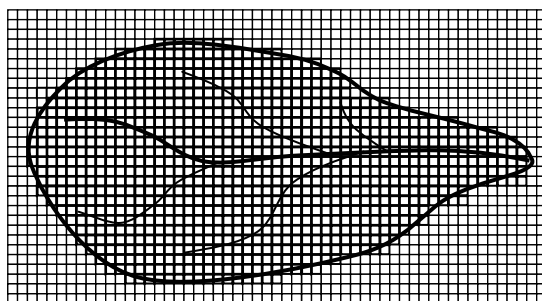

d) spatially distributed finite element mesh

Detailed spatial information used; calculations carried out on a mesh of irregular triangles or quadrilaterals; can represent local areas in detail and landscape features such as rivers more accurately than finite-differences, but at cost of more complicated numerical schemes

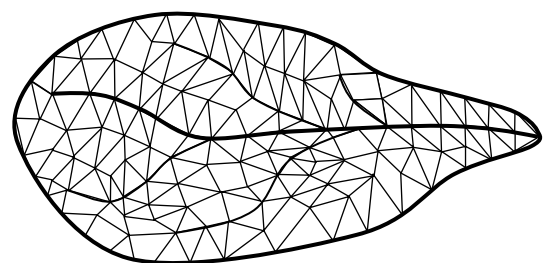

Figure 9.2 Model spatial structures.

Spatially Distributed Models. Lumped models do not provide any representation of how water moves within catchments or aquifers; for example where a river is losing over some reaches and gaining over others. As many water management questions need to take into consideration the relative positions of abstractions and discharges, and the timing of impacts over shorter timescales, *spatially-distributed* models are required. These models are based on mathematical (partial differential) equations describing processes as a function of hydraulic head, h , distributed in space in one, two or three dimensions (x, y, z), and time (t). The equations represent how water moves at any general location so, to construct a specific case study, it is necessary to define the geometry of the region over which the equations apply (i.e. the location of the boundaries, aquifer thicknesses etc), the boundary conditions (e.g. river or lake levels), physical properties and how they vary over space (e.g. hydraulic conductivities, river roughness coefficients), inputs and outputs (including precipitation, potential evapotranspiration, abstractions etc), and initial conditions for a transient model (e.g. groundwater levels at the start of a period of time for which predictions of water level changes are required).

Analytical Methods. Under certain simplifying conditions (typically including homogeneity and uniform thickness of aquifer), an *analytical* solution to the equations can be found (i.e. one in which the hydraulic head, h , can be written as a mathematical function of all other variables). The most relevant software is the IGARF code (Environment Agency, 2004); an example application of IGARF is discussed in 9.2.3.

Numerical Methods. If an analytical solution is not possible (which it is not for many realistic problems), then a solution to the equations can be found using *numerical* methods, e.g. finite differences or finite elements, where a grid or mesh is set up over the region, and hydraulic head values are calculated at a finite set of nodal points. This results in a simplified representation of the conceptual model, as illustrated in Figure 9.3.

a) Conceptual model

Groundwater flows converge in the vicinity of a river with vertical flows beneath the river, and in some cases additional resistance to flow due to river bed sediments with lower hydraulic conductivity than the underlying aquifer.

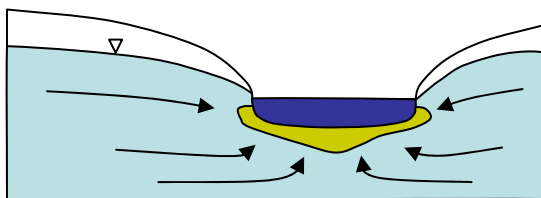

b) Numerical representation

Most numerical groundwater models represent the effects of river-aquifer interactions with a conductance term that includes the effects both of the conductivity of the river bed sediments and the convergent flows with a simplified local geometry.

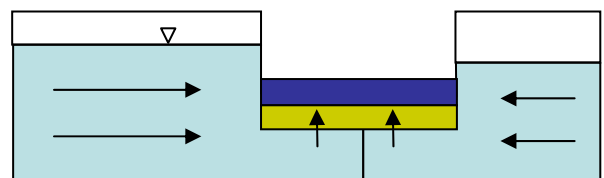

Figure 9.3 Simplified representations of river-aquifer interactions in numerical models.

Groundwater models. The most common types of numerical groundwater model that have been used to represent groundwater-surface water interactions are based on finite-difference methods, including MODFLOW (together with various add-on

components, see Table 9.1). Many of these models use a grid or mesh size that is appropriate to represent the aquifer or catchment scale, with spacings of 200 to 250 m being typical for Environment Agency regional scale groundwater models (smaller grid spacings may be used where smaller scale, specific sites are to be assessed), and include representation of changing boundary conditions (particularly river levels) at a monthly (or sometimes weekly) timescale. These scales are adequate to model bulk exchange flows between groundwater and surface water (i.e. representing baseflow contributions to runoff) and to characterise their regional scale variations, but do not include river flow dynamics at the timescale of storm events and their feedbacks. There are a number of integrated modelling systems which have been designed to represent groundwater and surface water flows and their interactions at these scales, including the 'SHE' models (MikeShe and SHETRAN; Ewen et al., 2000) and Hydrogeosphere (Therrien et al., 2004). These typically work at the hourly timescale (although timesteps may vary from minutes to days, depending on hydrological conditions).

Outputs calculated by these models include groundwater and river levels, bulk exchange flows between rivers and groundwater, and river flows (total flow from integrated models or only baseflow from groundwater models). It is possible to generate data from these outputs for use in assessment of water quality and aquatic ecology. For example, river velocities can be estimated for use in assessment of habitat suitability for salmonids based on assumptions about river cross-sections, and average residence times in the hyporheic zone can be estimated from bulk flows for use in determining attenuation rates of diffuse pollutants. However, when applied at the catchment or aquifer scale these models generally cannot represent the spatial variations in flow distributions along river corridors at the scale of geomorphological features such as pool-riffle sequences and of local scale heterogeneities in river bed sediments which are increasingly recognised as being critical for making accurate assessments of biodiversity and water quality status of rivers.

There are essentially two approaches that can be used to refine the spatial scale of model calculations. Firstly, nested models can be used for which data (e.g. groundwater levels) are taken from the outputs of a regional model, and a smaller scale local model is set up using these data as boundary conditions (Figure 9.4). This approach can be used to represent, for example, local scale dynamics of a wetland or flood plain. Some software interfaces are designed to allow appropriate boundary conditions for local models to be set up automatically. A more elegant solution is to refine the grid within a regional scale model around the area of interest. Traditionally, most finite-difference models allowed a limited degree of grid refinement across the whole grid, but more recently software has been developed which allows localised grid refinement anywhere within a groundwater model, although these are not yet in common use. This approach is used in the ZOOM model (BGS, 2004).

a) Nested local model

A fine grid is set up for the local model, which is run separately from the regional model, with head boundary conditions interpolated from the solution on the coarser grid of the regional model to the finer grid of the local model

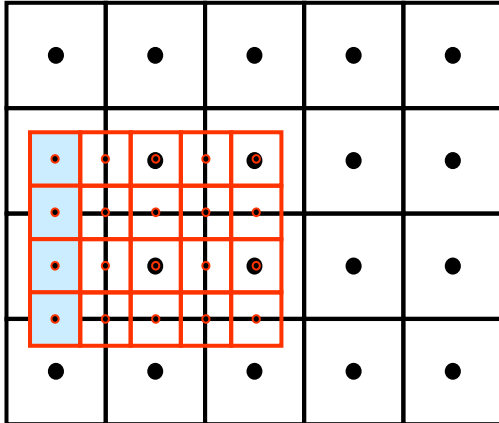

b) Quad tree grid refinement

The grid refinement is integrated into the solution scheme within a single multi-scale model, with progressive levels of grid refinement around a local area of interest within the regional model

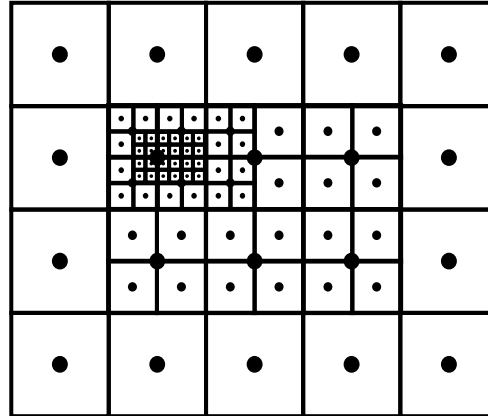

Figure 9.4 Nested regional and local models.

River models. Codes such as Simcat (Environment Agency, 2006) have been widely used to model hydraulic and solute behaviour at a catchment scale. These often use assumed groundwater inflow as a boundary condition, but some models have been coupled to groundwater or catchment models to provide an integrated modelling capability. These externally coupled models can provide some feedback between groundwater and surface water if used properly. The use of this type of approach for modelling contaminant transport is still at an early stage. A type of model that has been used to make useful calculations of contaminant exchange in the hyporheic zone is known as transient storage modelling (e.g. the Otis model, Runkel, 1998). These are often implemented as one-dimensional models of transport across the surface water – hyporheic zone – groundwater pathway, and can represent mixing zone behaviour at individual reaches.

Model Choice. The choice of an appropriate model for a given application depends on a range of factors, including purpose, data availability, level of conceptual understanding, and time/resources available to complete a study. In general, the more complex spatially-distributed models require substantial amounts of effort and data and should be developed only after concluding initial scoping calculations using simpler models. However, for any of these models, questions of model calibration and validation and estimations of predictive uncertainty have to be addressed.

9.2.3 Modelling changes in flows

This section describes how to predict the impacts on flow or stage felt by rivers, springs and wetlands, as a result of human activity, including groundwater abstraction, mining, quarrying and river modification. The Water Framework Directive describes these human activities as pressures.

We will consider ways of estimating both the size and the timing of the impacts. For each pressure we first describe the simple methods for estimating the impacts. These are quick and crude but they nearly always offer valuable insights into our problem. This is especially true if we also make a range of estimates with different plausible input data so that we give ourselves an idea of how sensitive our estimates are to the uncertainty in the input data.

The more complex methods follow; we tend to assume that these more complex representations will give predictions in which we have more confidence. However, this is only likely to be so if we have invested in data in which we have sufficient confidence; a complex model with poor data will still be a poor model.

Finally, we generally have more confidence in our estimates of difference and trends than our estimates of absolute value and so we focus here on techniques for estimating differences.

9.2.3.1 Impacts of groundwater abstraction

One of the problems with estimating the depletion in flow to surface water feature such as a river is that we cannot measure it. It is the difference between the flow in the river when the well is pumping (which we can measure) and what it would have been had the groundwater well not been pumping (which we can usually only infer). Hence we have no observed depletions against which to check our estimates when we use the methods described below and the approach becomes one of gathering clues rather than hard evidence. Clearly, there would be significantly higher confidence in a model if a field experiment, such as periods with the abstraction on and off, had been carried out to provide data to validate the model.

For example, we may wish to assess a 1 MI/d groundwater abstraction which is hydraulically connected to only one surface water feature: a river. The long-term depletion in the flow in the river will be equal to the size of the groundwater abstraction, i.e. 1 MI/d. This is consistent with the principle that the impact of a groundwater abstraction spreads until it has prevented an equal amount of water leaving the aquifer, usually via a surface water feature. In reality a groundwater abstraction is likely to be hydraulically connected to several water features. The above principle still applies so estimating the impact at any one of them is really a problem of estimating how that depletion of 1 MI/d is distributed amongst the surface water features. These may be rivers, springs or wetlands but for the sake of clarity we will initially consider only rivers.

Impact on rivers

An instructive way to look at this problem is by considering the hydraulic resistance between the pumping well and each surface water feature. At its simplest this comprises two resistances in series which can be added to give the total resistance. These are the resistance of the path through the aquifer and the resistance of the path through the river bed.

For two rivers of the same length, the resistance of the path through the aquifer (R_{aq}) is proportional to the path length through the aquifer (L_{aq}) and inversely proportional to the transmissivity (T):

$$R_{aq} = L_{aq} / T \quad 9.1$$

The resistance of the path through the river bed (R_{bed}) is proportional to the path length through the river bed, the river bed thickness (L_{bed}), and inversely proportional to the hydraulic conductivity of the river bed (K_{bed}) and the width of the river (w):

$$R_{bed} = L_{bed} / (K_{bed} \cdot W) \quad 9.2$$

A surface water feature with a large resistance along the pathway to the well will experience less depletion than another surface water feature with a small resistance. A valuable feature of the hydraulic resistance concept is that it correctly predicts that groundwater flow divides make no difference to the spread of impacts and this is described in more detail in Section 2.4 of the report on hydrogeological impact appraisals for groundwater abstractions (Environment Agency, 2007a). For example in Figure 9.5 the groundwater pumping from the wells reduces the flows in all five rivers even though there are groundwater divides between the rivers.

The report on hydrogeological impact appraisals (HIA) for groundwater abstractions (Environment Agency, 2007a) provides a good description of these issues. Section 2.4 of that report lists some common misconceptions, Box 4.2 describes a resistance calculation and Section 4.2.4 describes some common tools for apportioning depletion.

Analytical solutions. There are several analytical equations (e.g. Jenkins, 1968) which are designed to calculate the depletion of flow from a surface water feature due to a pumping well but these tend to assume that only one surface water feature is affected. If you are sure this is so, perhaps after doing some rough resistance calculations, then these methods may be appropriate.

IGARF. The IGARF spreadsheet (Impact of Groundwater Abstraction on River Flows) produced by the Environment Agency (2004) uses several analytical solutions to generate estimates of depletion over time and space for two rivers. The model calculates impacts over short timescales (showing responses from a daily timescale up to months or years as necessary), but it does not have any representation of actual river flows or levels, and therefore cannot include feedbacks of river stage variations. Like the resistance calculations, a hydrogeologist can use this spreadsheet to get an idea of the potential depletion in a few hours.

For example, in Figure 9.5, the circles represent groundwater pumping wells. An IGARF spreadsheet of a single well and the nearest river, the River Leith, shows that the long-term impacts of the abstraction will spread at least 6 km along the River Leith. As there are other bigger rivers within 6 km of the pumping wells (Eden and Lyvennet), it would be unwise to assume all the depletion comes from the Leith. This rapid analysis with IGARF shows that an approach is required which takes into account all four the hydraulically connected rivers.

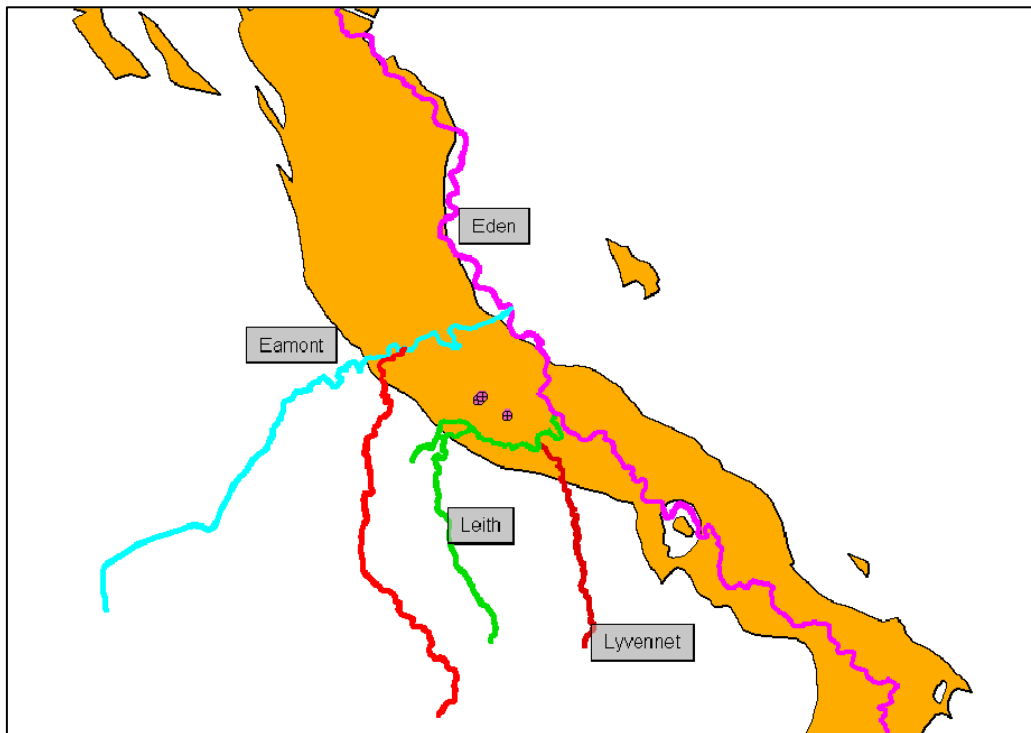

Figure 9.5 The Eden valley river system in North West England.

Distributed numerical models. The Environment Agency has more than 40 regional groundwater models covering the major aquifers in England and Wales. The Environment Agency's forthcoming National Groundwater Modelling System (NGMS) will give some organisations access to these regional models. If you have access to one of these models for your area, they will give the most reliable estimates of the size and timing of river flow depletion due to groundwater abstraction at each connected river because it will include all the major surface water outlets. However, these models are calibrated using the flows at the main river gauging stations so we can expect to have confidence in the estimates of flow reduction at this scale (i.e. reaches of several kilometres) but not at the much smaller scales that may be required for detailed ecological studies.

Simplified numerical models. In the case of the Leith (Figure 9.5) there was no numerical model of the region but it only takes a few days for an experienced groundwater modeller to build a simple 'depletion' model in MODFLOW. This is a model which aims to predict flow deletions only. It will incorporate the regional aquifer properties, all the important hydraulically connected surface water features and the abstraction well(s) we want to investigate. We do not need to include the other abstraction wells in the aquifer nor the recharge because as shown in the work by the BGS and the Environment Agency (2008), these do not usually influence the depletion estimates significantly. Avoiding the large uncertainties in recharge estimates will increase confidence in the results, but such a simplified model will not capture transient behaviour, such as changes between seasons and across years.

Impact on wetlands and springs

As with rivers the hydraulic resistance between springs or wetlands and a pumping well can be used to estimate how the impacts of pumping are likely to be distributed amongst all the surface water features connected to the pumping well. The

Hydrogeological Impact Assessment (HIA) report (Environment Agency, 2007a) describes the steps for carrying out such an appraisal for all water features in an area.

9.2.3.2 *Impact of mine dewatering and river modification*

There are many similarities between groundwater dewatering for mining and quarrying and abstraction. The Environment Agency has written a hydrogeological impact appraisal (HIA) guide on this issue (Environment Agency, 2007b). Section 3.4 of the HIA describes over 20 analytical equations which were assembled from various sources, textbooks and other publications, into a Microsoft Excel spreadsheet. The approaches for assessing the impact of dewatering on surface water features are the same as those for groundwater abstractions described above.

River channel modifications as part of flood defence or river restoration schemes could easily alter groundwater –surface water interactions by changing the stage in a river, lowering the bed, changing the thickness or nature of the bed sediments, or changing the width of open water. Any of these will in turn change the flow between the aquifer and the river. The various approaches to modelling described above, such as analytical and numerical models, apply equally well to the analysis of river modifications.

9.2.4 Modelling solute transport and attenuation

Water exchange at the river-aquifer interface has significant implications on river water quality and river mass loading. For example, river water fed by groundwater polluted by agricultural fertilisers tends to increase the river N concentration and N loading. However, attenuation at the river-aquifer interface can reduce the mass flux from groundwater. Modelling of solute transport in river water, with accounting for river-aquifer interactions, can help to quantify the amount of mass destruction in such a reactive zone, and to identify the major sources contributing to river water contaminant and adapt suitable policy to manage river water and groundwater quality. In this section, we present review of modelling approaches for:

- bank filtration,
- contaminated land risk assessment,
- diffuse catchment scale pollution, and
- effluent discharges.

9.2.4.1 *Bank filtration*

Bank filtration (Figure 9.6) is a system of production wells which are placed near to surface water bodies (e.g., rivers) to increase the public water supply. The abstraction of groundwater from these wells induces surface water infiltration through the river bed to the supply wells. Attenuation of contaminant at the river bed has been observed to reduce the mass flux from the river water into the supply wells. Modelling of solute transport at the river bed could help to predict mass attenuation at the river-aquifer interface and solute concentration in the abstraction wells.

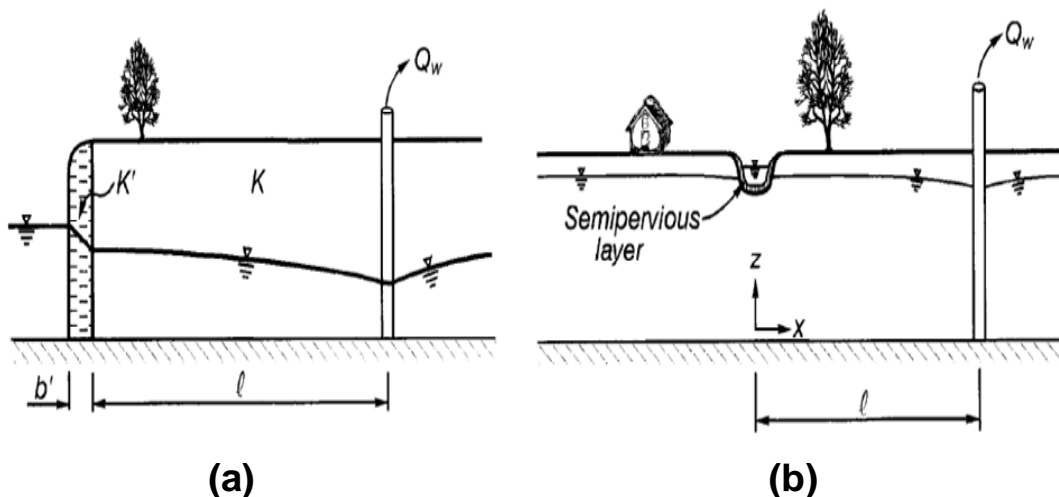

Figure 9.6 Conceptual models of bank filtration by (a) Hantush (1965) and (b) Hunt (1999).

The simplest approach is a mass balance, using water flow rates from one of the modelling approaches above (9.2.3) and river water concentrations. When attenuation at the river-aquifer interface and in the subsurface is negligible, mass discharge from an abstraction well is summed of mass fluxes from river and groundwater. River water concentration and the steam depletion flow rate induced by bank filtration determine the amount of mass flux from the river, and mass flux from groundwater can be estimated from groundwater concentration and groundwater flow rate to the well.

In most cases, attenuation in the subsurface, especially at the river-aquifer interface, could significantly reduce mass flux into the abstraction well, lowering contaminant concentrations in the groundwater supply. Thus, the mass discharge in a supply well of bank filtration is sum of mass fluxes from river and groundwater and mass reductions at the river-aquifer interface and in the subsurface of well capture zone.

The proportion of mass reductions (AF) at these two zones at steady state can be estimated by using parameters like the attenuation rate (e.g., first-order rate constant, k), water travel retention time (t) and retardation factor (R), with a simple equation:

$$AF = e^{-R \cdot k \cdot t} \quad 9.3$$

This approach can be used at the first phase to evaluate the risk of concentration in the river water on the abstracted groundwater in bank filtration.

Modelling of the attenuation processes at the river-aquifer interface and prediction of mass flux and concentration in the abstraction wells can be achieved by MODFLOW/MT3D or more advanced chemical reaction model (PHT3D, Prommer et al. 2003). For example, Ray et al. (2002) used MODFLOW/MT3D to discretise a bank filtration and represented reactions in the subsurface by first-order decay rates (Figure 9.7).

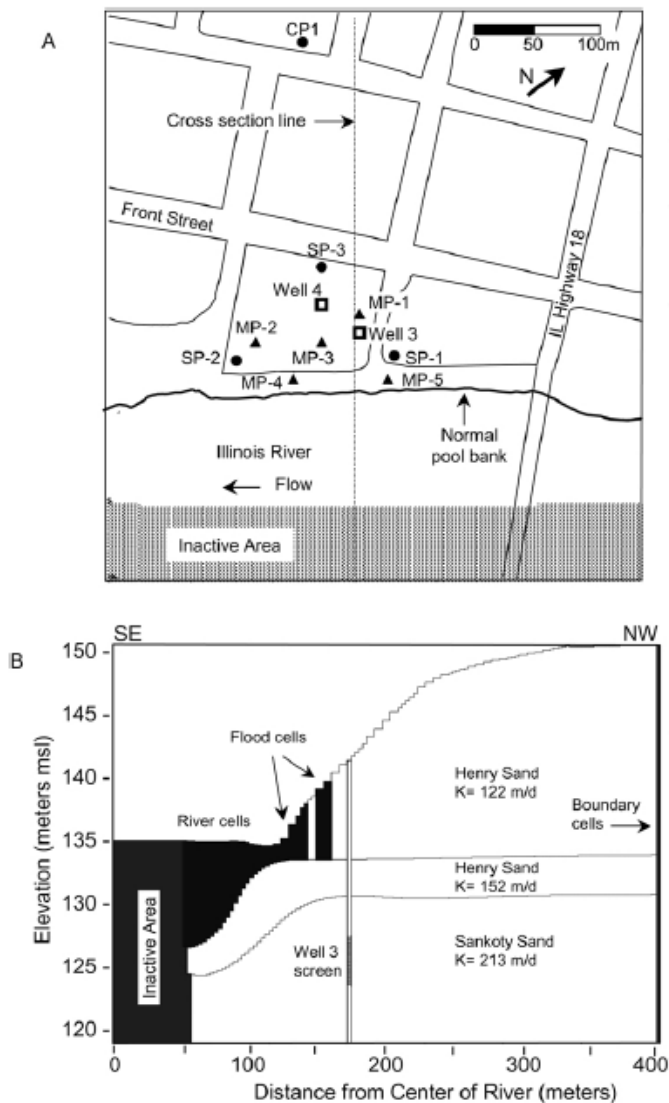

Figure 9.7 Locations of pumping and monitoring wells at the Henry bank filtration site (A) together with model grid and the vertical cross-section (B) (Ray et al., 2002).

9.2.4.2 Contaminated risk assessment

Modelling in support of applications to develop contaminated land (and waste disposal sites etc.) aims for a more simplistic outcome than many other types of modelling. The aim is not to accurately predict a contaminant concentration in some receptor, but merely to demonstrate that the predicted value falls below a threshold for that receptor. Hence a yes/no decision of whether remediation is necessary, or a development may go ahead, may be made.

Defra's CLR11 provides a framework for risk assessment of contaminated land, which is practically implemented by the Environment Agency's Remedial Targets Methodology. In these, a sequential ('tiered') approach to risk assessment is used, which promotes the use of limited data and less sophisticated (but more conservative) models at the early stages of an investigation to screen out sites where the risk is

limited. Only the most contaminated sites, therefore, need extensive data collection and sophisticated modelling.

Current risk assessment models for contaminated land and landfills (e.g. the remedial targets spreadsheet, ConSim, LandSim) have no default capability to assess contaminant attenuation within the hyporheic zone. Some models can explicitly account for the hyporheic zone as a part of the transport pathway (e.g. RISC, ESI's RAM). All tend to use simplistic representations of contaminant attenuation such as linear adsorption and first-order degradation. In addition, they represent contaminant transport along a one-dimensional, steady state, pathway. Where there are two- or three-dimensional, and/or transient, problems to model (e.g. patchy attenuation of PCE observed by Conant et al. (2004)), it is important to take this into account and understand the simplifications of the model.

9.2.4.3 *Diffuse catchment scale pollution*

The leaching of fertilisers and pesticides to the subsurface has serious consequences for the quality of groundwater resources and river water receiving from contaminated groundwater. The natural attenuation of some contaminants (e.g., nutrients) at the river-aquifer interface has been observed to reduce the river contaminant loading from groundwater flux. Modelling of the solute transport in diffuse scale pollution, with consideration of the attenuation at the river-aquifer interface, could help to quantify the reduction of mass flux from groundwater, and to identify the major sources contributing to river water contaminant and adapt suitable policy to manage river water and groundwater quality.

We present a simple method to estimate the amount of mass flux from groundwater contributing to river nutrients loading at a river reach scale. The conceptual model of diffuse pollutants at a river reach scale (L) is shown in Figure 9.8a, where an upland agriculture field is a diffusion pollution source for the river water and groundwater bodies. Figure 9.8b shows a cross-section area of domain where the river bed (or hyporheic zone) is simplified as a rectangular shape with representative river bed thickness (b') and river width (W). Without accounting for attenuation in aquifer and the river-aquifer interface, mass flux from groundwater to the river due to the diffuse pollution at steady state can be estimated by:

$$\text{Mass flux} = \text{Area of agriculture field} * \text{leakage rate} * \text{leaching concentration} \quad 9.4$$

The proportion of groundwater contributing to river mass loading can be determined by the above estimated mass flux, river water concentration and river water flow rate. When attenuation at the river-aquifer interface and in aquifer is significant, a substantial amount of mass might be removed on groundwater flow pathway and at the riverbed before entering the river. The proportion of mass removal in groundwater and at the riverbed can be determined once the attenuation rate, retention time and retardation factor are known.

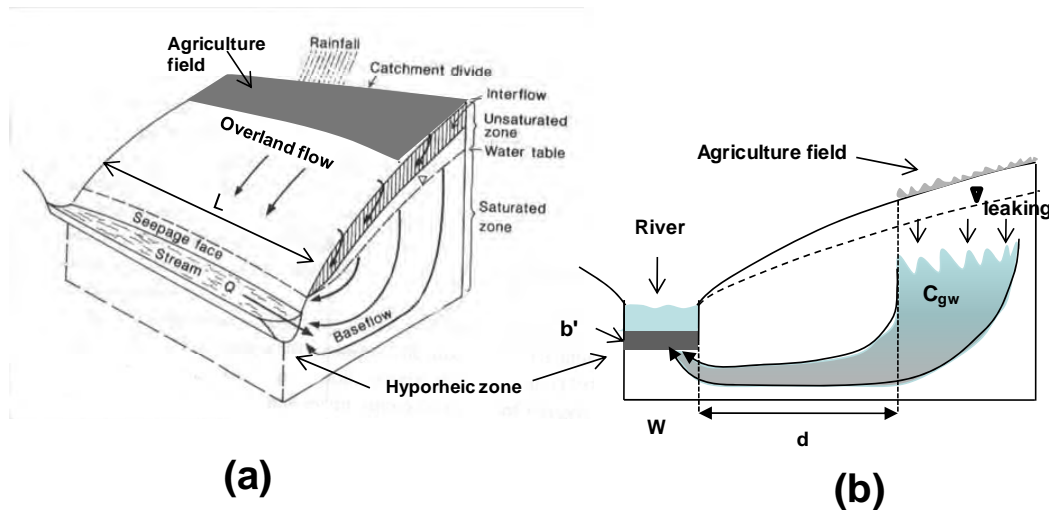

Figure 9.8 (a) conceptual model of a diffuse pollution source from an upland agriculture field (b) conceptual model of mass flux from contaminated groundwater to river water through hyporheic zone in the cross-section area (Hiscock 2005).

There are several models used as management tools to estimate the nutrient fluxes via diffusion pollution in catchment scale. For example, Integrated Nitrogen in Catchment (INCA, (Wade et al., 2002; Whitehead et al., 1998)), Soil and Water Integration Model, (SURFACE WATERIM, (Krysanova et al., 1998; Krysanova et al., 2000)) and nitrate and phosphorus catchment model (TOPCAT_NP, (Quinn et al., 2008)), etc. None of them, however, take account of the interactions in the river-aquifer interface.

Hattermann et al. (2006; 2008) extended the SURFACE WATERIM model to take into account fluctuations of groundwater table and increase update of nitrogen from groundwater in the riparian zones. Denitrification was considered in the process of mass flux from groundwater into the river, by using average denitrification rate and nitrate mean residence time in the subsurface. This model has been used to investigate nitrate flux in the Nuthe catchment (1938 km²) in Germany (Figure 9.9a), where the spatial information including riparian zones, groundwater table contour map, and elevation and soil properties and etc have been specified in the model. The comparison of field observations and model results suggested that the SURFACE WATERIM model could give a reasonable prediction of N concentration in the Nuthe river and a good prediction of baseflow transport behaviour (Figure 9.10); The study revealed that the amount of nitrate uptake from groundwater in riparian zones resulted in 22% reduction of total river nitrate loading (Figure 9.9b).

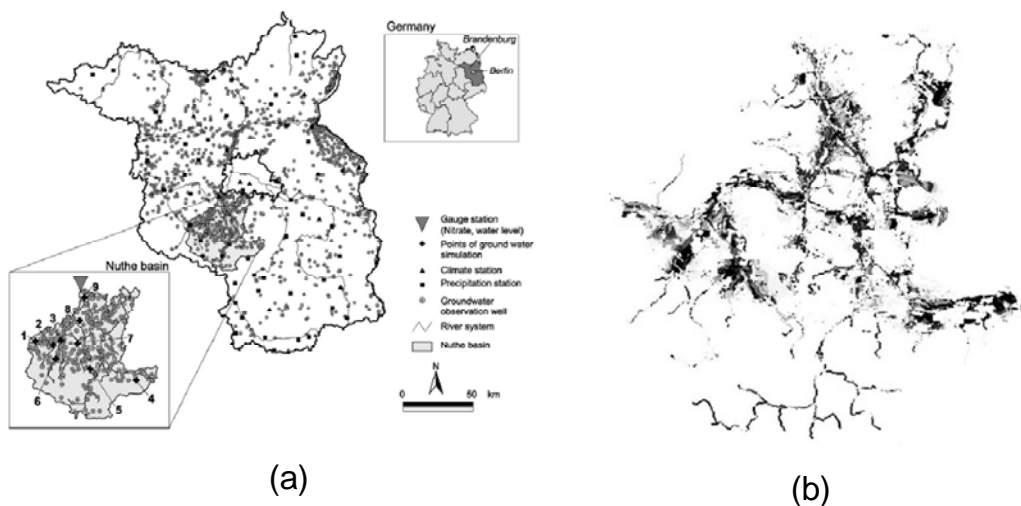

Figure 9.9 (a) The location of the Nuthe basin and the observation points (numbered). (b) Plant uptake of nitrate N from groundwater in wetlands and riparian zones (Hattermann et al., 2006).

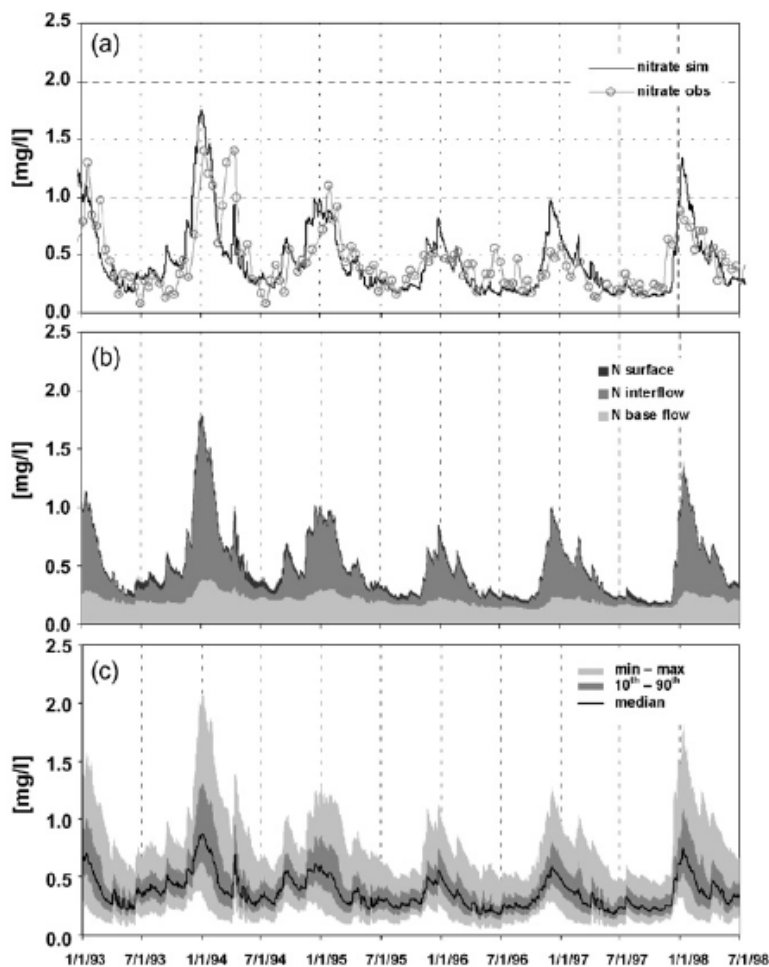

Figure 9.10 (a) Simulated and observed nitrate N concentrations in the Nuthe river. (b) Nitrate N coming with different pathways (with surface runoff, interflow and baseflow). (c) The uncertainty of the simulated results. (Hattermann et al., 2006).

9.2.4.4 Effluent discharges

Effluent discharges from sewage treatment works (STWs) contribute significant amounts to rivers during periods of low flow. The change of river stage by effluent discharges could change the river water and groundwater dynamic at the river-aquifer interface. In a lowland area, the rise of river water level could promote river water infiltrating through the river bed, resulting in the reduction of river mass loading. For example, a study of the South Platte River, Denver, US showed effluent from a STW contributing 95% river water flow downstream, and about one third of river water was discharged to groundwater via river bed in the 20 km downstream of the effluent discharge (McMahon et al., 1995). While in an upland area where river flow might be dominated by baseflow, the rise of river water level by effluent discharges could prevent groundwater entering the river, reducing river mass loading from groundwater. Modelling of effluent discharges which account for water exchanges at the river-aquifer interface could help to identify the effect of effluent discharges on river nutrient loading.

In the authors' knowledge, no attempts have been reported to model the effect of effluent discharges on river mass loading while fully accounting for the water and solute exchanges at the river-aquifer interface. The INCA model was used to predict the nutrient concentrations (NO_3 and NH_4^+) in the River Lee at the north of London, where 5 STWs are located at the upper stream of the river (Figure 9.11) (Flynn et al., 2002). The results revealed that N discharge from STWs significantly increased the N concentration during low flow seasons (summer and autumn). However, the N flux at the river-aquifer interface (e.g., Riparian Zone) and its effect on the nitrate concentration in the river has not been rigorously investigated.

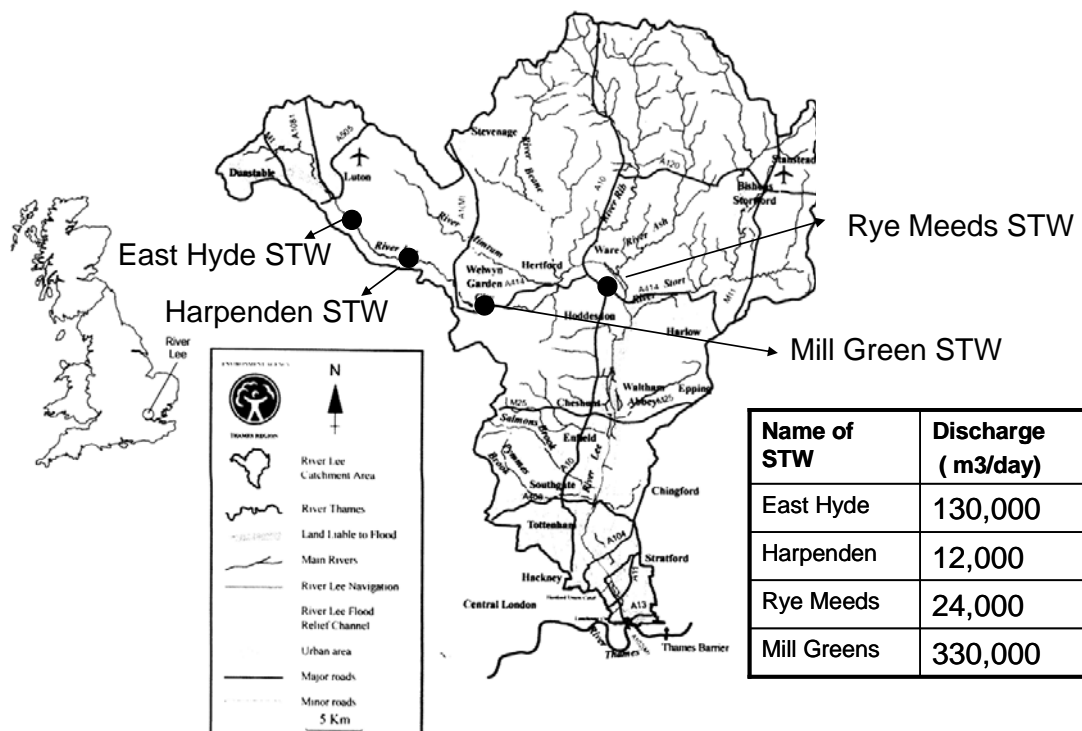

Figure 9.11 River Lee Catchment area: locations and discharges of Sewage Treatment Works (STW) (Flynn et al. 2002).

The effect of effluent discharges on river water and groundwater exchange in the river bed is very likely to take place in a river reach downstream of effluent discharge point. In the case (e.g., a lowland river reach) where effluent discharge promote river water infiltrating through the river bed; the reduction of river mass loading at a downstream river reach (L) can be determined, when the river water concentration, specific discharge in the river bed, length and width of the river reach are all known.

9.2.5 Modelling ecological changes

None of the models which are used as management tools directly include the effects of groundwater – surface water interface on ecology. Even for research, models do not yet have this capability. The effects are predicted in two separate stages, using a model to first estimate the changes in flow, stage or concentration, as described above. The results are then used as inputs for ecological models. This two step process does not allow feedback, for example the growth of macrophytes increases stream resistance, raises river stage and nearby groundwater levels and so alters groundwater – surface water interactions (Jones et al. 2008).

An example of the two step procedure is illustrated in Figure 9.12 for the River Piddle in Dorset where the trout fishery appeared to be damaged by groundwater abstractions. A catchment scale groundwater – surface water model was used to calculate the locations and magnitude of groundwater discharges to the river, and these results were then used in PHABSIM to estimate the changes in habitat suitability. The quality of the results was sufficient to justify a change in the abstraction licence and put compensation water into the river.

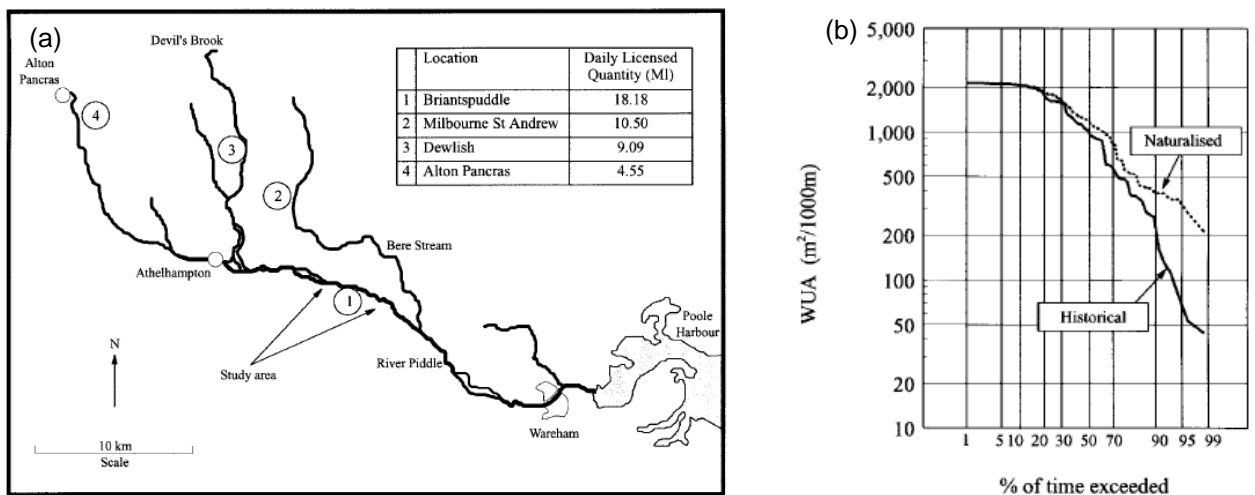

Figure 9.12 Use of loosely coupled models to investigate the effect of groundwater abstractions on fish habitats in the River Piddle, Dorset. (a) Location map with major groundwater abstractions (1-4) and study reach. (b) Duration curves for WUA (weighted useable area, a measure of habitat availability) with and without historical abstractions (Strevens, 1999).

9.3 Conclusions

Most modellers would argue that the primary benefits of modelling are to bring clarity of thought and to integrate all the information about a question. Models can also be used to quantify processes and effects, make predictions and give some understanding of uncertainty, but these benefits are less easy to realise.

The review above indicates that modelling tools are available to help analyse many aspects of the groundwater-surface water interface, but not all. The widest range of tools are for analysing flows and range from simple analytical models in easy to use spreadsheets to complex numerical models which require substantial amounts of data and expertise. A range of tools for analysing solute transport are available; some are focussed on groundwater, and others primarily consider the river. However the simpler solute models do not explicitly allow for the groundwater-surface water interface and the more complex ones require expertise and significant amounts of time to be useful. None of the readily available tools estimate the effects of the groundwater-surface water interface on ecology.

Table 9.1. Examples of flow modelling software for the main types of models used for groundwater - surface water interactions.

Model name, references, web resources	Model type, background & general theory
<p>RAM (Resource Assessment Methodology)</p> <p>Environment Agency (2002).</p> <p>http://publications.environment-agency.gov.uk</p>	<p>Model type: lumped</p> <p>RAM methodology developed by the Environment Agency of England and Wales and Entec UK Ltd to support assessments of resource availability in integrated groundwater - surface water systems.</p> <p>Spreadsheet water budget tool is used as part of the methodology to calculate scenarios representing recharge, abstractions, and discharges for Groundwater Management Units.</p>
<p>IGARF (Impact of Groundwater Abstractions on River Flows)</p> <p>Environment Agency (2004).</p> <p>http://publications.environment-agency.gov.uk</p>	<p>Model type: analytical</p> <p>The IGARF modelling tool was developed the Environment Agency and Environmental Simulations International as part of a scoping methodology to support assessments of groundwater abstraction license applications.</p> <p>IGARF is a spreadsheet that includes several models that represent the impact of abstraction from an abstraction well on flow depletion in one or two rivers.</p>

Model name, references, web resources	Model type, background & general theory
<p>MODFLOW groundwater model (McDonald & Harbaugh, 1988; Harbaugh <i>et al.</i>, 2000)</p> <p>Free software including source code available at http://water.usgs.gov/nrp/groundwater/software/modflow.html</p> <p>MODFLOW is usually run within one of the many commercial groundwater modelling graphical interfaces, see website.</p>	<p>Model type: numerical, physics based, spatially distributed, finite-difference</p> <p>MODFLOW is the most widely used groundwater modelling software, developed by USGS (United States Geological Survey). It is based on a multi-layered finite difference approximation of the 3D groundwater flow equations.</p> <p>Variants related to coupled groundwater-surface water models allow routing of river flows and feedback from river levels to exchange flows, including:</p> <ul style="list-style-type: none"> • DAFLOW: MODFLOW coupled with river flow routing model • MODBRNCH; MODFLOW coupled with BRANCH unsteady river flow module • GSFLOW: MODFLOW coupled with the USGS Precipitation-Runoff Modelling System (PRMS); • MODHMS; MODFLOW coupled with SURFACT, including 1D river and 2D overland flow • IHM: MODFLOW coupled with surface water model HSPF for full hydrological cycle
<p>ZOOM groundwater models</p> <p>ZOOMQ3D BGS (2004). www.bgs.ac.uk/science/3Dmodelling/zoom.html</p> <p>ZIGARF (ZOOM-IGARF) Environment Agency (2008).</p>	<p>Model type: numerical, physics based, spatially distributed, finite-difference</p> <p>ZOOMQ3D was developed by British Geological Survey, Birmingham University and the Environment Agency as a nested modelling system that can represent local effects within a regional scale model.</p> <p>ZOOMQ3D uses an integrated finite-difference method on a nested grid to solve groundwater flow equations. Additional compatible models have been developed to represent other aspects of the hydrological system, including recharge estimation. An interface has also been developed (ZIGARF) to allow the model to be used to simulate the impact of abstractions on stream flows.</p>

Model name, references, web resources	Model type, background & general theory
<p>MIKE-SHE integrated catchment modelling system</p> <p>http://www.dhigroup.com/Software/WaterResources/MIKESHE.aspx</p>	<p>Model type: numerical, physics based, spatially distributed, finite-difference</p> <p>MIKE-SHE is commercial software from the Danish Hydraulic Institute (DHI) based on the Système Hydrologique Européen (SHE) modelling system, which was developed in a joint European project.</p> <p>MIKE-SHE represents all components of the hydrological cycle based on a finite-difference grid, with surface and groundwater flows linked through one-dimensional unsaturated zone. The model can be coupled to other well-known software including Mike-11 for hydrodynamic river flow modelling.</p>
<p>SHETRAN integrated catchment modelling system</p> <p>Ewen et al. (2000)</p> <p>www.ceg.ncl.ac.uk/shetran</p>	<p>Model type: numerical, physics based, spatially distributed, finite-difference</p> <p>SHETRAN was developed by Newcastle University based on the Système Hydrologique Européen (SHE) modelling system, which was developed in a joint European project.</p> <p>SHETRAN represents all components of the hydrological cycle based on a finite-difference grid, with an integrated variably-saturated subsurface flow for the saturated and unsaturated zones. SHETRAN V4 has been widely used for problems involving integrated flow with sediment or contaminant transport. SHETRAN V5 includes local mesh refinement and integrated flow and heat transport.</p>
<p>Hydrogeosphere integrated surface-subsurface model</p> <p>Therrien et al. (2004)</p> <p>http://www.science.uwaterloo.ca/~mclaren/public/hydrosphere.pdf</p>	<p>Model type: numerical, physics based, spatially distributed, finite-element</p> <p>Hydrogeosphere is a finite element model for simulating integrated surface-subsurface flow and transport, developed by the University of Waterloo. It represents all of the components of the hydrological cycle, with a similar representation of stream-aquifer interactions as the MODFLOW variants and the SHE models. It includes capabilities for flow through fracture networks and contaminant transport.</p>

Model name, references, web resources	Model type, background & general theory
<p>INCA integrated catchment model</p> <p>Environment Agency (2006)</p> <p>http://www.reading.ac.uk/INCA/pages/methods.htm</p>	<p>Model type: numerical, physics based, semi distributed</p> <p>INCA consists of a suite of models of water quality in catchments, developed by the University of Reading and others. It is a semi-distributed model, with water quality variables being calculated in landscape units and fed into a river model. Specific models in the INCA family include Nitrogen, Phosphorus and Carbon, sediment, and toxic elements.</p>
<p>Otis river quality model</p> <p>Runkel (1998)</p> <p>http://smig.usgs.gov/cgi-bin/SMIC/model_home_pages/model_home</p>	<p>Model type: numerical, physics based, spatially distributed, finite-difference</p> <p>OTIS is a one-dimensional model of solute transport in rivers, developed by USGS. Transport is modelled using the advection-dispersion equation along the stream, with temporary (transient) storage of solutes in river bed sediments and banks. It is a widely used example of a Transient Storage Model. Interaction with groundwater is not explicitly modelled, with only local near-river storage processes being represented.</p>

10 Groundwater-surface water interactions and River Restoration

10.1 Introduction

Legislation such as the European Water Framework Directive (WFD) requires nations to take an integrative approach for management of their waters. The directive aims to prevent further deterioration of nations' waters as well as encourage improvement in the status of water bodies and their associated ecosystems. These status measurements are a combination of chemical limits and ecological indicators including fish, macrophytes, macroinvertebrates, and diatoms. Attaining good chemical and ecological status for both surface water bodies and groundwater bodies is one of the primary goals of the WFD. If interaction between surface and groundwater bodies results in one not meeting 'good' status requirements, then the other associated water body fails as well, and programs must be put into place aimed at improving the status (CEC, 2006). These objectives make it clear that activities that have an impact on the GW/SW interaction have the potential to impact the WFD water body status requirements. As river restoration is one way of helping to re-establish 'good ecological status' of river systems, we hope to address how these activities can affect groundwater/surface water (GW/SW) interactions and how knowledge of these interactions and the ecology of the hyporheic zone ecotone may better inform restoration actions.

Various authors have indicated the importance of addressing the hyporheic zone in river monitoring (Smith et al., 2008; Boulton, 2000) and restoration schemes (Boulton 2007). For example, recent research has shown that the direction of GW/SW exchange influences the benthic community composition and abundance in streams (Davy-Bowker et al, 2006; Pepin and Hauer, 2002). This demonstrates the importance of understanding the exchange processes to ensure ecologically valid results for river monitoring schemes. Several authors have discussed how examining the hyporheic zone in relation to riverbed remediation schemes has helped to identify areas of failure and directly indicates the need for knowledge of whole system inputs when determining where to implement a restoration scheme and what type of action is most likely to yield favourable results (Kasahara and Hill, 2007).

The river substrates provide important habitats for diverse communities both above and below the surface of the riverbed. Chapter 6 discusses these habitats and their inherent ecology, including rearing areas for early insect instars, providing flow and temperature refugia, and acting as a source of additional nutrients and an area of pollutant attenuation. The hyporheic zone is an important habitat in its own right and consists of a unique faunal community. A key area of interest in groundwater exchange for river managers relates to salmonid spawning. Recent research has shown the importance of GW/SW exchange in redd success rates and fish productivity (Malcolm et al., 2008). Water temperature plays a major role in determining development and emergence time of aquatic organisms and the contribution that groundwater exchange can have on surface waters has already been discussed. Therefore it is reasonable to suggest that the success of restoration activities designed to improve spawning habitat may be influenced by GW/SW exchange.

This chapter discusses the potential impacts of river restoration on the hyporheic zone and GW/SW processes. It focuses on three key questions (below) but recognises that these restorative actions will often be related to other activities such as flood risk objectives or wider river management requirements.

Key Questions:

- How do restoration actions affect GW/SW interactions?
- How can GW/SW exchange influence river restoration actions?
- Is GW/SW exchange important in river restoration?

10.2 What is River Restoration?

There are numerous definitions for 'river restoration' but generally this is used as a generic term to mean anything from full scale restoration (which is rarely obtainable) to small scale habitat enhancement projects for a specific species (Wohl et al., 2005). In areas where the overall system has been relatively unaffected by human manipulation, goals for a restoration project may be able to return a damaged section of river to an almost natural state (for example, replacing an undersized culvert in a remote wilderness setting where the rest of the system is intact). However, in reality most river restoration actions take place in heavily modified catchments. In England, for example, the majority of the waterways have been altered due to thousands of years of habitation and many watercourses have undergone multiple changes in form as they have been channelised, impounded or rerouted. Restoration actions in these systems can aim to restore river processes and ecological functioning, but only within the remit of today's constraints and hydrological regime.

In this chapter, we will focus on river restoration examples in the United Kingdom. However, many core principles remain the same wherever restoration schemes are being implemented, when discussed in the context of the hyporheic zone. As well, it is important to note that much of the research in river restoration and hyporheic process has occurred in other countries (America, New Zealand, Switzerland, France, etc). It is also recognised that there are many manuals for, and critiques of, river restoration practices. The River Restoration Centre (RRC), for example, has produced a manual for guiding restoration activities in the United Kingdom, which focuses on a series of case studies that demonstrate what they consider to be good practice. Examples for this chapter will lean heavily on this manual and knowledge held within that organisation.

10.3 Review of River Restoration

River restoration is a complex subject that affects not only the users of a watercourse but also the land management and natural ecology within a river catchment. Most rivers and floodplains in Europe have been severely degraded over a long period of time, which has serious implications for both ecology and river flow. Table 10.1 illustrates a few human manipulations of river systems and their potential impacts on the hyporheic zone. Postel and Richter (2003) explain that natural river flow is a key element in sustaining a healthy river system, including absorbing pollutants, decomposing wastes, producing fresh water and the redistribution of sediments and habitat replenishment during floods. When considering the GW/SW interactions in this context it is clear that many key river functions are directly affected by hyporheic process and similarly affect the hyporheic zone when they are altered. River restoration or river enhancement schemes cannot simply imply a return to some previous river state (e.g. re-meandering based solely on historical planform location evidence) with

the assumption that this will be a sustainable solution without any future management or intervention. Instead, river restoration needs to focus on establishing self-sustaining systems (Nilsson and Malmqvist 2007), where possible, based on current and predicted climate regimes and associated flow dynamics. It should also recognise that floodplains (resulting in lateral hydraulic conductivity) are an integral part of the natural functioning of the riverine environment.

Table 10.1 Potential direct and indirect effects of various management activities on hyporheic processes (from Edwards (1998)).

Activity	Direct ecosystem response	Indirect hyporheic response
Dams	Reduced maximum discharge, altered flood frequency and timing reduced sediment transport, altered temperature regime	Reduced subsurface flows, reduced extent of hyporheic zone, lower oxygen concentrations, less fine sediment flushing, reduced interstitial space, lower dissolved and particulate organic matter (DOM and POM) inputs, reduced secondary production
Forestry	Decreased input of large woody debris, increased coarse and fine sediment input, altered riparian vegetation	Changes in distribution and volume of hyporheic zone, altered riparian soil chemistry, altered riparian nutrient inputs, changes in stream primary production
Agriculture	Elimination of riparian vegetation, groundwater withdrawal, fertiliser applications, pesticide inputs, diking, channelization	Alterations on riparian soil organic matter and nutrient stocks, elimination of riparian habitat, reductions in hyporheic flows, reversals of subsurface flowpaths, elimination hyporheic zones, reduction in invertebrate production diversity
Urbanization	Changes in hydrology, increased fine sediment inputs, increase organic loading, toxic material inputs, increased flood magnitudes, channel incision, reduced riparian zone	Elimination of hyporheic zone, anerobic conditions, reduction or elimination of hyporheic fauna, shift to undesirable fauna, reduced biodiversity and production

River systems are dynamic bodies that continuously change as a result of their inherent physical characteristics, such as slope, geology, bedrock, and geographical location, together with external catchment factors, such as urbanisation, afforestation, deforestation, land drainage and flow regulation (Mant and Janes, 2006). The variations of these factors mean that the scale and type of action/intervention that is appropriate to achieve a given set of biological or physical restoration aims can vary considerably. Chapter 3 discusses how geomorphology can be contextualised in terms of nested spatial scales (Newson, 2006) and the same can apply in terms of river restoration scales. For example, catchment scale restoration might focus on longitudinal river connectivity for fish passage through the removal of weirs which can have a direct impact of sediment transport and channel hydraulics, whereas reach scale enhancement measures such as the introduction of gravel or manipulation of the channel dynamics to create pool-riffle sequences are more likely to have an impact on

local up and down-welling and local velocity distributions necessary for ecology and especially for fish habitats (see Chapter 5).

The rationale for implementing river restoration measures varies geographically, as a result of historical legacy, local institutional and stakeholder decision making processes, and with watercourse type. Thus, the type of restoration action considered for a site varies depending on many different local factors and scenarios.

10.4 Scale of implementation and impact

It is important to recognise the scale of impact that restoration actions will have, both laterally (i.e. reconnection to the floodplain) and longitudinally, in terms of hydro-morphological and ecological processes and benefits. Many actions are site specific and address localised habitat issues with little wider benefit (e.g. berm creation) (Harrison et al., 2004), however other actions may occur at a local scale but provide larger scale benefits or impacts by restoring connectivity (e.g. weir, dam or flood bund removal or lowering). However, catchment-scale restoration activities generally need to interface with a more policy-based approach. Catchment Sensitive Farming (CSF) is one initiative that results in actions aimed at reducing fine sediment loads and diffuse pollution to aquatic systems. Where in-channel restoration is linked to such initiatives, benefits can often be significant scaled up. More recently the River Basin Management Plans, required through the WFD, provide a driving force for working towards catchment scale restoration opportunities.

10.5 The need for physical, hydrological, chemical and biological integration

Most river restoration projects in the UK include aspirational objectives to integrate physical, hydrological, chemical and biological aspects of the system. However, these objectives are rarely sufficiently focused. It is generally recognised that river restoration requires a set of objectives against which the outcomes can be measured (England et al., 2008) yet this is often overlooked. This may in part be because there are very few guidelines to help support the decision making processes in terms of the physical aspects of river restoration or linking these to chemical, hydrological or biological benefits.

Indeed Reicherts et al. (2007) note that river restoration decisions are often taken without sufficient transparency about different goals or predicted project outcomes during the decision making process. River restoration projects either seek to improve the biotic element through the abiotic processes or to improve abiotic processes on the assumption that this will lead to better biotic elements (see Figure 10.1). Whether one approach is more effective than the other remains a source of continued debate and is dependant upon the previous management and interference with the watercourse, as well as how feasible it is to 'restore' a river back to more pre-disturbance state. What is important is to encourage river restoration decision makers to think about how to integrate these key elements within the context of hydrology and chemical (water quality) elements. For example, if leading from a biotic standpoint, what specific habitat function is necessary and how can that be achieved through the physical processes? Habitat for adult brown trout might be significantly different to those required for spawning or fry, and thus restoration targets must take into account the users of the area being restored before site and project selection. This is an area where consideration of GW/SW interactions can affect the entire conceptualisation of restoration planning. As the field of groundwater and hyporheic ecology has developed closely with the study of hydrogeology and the hydrologic and chemical exchanges

between ground and surface water bodies, the impacts of restoration in this zone can be assessed as a whole rather than physical versus biological.

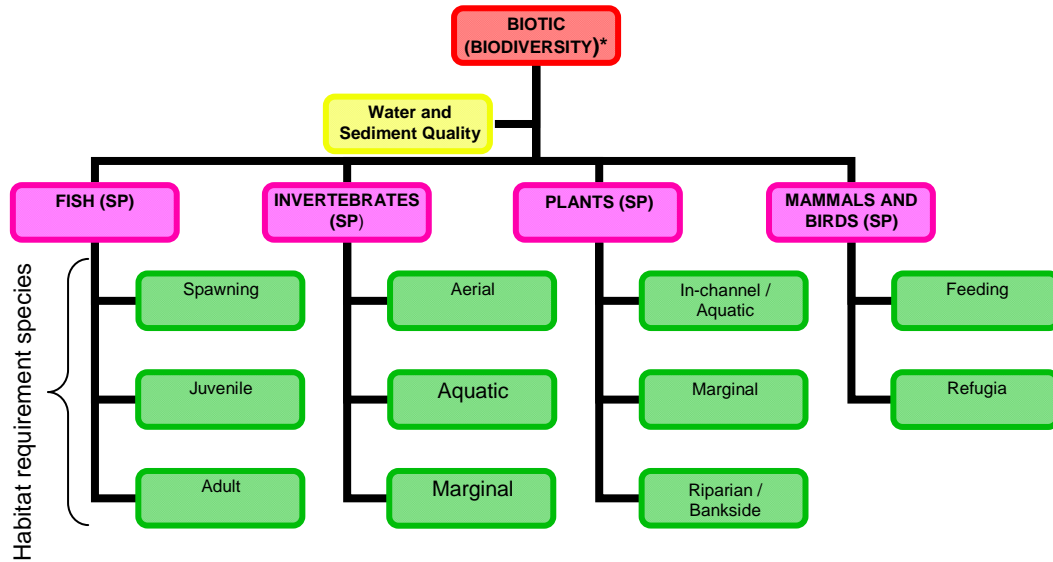

* Water Quality must first be considered before focusing on Fish, Invertebrates, Plants, or Mammals and Birds.

Figure 10.1 Diagram explaining habitat requirements for biotic variables used to monitor biodiversity.

10.6 What are the key processes used?

As discussed above, river restoration can be driven through a range of motivations. Whilst habitat restoration, especially at the reach scale, has historically been the driver in the UK, in other countries the focus of attention has been restoring physical and associated hydraulic processes by manipulating form, often to create more natural local storage of water on the floodplain (Gillian et al., 2005). With the implementation of the WFD, ecological status has become a key aspect. It is now recognised that river restoration should go beyond the manipulation of flows by implementing geomorphologic principles or localised habitat gain, and that water quality is a central component to address both through in-channel and associated floodplain measures. Thus the link between floodplains and rivers has become more prominent, which in turn highlights the importance of understanding hyporheic zone processes in this context.

10.7 Influences of river restoration activities on GW/SW exchange

Most river restoration activities are not implemented with GW/SW interactions in mind. The impact that river restoration work has on GW/SW exchange depends on the degree to which subsurface flows are affected. Increasing sinuosity and changing the retention-time of water within a section of river will generally increase the probability that surface and subsurface flows will mix (Kasahara and Hill, 2007). Whenever there is a change in the hydraulic head difference of the subsurface to surface water levels between two points in the system, there is a change in direction and/or intensity of

subsurface exchange. The impact of river restoration activities on the ecological processes in the hyporheic zone is generally driven by the degree to which the hydrology and chemistry in the exchange zone have been affected.

River restoration actions have multiple forms. According to the data held at the UK's River Restoration Centre, UK river restoration actions commonly include techniques such as narrowing, bed raising, sinuosity, riffles, bank removal/displacement, large-wood/instream deflectors, and weir removal (see Table 10.2). Many of these are related to river-floodplain reconnection and altering flow patterns. Weir removal is perhaps an interesting outlier in this suite of techniques since it has its own set of issues including the impacts on/from GW/SW interactions and is performed to increase longitudinal connectivity rather than lateral or vertical.

Perhaps one of the most commonly applied restoration techniques is the placement of in-stream structures for the purposes of increasing stream habitat heterogeneity. Following the principles described in Chapters 3 and 4, the placement of an obstacle in the stream will generally result in a localised increase in connectivity between surface and streambed water. Lautz and Fanelli (2008) demonstrated this when examining exchange properties around a 15 year old log weir and found various exchange patterns directly related to the weir placement.

10.8 Flood alleviation schemes and climate change

The current theory on climate change is that precipitation events will be more dramatic in the future with less predictable timing. The flooding events of the summer of 2007 raised awareness of the implications of such a change in weather regimes. These events also renewed interest in designing reliable flood defence schemes. The requirements of the WFD, however, prevent managing bodies from simply building higher and higher flood defence strategies and more recent analyses discussing the potential catastrophic results of failure of such schemes (Vis et al., 2003) have encouraged land managers and regulating agencies to look for alternative strategies that are both more ecologically compatible and of lower risk of catastrophic damage.

In extreme precipitation events, groundwater flooding adds to the fluvial flooding concerns (Cobby, 2009). Thus knowledge of potential preferential subsurface flow paths under such conditions may help in planning flood protection. It is clear that simply attempting to move water downstream is not a feasible solution for entire settled catchments. Here is where flood-alleviation and river restoration are often paired. Creation of storage areas upstream of an area of concern may include such actions as repositioning a dike away from the edge of the river such that the river has room to expand during high flow events and thus decrease the peak flows downstream. This partial return of the flow to the original floodplain also increases the habitat diversity of the river ecosystem and increases the subsurface hydrological linkages between groundwater and surface water. The treatment of the floodplains can have further ecological benefits, creating temporary wetlands and floodplain forests (Horn and Richards, 2007) with subsurface water dependence, further reconnecting the river to its surrounding environment.

These and other adaptive management strategies for flood alleviation allow the system to adjust to altered flow conditions and provide a buffer for downstream populated areas where it may not be as easy to accommodate the flexibility of the watercourse. Additional care may also be necessary when planning river restoration activities in relation to groundwater flows and requirements for water extraction. Increasing subsurface storage may be preferable to simply transporting water downstream as climate patterns become more unpredictable.

10.9 River restoration actions and possible implications for GW/SW exchange

The following section details river restoration methods used by the RRC. A brief description of possible impacts on GW/SW exchange follows each description. The aim of this section is to inform practitioners of some general restoration strategies and the implications of those activities on GW/SW exchange and processes.

Table 10.2 UK River restoration techniques and their possible impacts on various factors of the GW/SW exchange.

Restoration action	%	Impact categories						
		Hydrology	Chemistry	Sediment	Microbiology	Invertebrates	Fish	Plants
Local flow manipulation (instream deflectors/ large-wood)	43	Local increase in exchange	Increase in flow- >increase in O ₂ , organics	Localised redistribution of sediment	Localised change in communities due to sediment distribution	Localised change in community due to flow and habitat,	Spawning in tailout, refuge in pool	Localised algal and macrophyte colonization
Bed raising/substrate imports	8	Local increase in exchange in surfaces/subsurface flow	Increase chemical transformations depending on residence time	Immediate increase in gravel bed depth, possible increase in floodplain deposition	Large substrate may decrease biofilm surface area; increase bed depth provides localised habitat	Recolonisation period, substrate/flow dependent	Spawning areas, success dependent upon water quality and flow	Removal of existing aquatic flora, shift in morphotype and possibly species
Reconnection to floodplain	1	Increased residence time of subsurface flow	Increased surface transformation, increased interaction between GW and SW	Larger scale redistribution of sediment, deposition to, and recruitment from channel	Increased heterogeneity, increased residence time, increases biological interactions	Increased habitat availability redistribution across habitats	Off channel habitats, subsurface flow refugia	Ground water dependent terrestrial plants have increasing water availability
Sinuosity	6.5	Increased residence time of water within reach and localised subsurface flow	Increased residence time and opportunity for chemical reactions	Redistribution of sediment, increasing opportunities for variation in gravel bed depth	Microbiological activity, may increase with increase in stream-affected sediment	Increase area available to invertebrates and diversity of habitats	Generally increase in habitat diversity; may alter species compositions	Increased lateral subsurface exchange; more opportunities for riparian vegetation
Riffles	4.5	Pool-riffle scale alteration in flow	Localised change in water chemistry	Localised redistribution, possible change in erosion potential	Localised. Possible Increased exchange will impact anaerobic/aerobic contributions	Localised increase in riffle-associated organisms	Localised increase in food source, localised spawning opportunities	Aquatic vegetation will shift to riffle habitat
Deculverting	3	Surface water access to substrate and	Increase in chemical exchange as water	Redistribution of sediment from previously	Shift from terrestrial subsurface to aquatic subsurface	Terrestrial soil fauna shift to hyporheic fauna and	Increased habitat area and longitudinal connectivity	Increasing access to subsurface and surface water

		ground water. Change to gradual shift in hydraulic head	interacts with substrate	confined system	processes	benthic fauna	, access to local subsurface flows	sources. Riparian vegetation
Weir removal	6	Change in hydraulic head, change from lentic to lotic water features	May increase exchange processes and decrease residence time	Redistribution of sediments and fines upstream and downstream	Shift from lentic to lotic hyporheic processes	Shift from lentic to lotic community	Shift from lentic to lotic communities, increase longitudinal connectivity	Shift from lentic to lotic, increase habitat variability
Removal of artificial banks and bed	5	Increase subsurface exchange	Localised increase in chemical transformation	Increase natural sediment scour and deposition	Add subsurface microbiology to surface processes	Provides increase in vertical and horizontal habitat	Increase flow variation, spawning habitat	Change in community structure from shallow to deep roots
Fish cover enhancements (e.g. riparian and/or in-stream planting)	18	Localised alteration in flow.	Local change in chemical exchange	Alter local depositional patterns	Localised alterations	Localised community change due to change in resource	Localised increase in use of area	Change in community, increased subsurface water use

10.9.1 Local flow manipulation

The majority of restoration actions in the UK have historically focused at the local scale and deal with local flow manipulation. These projects usually focus on a few hundred meters of river at the most and are aimed at enhancing river habitat in a specific area. Such action may be done in co-operation with other restoration activities or singly, depending on funding, interest and regulatory requirements/restriction. Many waterways have been over-widened for industrial or agricultural purposes to reduce local flooding and rapidly evacuate water downstream. This past management can lead to very sluggish flow within the reach, with a deposition of fine sediment and very little channel morphological or habitat diversity. Numerous methods are employed to return stream channels to a more natural width. These include:

- *Stream narrowing: Willow mattresses*
This type of technique tends to concentrate the main flow of water to the centre of channel. Mattresses usually consist of interwoven brush tied into the bank of the river (Figure 10.2) and should be placed at summer water level to form a low flow channel and encourage sediment deposition by increasing roughness and ultimately the growth of vegetation at the margins (Figure 10.3).

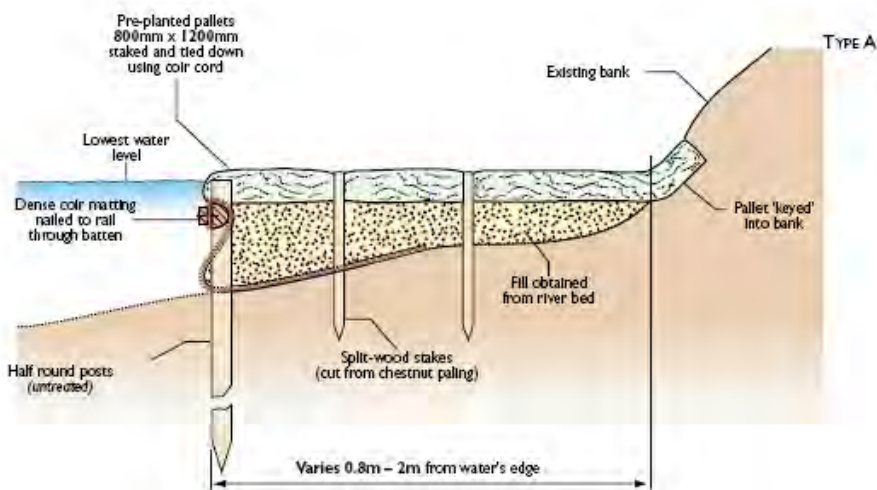

Figure 10.2 Diagram of type A design for aquatic ledges used in stream narrowing (From RRC, 2002).



Figure 10.3 River Skerne after river narrowing with type-A vegetation ledges (from RRC river restoration manual).

- Large wood/in-stream deflectors*

Large wood and in-stream deflectors may be added to either protect riverbanks from exacerbated erosion that is occurring in an unacceptable location or increase flow diversity and in-channel cover for habitat measures. Methods of installation vary depending on location and rationale for use (Brookes, 2006). In populated areas, wood is generally 'fixed' using chains, stakes, concrete blocks, and/or cables, to ensure that material is not transported to areas where it might create hazards and/or increase flood risk. In less populated areas, more natural approaches may be appropriate such as designing in-channel large wood 'debris' to provide an initial framework on which other wood can collect depending on natural flow dynamics and 'seeding' the floodplain to ensure a future supply of wood.

CASE STUDY: Installation of large wood. Highland Water (New Forest, Hampshire, UK)

As part of the 'Sustainable Wetland Restoration in the New Forest' LIFE 3 project, a range of restoration work took place in 2004/2005 at this site. The design and installation of large woody structures, in conjunction with raising the bed, formed a significant part of the project, which aimed to reduce flow rates, create local morphological diversity and encourage seasonal flooding onto the surrounding floodplain (Figure 10.4).



Figure 10.4 Large woody debris added to a stream (From RRC, 2002).

- *Boulders*
In some cases (such as high energy gravel bed rivers where opportunities are constrained by anthropogenic influences) a more appropriate technique may be to embed large boulders into the bed, to create a variety of flow velocities.

CASE STUDY. Boulder bed – Inchewan Burn

Inchewan Burn flows through the village of Birnam, Scotland. When the village was bypassed by the A9, a reach of this burn became encased in gabion basket on the banks and a reno mattress was constructed on the bed. Due to the high energy environment, the mobile coarse bed load which continued to travel through this reach, soon abraded the protective PVC and galvanised coating of the Reno mattresses resulting in a section that was impassable to fish as the river began to down cut and the wire unraveled along the bed (Figure 10.5a). An opportunity therefore arose to restore this section, yet with the aim of keeping its structural integrity through mimicking a 'natural' section of the burn by anchoring large rocks and stones into the channel bed to create a step-pool type reach (Figure 10.5b). This created a system that, whilst partially engineered, could work with the natural sediment transport system through the reach.



Figure 10.5 Case study of boulder placement restoration. a) before restoration activities, b) after boulder placement (from RRC).

Impact on GW/SW interactions

Addition of structures into the river bed will cause localised alteration in vertical flow dynamics. Studies on the changes in biogeochemistry and flow patterns in response to restoration activities involving large woody debris have demonstrated these localised effects (Kasahara and Hill, 2006). Knowledge of river properties as they relate to GW/SW exchange can enhance the success of these projects when targeting increasing exchange, as was shown by Hester et al. (2009) where they determined the greatest benefit of increasing GW/SW exchange for water cooling effects was attained when structures were used in coarse gravel bed settings

10.9.2 Bed raising

Excessive erosion and dredging can lower a bed far below its natural level. These incised channels lose economic, ecological, and social functions. Raising the bed helps reconnect the terrestrial and aquatic systems and offers a more suitable habitat to many organisms. However, it is often a costly process in all but localised reaches. The preferred option is to raise the bed by installing a new gravel bed of appropriately sized sediment of the right geological type, which at the same time can create some in-channel features. Often this is achieved by installing short riffle type runs where back water effects are clearly visible upstream of these features. An alternative is to place a series of low 'weir' type structures, especially in situations where downcutting is the key river process of concern, to encourage local sediment depositions and check the bed scour.

CASE STUDY. Bed raising through low weirs – Tilmore Brook

This brook flows through Petersfield, Hampshire and had been straightened and deepened historically. Since the 1960s there has been a series of building work as the surrounding housing estate increased in size. Local 'ad hoc' bank protection caused the brook to start down cutting and there was associated bank erosion. To compensate for this steep gradient and to retain bed material, a step/pool arrangement was introduced using a series of limestone slab weirs, controlling and reducing the energy of the water at specific locations (Figure 10.6).



Figure 10.1 Photos of step-weir placement a)looking upstream, b)looking downstream.

Impact on GW-SW interaction

Bed raising and substrate placement will have obvious impacts on the surface-groundwater interaction zone as it creates a greater volume of material through which the water will flow through. In areas where there is no direct interaction with groundwater, the increased bed material can still result in localised subsurface flows of river water. This then provides a larger area in which subsurface organisms can inhabit and biogeochemical processes can occur.

10.9.3 Sinuosity

Human activities along rivers and their floodplains have often led to channel reconfiguration and in many cases this has resulted in straight, non-sinuuous waterways to enable expedited transport of discharge. Such modifications reduce habitat variability and ecological functions and the river has less interaction with the surrounding floodplain. Re-meandering straightened channels provides an opportunity for more natural geomorphological processes and corresponding ecological diversity to occur. In some cases it may be feasible to identify old channels where the river previously flowed and this can be used either as a template for the design of a new channel, or to reconnect the river back to the old route.

Impact on GW/SW interaction

Sinuosity in a river channel, where appropriate within a catchment, generally provides greater lateral subsurface water exchange by slowing down the rate of flow locally, although this interchange is also dependent upon an appropriate bed level (i.e. limited or no dredging to deepen the channel). The area between bends in a river becomes infiltrated by subsurface flows taking different flow paths to next point of surface water. Groundwater sources may interact with these subsurface flows, creating unique off-channel subsurface habitats. In addition riparian vegetation may benefit from increased subsurface water sources.

10.9.4 Pool and riffles sequences

In many cases where a river has been dredged, the pool and riffle sequences have been lost. The longitudinal profile has been 'smoothed' out and the gravels removed from the bed of the river, resulting in a homogenous run-type channel with very little flow diversity. This represents a major loss of habitat for a range of invertebrates and fish. In heavily modified rivers, natural regeneration of these features is often hampered where sediment transport is prevented because of constrained banks and bed resulting in a lack of natural substrate. A combination of manipulating the long profile, through the introduction of locally sourced gravels, and other flow manipulation techniques can provide the river with some of its original form and function. It is important to use

appropriately sized sediment for maximum benefit. While artificial riffles are more permanent, this very fact can result in less ecological function and a need for more persistent maintenance.

CASE STUDY. Fish spawning and siltation - Hempton, River Wensum, Norfolk

As part of a 3-part flood risk management scheme, ecological mitigation work was completed at this site which included construction of riffles which had a dual purpose of diverting part of the flow through a restored meander loop but also to create spawning habitat (Figure 10.7). Additional riffles were installed along the main river for habitat enhancement purposes. However, after a few years the new riffle gravels became 'concreted' in places due to accumulation of large amounts of fine material transported to the site from upstream areas of the catchment. Whilst this riffle may continue to provide some flow variation locally, it is doubtful if, in this condition, it would sustain fish redds or macro-invertebrate communities and furthermore without some maintenance will have an impact locally on hyporheic processes.



Figure 10.2 Constructed riffle case study (from RRC).

When constructed riffles are created in conjunction with bridge protection, the underlying surface may be concrete with a surface roughened with stones to encourage gravel deposition. More natural riffle creation may involve the placement of gravel where the reach has been sufficiently denuded of suitable substrate.

Impact on GW/SW interaction

Creation of riffles may also be used as creation of spawning areas for fish. In such a situation, ability of the riffle to maintain a degree of subsurface flow throughout the incubation period is critical if it is to provide sufficient oxygen to the developing embryos. The shallower riffle construction can provide the required velocities for algae and benthic communities as well as allow for flow variation that can influence the subsurface exchange where the bed again becomes permeable.

10.9.5 Bund removal and reconnection to the floodplain

Throughout the history of human settlement, flooding has been a major concern. Construction of embankments prevents natural river migration and limits interaction of a river with its floodplain which has a major impact in fluvial process and wider ecological processes, especially in areas where there should be intermittent wetter areas for example together with the success of floodplain forest communities. As an alternative to flood-prevention strategies and in an effort to enhance ecological

processes, embankments may be removed or set back some distance from the existing riverbank. This will not only provide space for water, (Defra, 2004) but can potentially attenuate the flood peak with benefits for flood protection downstream and create more habitat and transfer of flows and recharge. An example of this practice is the Long Eau near Manby, Lincolnshire (Figure 10.8).

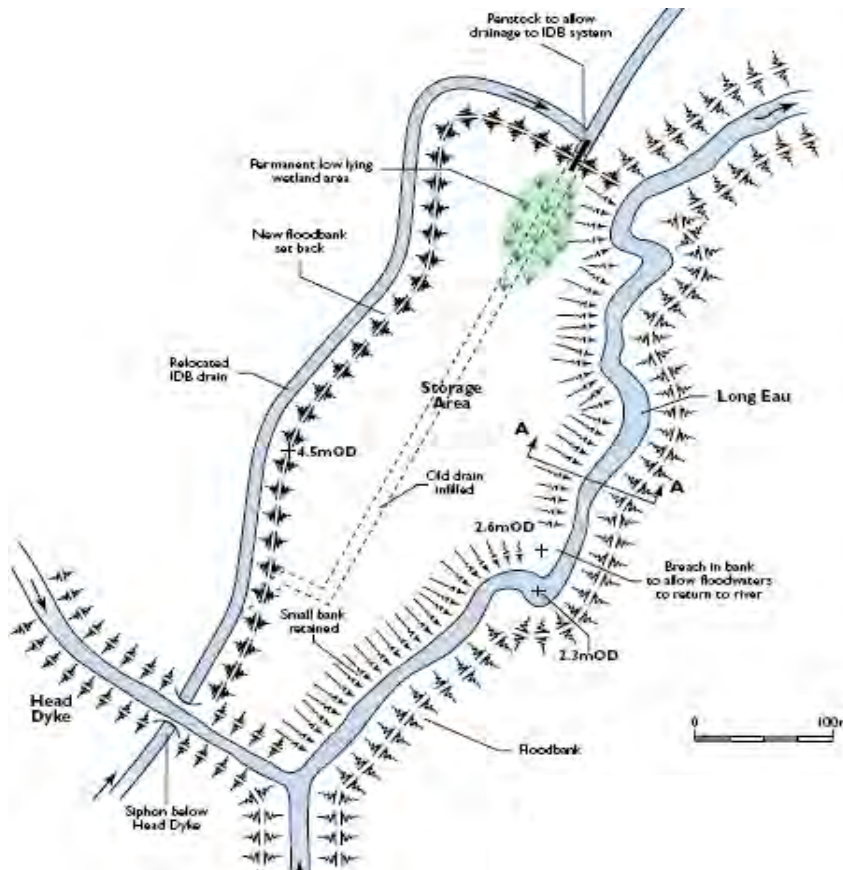

Figure 10.3 Schematic of bund removal and floodplain connectivity (from RRC restoration manual).

Here, the flood banks were set back from the waterway to allow the river to become a washland during high flow events. This has potential benefits to landowners downstream as water is given a longer retention time and more space to flow over before reaching downstream areas. Allowing the river more freedom of movement has also resulted in a shift from planebed trapezoidal channel to a more “natural” pool-riffle sequence. (see RRC (2002) point 6.3 for further details)

Impact on GW/SW interaction

Like adding sinuosity to a river, reconnection of a river to its floodplain provides more space for subsurface flow interactions. The natural lateral extent of a river into its banks has been well documented and potential benefits from interaction of surface flows through this environment are numerous. Allowing natural movement of the stream allows for substrate recruitment thus diversifying the riverbed environment. Biogeochemical processes are restored, flood plain vegetation benefits from both surface and subsurface flows, and the biota, both surface and subsurface, has expanded habitat. Floodplain reconnection in particular is an area where monitoring GW/SW exchange and the fauna associated with it can be used for assessing project success (Pess et al., 2005).

10.9.6 Removal of hard banks or bed

Many rivers in populated areas have unnatural banks that have been reinforced with concrete, bricks, stone or steel in order to maintain a determined flow path and allow for planning of other infrastructure. River beds may also be 'lined' for purposes of maintaining water flow and historical ease of clearing a channel. In some situations it may be feasible to remove these man-made banks and replace them with more environmentally sound alternatives that can provide both bank protection and some degree of ecological function. Such options are usually a composite of engineered structures, such as geotextiles, wire bound willow, or boulder bundles, interspersed with appropriate vegetation planting aimed at holding the structure and the bank together. Removal of hard beds, such as concrete-lined channels, can also be considered in some cases to allow for natural processes. However, it is essential to understand the structure of the material below the hard surface and put into place any necessary measures to both trap any unacceptable silt and ensure that the up- and down-stream bed profiles are correctly tied in.

CASE STUDY. Bioengineering - Brent at Tokyngton Park, London

Here the concrete banks (Figure 10.9a) and bed were removed and a newly meandering course designed that took account of historical information and current on-site limitations. On the outside of some of the meander bends where there were concerns that bank erosion may cause an unacceptable risk to local infrastructure if it was not stabilised. Crushed concrete from the old river banks was reused to stabilise the toe of the bank below water level and a mixture of stone, interwoven with live willow stakes, held in place with wire was introduced on the banks with the vision that the willow would take hold and stabilise the banks (Figure 10.9b). This technique was only used at the most vulnerable sections and was interspersed with non-reinforced sections where natural river bank processes could be sustained (Figure 10.9c).



Figure 10.4 Images from hard bank removal on the River Trent in London. a) concrete-lined channel before restoration, b) construction of riverbed and banks after concrete removal, c) natural vegetation and bank features.

More often, however, the course of the concrete-lined channel is abandoned and the river rerouted to a newly constructed channel that will allow for more natural fluvial and if possible floodplain processes and functions.

CASE STUDY. Quaggy at Chinbrook Meadows

This site was formerly enclosed in a concrete channel (Figure 10.10a). The restoration works, of which were completed in 2002, removed the river from its concrete channel and the river was cut into the park (Figure 10.10d) to following its path prior to channelization. Sufficient room was left along the river corridor to allow for natural adjustment and to act as a more natural floodplain (Figures 10.10b and 10.10c). In this case no bank protection measures were included in the project



Figure 10.5 Process of repositioning a concrete lined channel into a new riverbed, showing a) original concrete-lined channel, b) floodplain features in newly created channel, c) new channel floodplain connection, d) new channel cut through park.

Impact on GW/SW interaction

In all cases it is essential to work with both the hydraulic and fluvial process to ensure a successful restoration project that can benefit the hyporheic zone functioning. Removal of hard banks and beds will usually result in a dramatic increase in subsurface-surface flow interactions. Whenever streams are rerouted, it is important to have an understanding of the underlying sediments and geology such that subsurface flows can help maintain the channel rather than resulting in unexpected events such as the water seeping through a porous substrate and becoming entirely subterranean.

10.9.7 Culvert Removal

Culvert removal has been gaining popularity as old infrastructure degrades and the expense of replacing and maintaining culverted systems is realised. Day lighting long stretches of culverted streams provides opportunities for social, ecological, and economic incentives (Riley, 1998). While many small streams were initially culverted partially to reduce flood risks, more recent ideas on flood-risk management have suggested providing floodplain floodwater storage where locations allow prevents

transporting the problem elsewhere and possibly compounding the issue when the water runs out of places to be transported to. Removal of a long culvert requires extensive earth moving and re-creation of an open-water channel. An example of daylighting in England is the River Ravensbourne at Norman Park, Bromley. The stream was diverted out of a 300 meter culvert and into a newly created channel within a park environment (Figure 10.11).

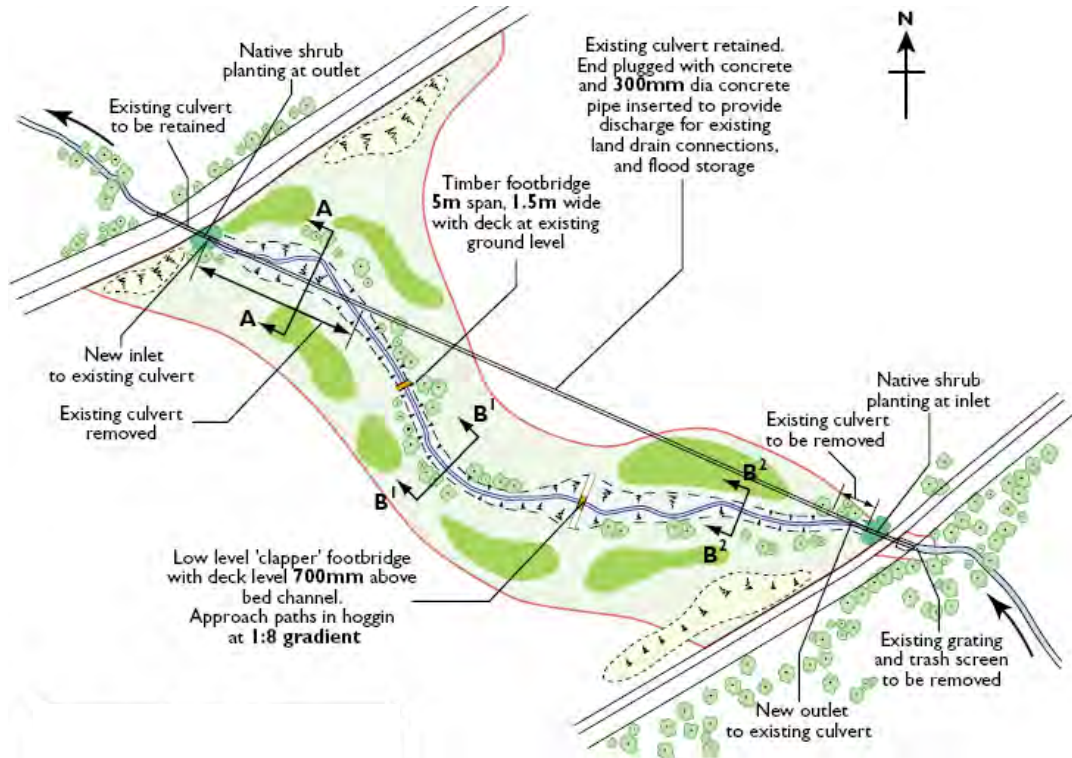

Figure 10.6 Schematic of culvert removal and new channel creation on the River Ravensbourne.

Impact on GW/SW interaction

Creation of new channels for waterways occurs in multiple restoration projects (increasing sinuosity, weir removal, hardened riverbeds, daylighting, etc). This is an area where knowledge of GW/SW interactions may inform the design and implementation processes. The potential for pollutant attenuation with increased subsurface habitat interaction as well as the benefits of various subsurface flows to the ecology could inform the project design. As well, knowledge of groundwater sources and what it means for groundwater to interact with the surface water environment and how surface activities may impact this interaction can provide additional information.

10.9.8 Tree planting

Where possible, restoration of a functioning riparian zone is often part of a restoration project mandate. Plantings help to stabilise banks and jump-start processes for continued benefits for riparian-river interactions. Allowing or assisting floodplain revegetation may be a desired restoration activity in itself, providing priority habitat types and restoring more natural bank-side conditions, both above and below ground. While tree removal has been a standard method of flood control in the past, targeting tree-planting in areas upstream of population centres could actually attenuate flood peaks for those downstream reaches (Horn and Richards, 2007). Tree planting can have dramatic effects on the availability of groundwater. Areas that have been denuded of trees in the riparian vegetation for extended periods of time may undergo dramatic

hydrological shifts as the trees take substantial quantities of water during their respiration cycle (Calder, 2007). Furthermore, in areas where soils have high nitrate concentrations, trees may result in increased nitrogen leaching to the groundwater. The planting of inappropriate trees can further exacerbate these issues (Calder, 2007) and therefore, care needs to be afforded in terms of the species that are planted.

10.9.9 Weir Removal

Maintaining and reintroducing natural longitudinal connectivity in stream systems is of great interest for many fisheries-driven projects as well as wider ecological restoration objectives. With the advent of the WFD this technique and fish passage options have become priority restoration actions since they have a major impact on the fish and the natural biotic and abiotic functioning of a river. Since weirs often result in the accumulation of sediment upstream of the structure, it is necessary to take precautions when removing weirs and, if needed, remove excess silt prior to work dredging to prevent re-mobilization, especially if the sediment is potentially contaminated. Weir removal will result in a degree of natural river adjustment and hydrological conditions, which in some cases will require steps to be taken to ensure bank stability is considered and potentially some narrowing techniques implemented.

Impact on GW/SW interaction

Weir removal comes with its own unique set of challenges. As the weir creates an artificial hydraulic head difference behind it, vertical hydraulic gradients will be altered after weir removal, probably altering the local patterns of vertical water movement between surface and subsurface water flows.

10.10 Reducing GW/SW exchange

Artificially 'lined' rivers

Many restoration efforts aim to increase connectivity, however, it must be recognised that in some cases this may not be a feasible or desirable course of action (Hick and Malqvist 2007). This may be the case naturally, such as segregation of spawning grounds by fish species due to their ability to overcome natural obstacles, or artificially, such as when subsurface flows are prevented from entering the watercourse by lining the riverbeds due to contaminated land or industrial uses. While the second example is rather drastic, it is a methodology that may be put into place especially in industrial and post-industrial sites.

10.10.1 Rerouting of watercourse over permeable substrate due to industrial actions

River Nith, in the uplands of south-east Scotland, was rerouted due to expanding mining operations (Figure 10.12). Because of the highly permeable substrata and industrial concerns, the river was lined to prevent the entire channel flowing subsurface and groundwater flooding in the mine site (Figure 10.13; RRC, 2002). This action prevents groundwater intrusion into the stream and limits surface-subsurface exchange to the local-scale. In this case, every attempt was made to maintain natural channel morphology with diversion reaching approximating natural reaches of stream above and below the diverted reach (i.e. pool-riffle morphology and appropriately-sized substrate).

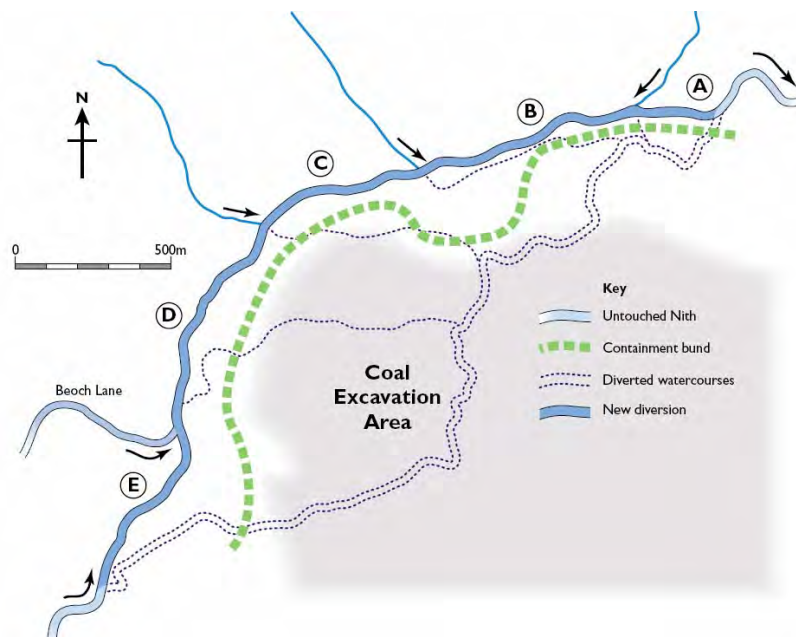

Figure 10.7 Diversion of a part of the River Nith away from expanding coal excavation (RRC 2007).

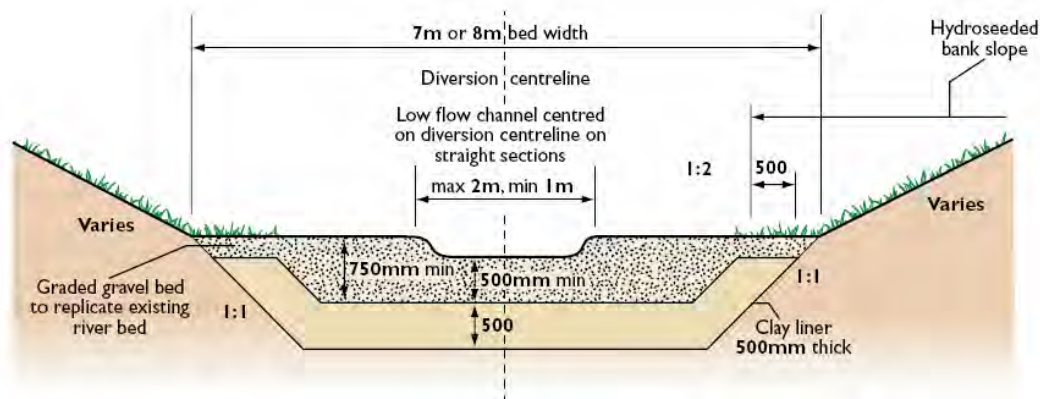

Figure 10.8 Typical symmetrical cross-section for River-Nith diversion and lined-channel construction (RRC 2007).

10.10.2 Poor surface water quality

Issues of surface water quality may be another reason for wanting to limit surface-subsurface exchange of a river with its surrounding aquifer. In areas of intensive agriculture and/or sewer discharge, contamination from stream water could have dramatic effects on aquifer ecology and water quality. In such a system, preventing interaction with groundwater may be a priority. Subsurface stream flow can still provide ecosystem services in such systems as the substrates above an impermeable barrier will still be biologically active and provide habitat functions for numerous organisms.

10.10.3 Contaminated Sediment

River restoration generally involves movement of river sediments. In some cases, such as weir removal, these sediments may be stored behind ecologically unfavourable structures. In their current state, the sediment may be relatively stable and immobile, however removal of the structure will re-suspend these sediments and expose contaminants to more biologically, and chemically active environments as well as

allowing them to propagate downstream (Bednarek, 2001). Direct approaches to dealing with contaminated sediment are to cap it (though this approach is rarely feasible in a riverine environment) or, direct removal of the contaminated sediment. Both methods result in a modification of the GW/SW exchange. The point of capping sediment is to prevent processes that would facilitate exchange of the sealed contaminants with the rest of the environment while removing contaminated sediments will result in a modification of the bed permeability (possibly increasing it depending on before and after substrate conditions) locally and thus change the GW/SW exchange pathways, which will subsequently change the associated biological and chemical exchange zones.

10.10.4 Poor Groundwater Quality

This is an area of great interest to land managers. The active exchange zone between surface- and groundwater resources has been shown to be an area of pollutant attenuation. High attenuation tends to rely upon long subsurface residence times and thus it is not likely to be a key process in more permeable substrates. However, it does indicate the importance of considering water sources before initiating streambed manipulation, whether for restoration, navigation, or flood mitigation purposes. As research progresses and we increase our knowledge of the attenuation processes active in the GW/SW interface, enhanced *in situ* remediation may become a tool in river remediation strategies.

10.11 Timescales and monitoring relative to the disturbance of the activity

The effects of projects aimed at stimulating natural processes may not be fully realised until well after funding and evaluation of success is completed (Roni et al., 2003). If, for example, actions are taken to reduce fine-sediment influx and stimulate sediment flushing when it does occur, it may take years of varying flows for the system to equilibrate such that the success of project implementation could be reasonably assessed. As well, if steps are taken to directly enhance the nutrient attenuation potential of a site, the community that is responsible for these functions must be allowed to develop. In addition to this, the effects of the restoration activity itself may cause initial negative results while the system recovers from a major excavation or construction work. Accounting for GW/SW interactions when determining how to minimise negative effects of disturbance from project implementation may be a way of improving project success. Just as silt collectors are placed in a river to minimise release of fines into the surface water, care should be taken to avoid undue disturbance to the GW/SW interaction zone, such as compaction of the subsurface.

The lag-time between action and ecological response can be difficult when working with one-time project funding sources. Funding is generally limited for any kind of post-project monitoring, let alone for years after completion. Legislation such as the WFD encourages a more integrated approach at managing water resources; actions aimed at improving those resources must then be aimed at being a part of the larger system as a whole.

10.12 Need for continued river management

River restoration projects in areas of extensive human habitation will generally require management of some kind. While we can make significant attempts to improve habitat and physical functioning of river systems, it is necessary to recognise that most rivers have been significantly altered over hundreds of years. Therefore, it would be a

mistake to assume that a single restoration activity will result in a sustainable river that can 'heal' itself without additional intervention. Project success can be significantly influenced by whether or not 'adaptive' river management and maintenance is carried out after the completion, as well as the timescales of such future interventions (Palmer, 2005). For example, a gravel-cleaning operation, where fine silt has accumulated within the interstices and has reduced the area as a functioning spawning habitat, will increase vertical hydraulic exchange in the short term but then decrease as the fine material enters the riffle once more (Meyer et al., 2008). Without additional actions to reduce the fine-sediment runoff, the project will not serve any long-term goals. It is now recognised that the success of many river restoration projects is dependent upon its context within wider catchment issues and understanding. Often this is related to assessing the sediment load (especially fine sediments, whether from road run-off or inappropriate farming practices). Initiatives such as Catchment Sensitive Farming are already in place to tackle diffuse pollution. These actions should be strengthened by the introduction of Water Protection Zones (WPZ), aimed at encouraging the use of sustainable urban drainage, whilst associated increased regulatory powers should help to address misconnected sewerage and industrial effluents. Over the longer term such measures should help to reduce maintenance needs and ensure that river restoration activities move towards more sustainable options. However, it is essential that both river restoration and wider catchment initiatives that impact on river projects are well understood (Hicks and Malmqvist, 2007), especially in the context of ground water and surface water exchanges both in the context of flood risk and farming practices. Currently there are few evidence-based results and so it is essential that policy works towards ensuring that both necessary river management and comprehensive monitoring schedules are mandatory within a project.

10.13 Project appraisal and research needs

While Before-After Control-Impact (BACI) designs can provide powerful statistical results, the lack of funding for pre- and post-project monitoring has resulted in few BACI monitoring studies in the published scientific literature. Ecological variability is always an issue when determining 'control' sites in field-based research, which further limits the number of projects that can be used to assess project success to the appropriate level statistical significance (Underwood, 1994). However it should be noted that other valid assessment methods exist, such as before-after studies that are extensive (evaluations of many sites) or intensive (in-depth evaluation of a few sites) as well as extensive and intensive post-project only evaluations. There are advantages and disadvantages to all of these (Table 10.2) and clear objectives are still key to successful assessment. As interest in GW/SW interactions is relatively new, the problem is further compounded when trying to determine the success rate and reasons for the success or failure of projects in restoring or altering the subsurface flow characteristics, as well as the impact of such alterations on pollution and ecology. River restoration projects provide the potential to carry out experiments for ecological and hydrological questions (Palmer et al., 2005). This is a great opportunity, particularly to improve understanding of the physical-ecological relationships of the hyporheic zone. Thus the lack of concrete objectives for restoration projects not only hampers their ability to be evaluated, but also results in the loss of a great research opportunity. Incorporating research objectives and approaching restoration projects as experiments may not only help the scientific understanding of these systems but also assist in the development and propagation of suitable study design to allow scientifically sound evaluation of restoration success and processes of response (Wohl et al., 2005).

Table 10.3 Summary of advantages and disadvantages of the five major approaches for evaluating restoration projects (from Roni et al., 2003, modified from Hicks et al., 1991).

<u>Attribute (pros and cons)</u>	<u>Before and after</u>			<u>post treatment</u>	
	<u>Intensive</u>	<u>Extensive</u>	<u>BACI</u>	<u>Intensive</u>	<u>Extensive</u>
Ability to assess interannual variation	Yes	yes	yes	yes	no
Ability to detect short-term response	Yes	yes	yes	no	yes
Ability to detect long-term response	Yes	no	yes	yes	yes
Appropriate scale (WA=watershed, R=reach)	R/WA	R/WA	R/WA	R	R/WA
Ability to assess interaction of physical setting and treatment effects	Low	high	low	low	high
Applicability of results	limited	broad	limited	limited	broad
Potential bias due to number of sites	Yes	no	yes	yes	no
Results influenced by climate, etc.	Yes	yes	yes	yes	no
Length of time needed to detect response (years)	10+	1-3	10+	5+	1-3

While the lack of monitoring objectives may limit the ability to assess project success, the lack of suitable study design is also a major impediment for scientifically sound evaluation of restoration success and processes of response. The Before-After: Control-Impact (BACI) approach to assessing effectiveness of manipulations is generally thought to be the best approach for project assessment. Whilst some studies have provided information about how best to implement this type of approach (e.g. Roni, 2005), there is currently not a standardised methodology for UK systems. While, in the UK, the Environment Agency has fairly comprehensive monitoring networks with respect to water quality, fisheries, and invertebrates, sampling protocols have not been developed specifically for answering river restoration questions.

Monitoring (or project appraisal) becomes even more complex, since ecology and morphology are highly variable, limiting the feasibility of BACI designed assessments when 'control' sites are difficult to find. To date, the number of projects that have been appraised to evaluate project success with statistical confidence remains very low (Palmer et al., 2005). This is partly a result of lack of guidance, but is exacerbated by uncertainty in funding monitoring of streams both prior to project development and beyond a period of 3 years (the point where both physical and biological changes to a new equilibrium state are likely to be achieved) (Roni, 2005). While adding GW/SW interactions and demonstrating how these interface with river restoration objectives and techniques adds another layer to the monitoring question, it is also possible that adding this information to the project appraisal could result in a more complete understanding of the mechanisms of project success or failure. Above all, it is clear that development of a clear monitoring protocol appropriate to the questions that need to be answered is therefore essential for effective restoration project assessment.

10.14 Conclusion

There are many challenges relating to river restoration. At its simplest it requires a clear rationale of why the restoration work is being carried out, choice of the most appropriate technique, an appreciation that it may be necessary to carry out supplementary work in the terms of adaptive management and a recognition of the impacts of the work laterally, longitudinally, and vertically in terms of physical, biological and hydrological processes. There will be less confidence in these aspects with larger scale projects, with increasing complexity of techniques and where multiple objectives are required. However it is important to take the larger river basin processes into account when designing river restoration projects. Researchers and practitioners alike are becoming more aware of the importance of whole-system integration, both at a disciplinary level and geographical scale, when it comes to determining and implementing ecologically successful river restoration projects (Hannah et al., 2007).

Assessing where intervention is most appropriate and what should be done can be hampered by lack of knowledge of catchment-wide impacts and processes (Harrison et al., 2004), as well as more local interactions within and between the longitudinal, lateral and vertical dimensions. Understanding the relevance of GW/SW interactions within the river system is usually a forgotten process within river restoration projects. With the advent of the WFD, and the hope of implementing more integrated catchment-wide management issues that go beyond in-channel river restoration, there is now a greater need to understand such water interactions not only in the context of water chemistry and biology but also river and floodplain natural processes and ecosystem services. This includes aspects such as flood risk, water resource issues, and natural pollutant attenuation. GW/SW interactions operate at a range of scales and therefore can be affected by any in-channel or floodplain modification. The impact of river manipulation on these processes should be recognised as part of a river restoration strategy and in turn appreciating how these interchanges are disrupted could help practitioners to determine the wider success of a project and also predict future river management and maintenance needs.

11 Recommendations for development of river management strategies and tools

Processes that occur at the groundwater – surface water interface are shown to have sufficient influence on water and contaminant behaviour, and on river ecosystem integrity and function, to influence the outcome of environmental management decisions for hydrological catchments and river corridors.

It is recommended that the following issues are included in the development of future environmental management strategies, approaches and tools:

1) Include the hyporheic zone in conceptual site and catchment models

Conceptual models of catchments (used to underpin catchment management) and contaminant impacts close to rivers (to inform contaminated site risk management) should include an assessment of the effects of processes at the GW/SW interface. Conceptual models should initially **consider the range of ecological goods and services potentially provided by the GW/SW interface**, and prioritise those that are likely to be of sufficient importance to affect environmental management decisions for further investigation.

The catchment context of the river, site or reach must be recognised explicitly when developing conceptual models or considering management options, especially the longitudinal setting of any site (e.g. with respect to downstream change in flow, elevation, channel slope and stream power, Barker et al. (2009). For example, most of the fine sediments (and possibly nutrients and contaminants) transported or deposited in a river system (and likely to affect hyporheic zone operation and habitat suitability) are likely to be sourced from distant catchment hill-slopes, and not the local river banks or bed. Clearly, then, a longer-term sustainable solution to riverine sediment problems may lie in reducing sediment erosion from basin slopes, rather than local 'gravel cleaning'. Sources may be identified using sediment fingerprinting techniques and/or geomorphologic monitoring surveys.

River geomorphology is central to hyporheic zone operation. For example, the recent classification of pollutant attenuation abilities of hyporheic zones carried out for the Environment Agency by Booker et al. (2008) is strongly based on the geomorphologic variables including a simple stream power index (which is known to change non-linearly down-basin; Barker et al., (2009), sediment thickness, sediment permeability and subsurface permeability.

In general, when developing a conceptual model of the GW-SW interface, first establish the geomorphology, then consider the water flow, and finally consider the geochemistry and ecology. Interpretation of hydrochemical or ecological data without placing that data in the context on the wider geomorphologic and flow systems is likely to lead to misinterpretation.

Hyporheic exchange (stream-riverbed-stream) has been found to influence river water quality. Hydrologic models of river networks, such as SIMCAT and others, could be improved by addition of hyporheic exchange and attenuation processes, to better reflect the conceptual understanding of river functioning.

Surface water - groundwater interaction may not always be desirable, especially if the discharging waters are contaminated, at least sporadically, as in many urbanised catchments.

Conceptual models, including information on the GW/SW interface, should be documented as part of good governance in environmental management.

2) Collect the right data: Monitoring and site characterisation

Where GW/SW interface processes are likely to be of sufficient magnitude to influence management decisions, monitoring of those processes should be undertaken to parameterise a conceptual model and to inform a management decision. Data collection should normally start with readily available regional-scale datasets (e.g. superficial and solid geology) and progress to site-specific data collection where the additional data is likely to influence (or significantly improve confidence in) the management decision, and where it is safe to collect the data. Use of existing uninterpreted data, such as river temperature data collected during airborne LIDAR surveys, may provide valuable information on the locations of zones of significant GW/SW exchange, and to inform regional contaminant and water resource management.

Published literature data on GW/SW processes (e.g. natural attenuation rates) are relatively rare, so reliance on conservative literature values is unlikely to be an appropriate strategy in most instances, and some site-specific data collection will be appropriate. The GW/SW interface is often characterised by fine-scale variations in physical, chemical and biological properties, and by spatial heterogeneity, so an appropriate monitoring strategy and design is needed. Long-screen wells are very unlikely to be of value in assessing contaminant fate and transport and assessors should consider methods to **collect data that is representative of the fine-scale heterogeneity** in, for example, redox potential. Spot samples are likely to be of limited value, and continuous measurement with in-situ sampling equipment aligned to data-logging facilities may be necessary. **HZ natural attenuation investigations can apply existing good practice guidelines based on a lines-of-evidence approach** (Environment Agency, 2000), but sampling strategies should be designed to collect evidence of biodegradation, turbulent mixing and dispersion that occurs within a limited spatial zone.

With regard to biological monitoring, river ecological survey methods that rely solely on study of benthic fauna should be used with caution. Collection of hyporheic (interstitial) fauna should be considered in parallel to benthic (kick) surveys in order to benefit from the additional information that hyporheic communities may provide on overall river ecosystem function and integrity. Monitoring of **hyporheic organisms may provide additional benefits as 'biomarkers'** for early identification of detrimental impacts of groundwater pollution plumes on a river. In the case of a groundwater plume migrating into a river, hyporheic organisms are likely to be exposed to higher contaminant concentrations than benthic organisms, due to the significant mixing and natural attenuation processes. Furthermore, microbes can also act as biomarkers, particularly where natural attenuation is the desired method of remediating contaminated systems and where their presence and potential needs to be established.

Assessment of fine sediment issues is crucial at a site and needs to be done thoroughly: complex temporal and spatial variability at all scales has been demonstrated in Chapter 4, and must be characterised to obtain representative estimates of the problem. The proportions of fine sediment fractions (less than 1 mm) should be determined, as this is crucial to habitat quality, especially in salmonid redds. The *quality* of the sediment should be assessed (e.g. pollutant content, sediment-associated contaminants, and organic fraction). The impact of fine sediment on river bed processes should be assessed in terms of the environmental objectives for a given site (e.g. pollutant attenuation versus spawning habitat). Sources should be determined, e.g. with fingerprinting techniques. Investigation methods still require development, but existing techniques are well documented in the cited literature here.

In many situations complex multidisciplinary HZ processes mean that gaps in understanding are best addressed by combining monitoring techniques. This variety of methods and devices has implications that also create specific challenges, including:

- **Method combinations:** among the wide possibility of method combinations, some are better suited for specific studies or environments; some are highly complementary or especially useful to multidisciplinary studies. For management purposes, a proper evaluation of these methodological combinations still has to be done.
- **Uncertainty characterisation:** every technique has its own type and level of uncertainty; a current challenge is to assess these measurement errors as well as any modelling assumptions, and make this information available.
- **Robust devices:** different tools have been developed in different environments, e.g. lakes, rivers or estuaries. In dynamic and potentially rough conditions such as streams, work is still needed to improve the resistance of some devices against physical constraints. Additionally not all techniques are commercially available, thus purchasing a fit-for-purpose device often remains a challenge;
- **Standard procedures:** the development of guidelines and standard monitoring approaches would be beneficial in management terms. Although each river is unique, many problems require similar monitoring approaches, which, once understood, may help produce helpful guidelines.

3) Evaluate all of the important processes: Risk assessment

Managing the hyporheic zone requires assessors to think holistically and consider the wide range of different aspects and disciplines. Management tools and decisions should take into account, for example, research on the ecological response to chemical and physical pressures in the GW/SW interface, to better estimate the response of receptors (i.e., the ecology) to anthropogenic pressures. Assessments that attempt to deal with a single HZ process or management objective in isolation or ignorance of other processes are liable to fail or cause unforeseen detriment. **Think holistically and recognise that modifying the HZ system to achieve one management objective may have other consequences.**

Existing hydrogeological risk assessment frameworks are sufficiently flexible to allow the HZ to be incorporated into existing technical assessment processes (e.g. for contaminated soil and groundwater, and for water resource permitting). However, additional reference in current guidance to the role of the HZ and to the available research and guidance already published by the Environment Agency and others

would help to ensure more frequent consideration of the HZ in this context. It is recommended that the tiered approach commonly used in regulatory risk assessment methods (Environment Agency, 2006) be modified to include the opportunity to consider processes at the GW/SW interface in the later tiers. Ecological risk assessment methods need to be further developed to incorporate HZ fauna and functions.

4) Modelling, prediction and forecasting

Existing groundwater models are suitable for regional water resources planning, but are generally unable to simulate local scale flow, contaminant transport, or ecological processes in the GW/SW interface. Improved models should be developed where conceptual understanding indicates these aspects are likely to be material to a management decision. Initially simple analytical models may be applied to test parameter sensitivity and to 'get a feel' for how a system responds to being stressed. Numerous runs with an analytical model, or use of probabilistic methods (e.g., Monte Carlo analysis) can provide this information, however, more complex multi-process numerical models are likely to be needed to simulate the whole HZ system accurately. Selection of modelling tools should be made having regard to the management decision that needs to be made, and the manpower and data implications to generate a robust model. Where HZ processes are likely to be critical to a management decision, a model that simulates the HZ robustly, rather than as a simple boundary condition (as in existing groundwater models) should be used.

In order to improve existing regional groundwater models, the lessons learned from examples of good practices (e.g. Condoover model; BGS & Environment Agency, 2008) should be used to test and validate conceptual understanding and results incorporated into older groundwater models.

5) River / catchment management

River and catchment management strategies and plans should be developed having regard to the full range of ecosystem goods and services that occur in a catchment. Consideration of processes in a full range of disciplines (i.e. outside of technical or legislative silos) and issues will help ensure the best overall decisions.

River – groundwater connectivity is shown to be key for a range of water resource, ecological, flood risk-management and contaminant attenuation issues. **Hydrologic connectivity should be re-established where feasible**, and where it would not cause discharge of contaminants from one water body to another.

6) Restoration and remediation

River restoration should take account of hyporheic and riparian zone processes and functions and seek to enhance those processes to help ensure a fully functioning river corridor. Vertical and horizontal connectivity should be re-established where they originally occurred.

Clear project objectives should be established prior to the design and implementation of river restoration, which seeks to optimise the overall ecologic and hydrologic benefits. Success criteria should be documented early in the process, which will normally include restoration of hyporheic zone functions as part of a holistic approach to river corridor improvement.

Post-project appraisal is essential after any intervention project. Before-and-after monitoring should be resourced and designed objectively to evaluate the observed effects against the desired objectives. Publishing results is encouraged and will allow a library of peer-reviewed project outcomes to be evaluated to help the future development of successful approaches.

12 Recommendations for research

12.1 Introduction

Recently, there has been much interest in researching groundwater - surface water interactions and, in particular the hyporheic zone, as demonstrated by a growing number of conference sessions and special issues of journals, as well as the establishment of HNet, the Hyporheic Network (<http://www.hyporheic.net>). Research interest in this area is not completely new, but in the past it has often been restricted to single discipline issues, which has led to different conceptual models being developed by different disciplines (Figure 1.2). Furthermore, the terms of reference and scale of investigation differs markedly between disciplines. In Chapter 2, we identified the many policy and operational aspects of environmental management that may be affected by, or will affect, groundwater - surface water interactions. In Chapters 3-10, we identified the current level of knowledge. Comparing the management needs with current understanding, it is clear that there is both need and scope for further research.

This chapter summarises areas where future research would have scientific and practical relevance. The knowledge gaps and potential research projects can be grouped into three broad areas:

- Considering the significance of groundwater - surface water interactions in the wider context of catchment management;
- Deepening our understanding of the processes involved in groundwater - surface water interactions;
- Developing better tools for monitoring and modelling of groundwater - surface water interactions.

These areas are considered below. We do not provide a comprehensive review of the possible research questions; rather we have provided some overview comments and some examples of the type of research topic which could usefully be explored. This chapter should be read in conjunction with Chapters 3-10, where the background state of knowledge and appropriate references have been presented.

12.2 Significance of groundwater - surface water

12.2.1 Interactions in catchment management

The whole of Europe, and much of the rest of the world, is moving towards integrated catchment management. This recognises that water is connected across catchments, just as land is, and that ecosystems and society are similarly connected across spatial and temporal scales. As a result, research is needed to consider:

- whether groundwater - surface water interactions are significant at the catchment scale and so should be considered as catchment management plans are being developed;

- in contrast, whether catchment-scale processes affect groundwater - surface water interactions so that catchments should be managed sensitively to avoid adverse effects.

12.2.2 Catchment scale influences of groundwater - surface water interactions

Hyporheic exchange flows. Many researchers have recognised that the exchange of flow between surface water, hyporheic and riparian sediments, and deeper groundwater has the potential to change water chemistry and, in particular, to attenuate pollutants such as nutrients or organic contaminants. The cumulative effect of these changes as water moves downstream will often be significant at catchment scale and there may be consequential effects on the ecology of the river and sediments. The complex geochemical and microbiological processes involved require better quantification so they can be incorporated in management models to give more certainty in predictions of attenuation and ecological impacts.

Plants, sedimentation and attenuation. There are complex interactions between the growth of aquatic plants and local sedimentation, and both are linked to the presence and potential attenuation of nutrients and other pollutants. This web of interactions is not well described or quantified. Are the cumulative effects significant at the catchment scale?

Refuge in the hyporheic zone. The hyporheic zone can provide refuge for organisms during extreme events such as floods, droughts and pollution incidents. How important are such refuges for the recovery of ecosystems after extreme events? Are there management actions that should be taken to ensure refuges are available and effective? Given the importance of the HZ to stream ecosystem and biogeochemical functioning and integrity, the need to maintain and protect vertical linkages within riverine systems is widely accepted but still requires further interdisciplinary research.

12.2.3 Significance of catchment processes for groundwater - surface water interactions

Catchment sediment management. In the long-term, the sediment and geochemical characteristics of hyporheic zones are derived from catchment scale processes of sediment supply. How do land-use policies and catchment practices affect these supplies in the heavily utilised and managed catchments of the UK and Europe? How long does it take for catchment management changes to alter groundwater - surface water interactions, and are the effects significant?

Urban hyporheic zones. Hyporheic zones in urban rivers have a number of key differences from those in rural areas. For example they often have more weirs which will affect sediment distribution, they will receive more fine sediment from roads and other urban sources, and point sources of pollution are frequently located on urban floodplains. How do these urban catchment processes affect groundwater - surface water interactions locally, and do they have significant impacts at the catchment scale? Do urban rivers require different management approaches in order to protect urban hyporheic zones and to minimise adverse effects on groundwater - surface water interactions in their downstream catchments?

Human impact on hydrology. Hydrological changes are common in catchments because of reservoirs, groundwater and surface water abstractions, and effluent

discharges. These flow changes reduce the variability of lower flows and change flow duration curves, especially for lower flows which may be increased or reduced. There has been little research on the effects of such hydrological alterations on the hyporheic zone's geochemistry and ecology despite the potentially large impacts. Data on natural reference conditions, for comparison with 'impaired' environments, is very sparse but is needed to inform management decisions, including those related to restoration.

Climate change and variability. The latest forecasts for climate change imply major changes to hydrological regimes over most of the UK, with lower groundwater recharge and summer flows in southeast England. How will these changes affect groundwater - surface water interactions and hyporheic zones (e.g. ecology and pollution attenuation)? What will be the impact of more extreme hydrological events?

12.3 Process understanding of groundwater - surface water interactions

Geomorphology and hyporheic zone characteristics. New datasets based on GIS and digital elevation models are leading to new, more detailed models of the links between catchment scale geomorphology and hyporheic zone characteristics. These have yet to be tested fully, and their implications for habitats are still to be explored.

Bed siltation dynamics. The national extent of river bed siltation in the UK is uncertain, as are the controls and dynamics during individual storm events. Little monitoring and field, laboratory and numerical experimentation has been carried out here, and few data are available to be able to predict the impacts on exchange flows, groundwater discharge, and habitats.

Hyporheic and benthic ecosystems. What are the functional relationships between hyporheic and benthic ecosystems? How dependent is stream ecosystem functioning on the status of the hyporheic ecosystem and how sensitive is it to changes in groundwater discharge and quality or to changes in bed sedimentation?

Bioturbation. The collective effect of the activities of organisms on their environment has been termed 'ecosystem engineering'. Although experimental research exists, *in situ* field observations of organisms' impacts on HZ properties have been limited to date. To what extent does invertebrate burrowing and bioturbation affect sediment permeability, water and nutrient fluxes, and chemical (e.g., oxygen) concentration distributions in the hyporheic zone? What are the recovery times for permeability, fluxes and concentration profiles after extreme events such as floods, droughts, pollution incidents or sedimentation changes?

Hot spots. It is possible that there are hot spots (i.e. places) and hot moments (i.e. times) for activity related to groundwater - surface water interactions, whether these are related to flow, chemistry or ecology. Research could provide a theoretical basis for such hot spots, which in turn could lead to methods to identify or predict them. Such hot spots would then be areas to protect and manage, as well as target sites for detailed research on processes.

Microbial and invertebrate community. The structure and functioning of the microbial and invertebrate communities of the HZ have received little attention until recently,

despite their importance for assessing the potential for pollutant attenuation and a holistic assessment of stream ecosystem function and change. Much research is needed, for example to characterise biofilm structure, understand regulation mechanisms exerted on microbiota by interstitial predators and grazers, and to examine the role of fungi.

Microbial respiration. Techniques are needed to measure actual rates of microbial processes, preferably doing the measurements under in situ conditions. These can then be used to measure and scale up rates of biogeochemical cycling to provide more robust estimates of geochemical changes and pollutant attenuation capacity.

Pathogens. Given that microbial pathogens can be discharged to rivers in sewage effluents and to groundwater from leaking sewers and septic tanks, how significant is the hyporheic zone in the transport, persistence and pathogenicity of microbial pathogens (including viruses)?

Groundwater and salmonids. The influence of groundwater on salmonid spawning gravels has been shown to vary spatially and temporally. However its extent and influence on developing salmonid embryos is not easy to predict or evaluate, and there is a role for direct high resolution and well targeted measurements to improve our understanding of groundwater influences on developing salmonid embryos.

Morphological changes. Morphological changes to rivers and their riparian zones are made at various scales, e.g. for flood defence, managed retreat, and habitat creation. The impacts of such changes on groundwater - surface water interactions and hyporheic zones are rarely assessed but they may be major if water velocities, water levels, bed materials and sedimentation are altered. There is a need for more observational research to be carried out on such projects to understand and quantify how significant such morphological changes are and whether their design should take more account of groundwater - surface water interactions.

Connectivity: HZ as a migration corridor. There is a need for further research to investigate when and how the hyporheic zone functions as a migration corridor for ecological change and restoration. To inform regulators and decision maker on this topic of great practical relevance, methodologies are required to scale-up from (sub)reach-scale research to the larger scales often more relevant to river management.

12.4 Monitoring and modelling tools

Lack of baseline data. Field studies suffer often from a lack of baseline data on ecology and chemistry, to describe, quantify and assess the structure and function of hyporheic zones over a range of scales. Future research will need to address these shortages by proposing new, alternative and possibly more efficient and robust methods and technologies for generating baseline hydrological, chemical and biological time-series. A key requirement for the generation of new baseline data is to ensure a detailed coverage of relevant scales as well as easy availability and access to archived information.

Rapid and high resolution field tools. There is still a need for rapid and routine techniques that can provide a wide range of spatially distributed measurements at high

resolutions. For example, ways to measure solute concentrations, hydraulic properties, sediment characteristics, and ecological variables rapidly and locally will support all the research objectives discussed about, and allow us to understand the significance of heterogeneity of properties and of processes.

Temporal variability. Just as there is a need for better spatial measurements, there is a need to be able to rapidly and routinely measure temporal variations caused by seasonal and event-based changes. For example, being able to capture the temporal variability of geometry and hydraulic properties, and embed these changes in models, would enable dynamic modelling of flow and solute transport and greatly improve our ability to test hypotheses and quantify processes.

Microbiological sampling. Understanding of the role of interstitial and attached micro-organisms in geochemical processing and ecological food webs will require development of sampling methods. There are opportunities to use various new molecular techniques from other environmental areas to understand community structure, and to observe the response of microbiological communities to environmental stimuli.

Dynamic models. Long-term and event-based changes take place in zones of groundwater - surface water interaction. These include sedimentation changing the geometry, significant temperature changes, bioturbation effects on permeability, growth of macrophytes which in turn alter water depths and velocities, and so on. Present day numerical models are not able to incorporate such dynamic effects across the wide range of variables, and so hinder our ability to interpret field observations of processes. There are research opportunities to create a new generation of models which have more ability to handle temporal changes in boundaries and properties.

12.5 Conclusions

Integrated approach. None of the research challenges above can be solved by a single discipline. The recommended research questions are motivated by the knowledge demands of regulators and decision makers – generally calling for integrated and interdisciplinary solutions. To provide such solutions, it is necessary to further integrate and exchange the knowledge provided by the different scientific disciplines investigating HZ process dynamics. Interdisciplinary research programs will require new ideas of how to integrate knowledge from different disciplines, which could include the generation of proxies and transfer functions for scaling or creating ‘new’ information in related disciplines.

The application of molecular techniques for the analysis of microbial communities will provide a raft of information covering HZ and river health and human health impacts as it would excise information regarding fate of pollutants and of microbial pathogens whilst supporting more chemical and physical disciplines that focus on biogeochemistry, temporal variability and ecosystem services .

Glossary

<i>Advection:</i>	The process of the movement of solute due simply to the movement of the water containing it.
<i>Analytical Model:</i>	Exact mathematical solutions of the flow and/or transport equation for all points in time and space. In order to produce these exact solutions, the flow/transport equations have to be considerably simplified (e.g. very limited, if any, representation of the spatial and temporal variation of the real system).
<i>Auger:</i>	A device often used for installing wells or extracting soil samples. Hand augers allow for drilling and installation of shallow wells in soft sediments whereas powered augers can be used in harder substrates. Examination of the sediment while drilling allows for description of the substrate characteristics.
<i>Automatic Sampler:</i>	A device used for sampling water at regular time intervals or at different river stage without the presence of an observer.
<i>Bedform:</i>	Any sedimentary-process formed structure present in the bed of a river. Usually ripples, dunes, plane beds, riffles, steps, and pools.
<i>Breakthrough curve:</i>	Usually a plot of concentration against time or number of pore volumes at a given observation point. Usually in the context of solute arrival at a receptor (e.g. river).
<i>Bioturbation:</i>	The disturbing of sediments by movement of organisms.
<i>Casing:</i>	A pipe (usually steel or PVC) preventing loose rocks, unstable sediments or other material from collapsing from the walls into the well shaft. Adding a grout seal along the external wall of the casing prevents water or contaminants from infiltrating along the well.
<i>Catchment:</i>	The area from which a river or stream, or segment of either, collects water. The surface water catchment and groundwater catchment of a river need not be coterminous. Watershed in the terminology of USA publications usually refers to the surface water catchment of a river/stream.
<i>Colmatage:</i>	Clogging material formed by the process of colmation.
<i>Colmation:</i>	Colmation is the clogging of river bed sediments by fine material sedimented out of the water column or filtered out by passage of inflowing river water.
<i>Conceptual Model:</i>	A simplified representation or working description of how the real hydrogeological system is believed to behave. A quantitative conceptual model includes preliminary calculations, for example, of vertical and horizontal flows and of water balances.
<i>Darcian flow:</i>	Flow that can be described using Darcy's Law (see <i>Permeability</i>). Darcy's Law is valid for laminar flow but becomes increasingly inaccurate as the transition to turbulent flow is approached (see <i>Reynold's Number</i>).
<i>Darcy's Law:</i>	An equation that describes the flow of a fluid through a porous medium. Notably it states that discharge is proportional to the medium's permeability and to the magnitude of pressure drop between two points.
<i>Diffusion:</i>	The movement of solute mass from zones of high

- concentration to those of low concentration brought about by thermal agitation and collision of the solute molecules. It is a very slow process. Take the case of a saturated block of rock, with one face held at a constant concentration: it would take over 1000 years for concentrations at 2m from this face to rise to 50% of the concentration at the face. Diffusion occurs at the same rate irrespective of water velocity.
- Dispersion:* The mixing of solute during transport in water (surface water or groundwater). Thus an initially sharp, undispersed concentration front will become 'smeared' into a transition zone where concentrations gradually change from the background concentration to the concentration of the invading solution. Dispersion will continue to increase as travel distance increases. Dispersion is caused by the water taking different routes through a system, each route being associated with a different velocity. As flow velocities become slower, diffusion becomes an increasingly important dispersive process. Diffusion can also be an important dispersive process in fractured low permeability but porous rocks (e.g. UK chalk, UK Jurassic Limestones, tills): in this case, the large surface area of the fractures allows significant diffusive mass transfer into the matrix blocks, thus reducing the relatively small mass present in the fracture.
- Distributed Model:* Model where the heterogeneity of the real system is represented by spatial variation in the inputs and outputs. Compare lumped model.
- Downwelling:* Downflow, usually in the context of flow from river to river-bed sediments. Often refers to river/sediment exchange rather than recharge of deep groundwater, though distinguishing between these flow types may not be possible in all cases.
- Drawdown:* The change in water level relative to some initial level. Often used in the context of pumping boreholes: here in a homogeneous system the water level will fall such that the surface it forms is shaped like the bell of a trumpet, with the borehole in the centre ('the cone of depression'). The drawdown at any radius from the borehole is then the initial water level elevation minus the present water level elevation.
- Drilling Rig:* A machine available in a large range of sizes, creating boreholes into the ground, notably for water wells, and allowing for the sampling of the substrate. Drilling techniques include rotation, percussion or vibration.
- Dye:* A colored substance added to a water body. In studies of GW/SW interactions, it is used to assess connectivity between streams and adjacent aquifers, flow velocity, as well as retention of stream water into the subsurface.
- Effluent:* Flow out of the ground into a river.
- Electrical Resistivity Imaging:* A geophysical method for imaging subsurface structures based on the injection of electric currents into the ground or in a borehole, and the measurement of resulting differences in electric potential at the surface. The electrical properties of the subsurface may be related to the lithology, to the water content or to the hydrochemistry, as well as to the presence of buried structures.
- Empirical Model:* A model which is based on establishing empirical

	relationships between sets of variables from observed data, without defining the underlying physical principles. Compare physics based model.
<i>Fickian:</i>	Refers to an assumption of the standard approach for describing dispersion – essentially that solute mixing due to different groundwater velocities can be quantified as <i>dispersive flux = - cross sectional area x dispersion coefficient x concentration gradient</i> .
<i>Finite Difference:</i>	A numerical approximation method used to convert mathematical equations in a physics based model into algebraic equations that can be solved numerically on a computer.
<i>Flow Gauging:</i>	The process of determining the discharge in a channel. Methods include injecting a tracer in the water and recording its passage downstream (dilution gauging), measuring the water velocity across a channel section (velocity gauging) or measuring the height of the water surface where its relationship with flow is known (through a rating curve).
<i>Fraction of Organic Carbon (foc):</i>	The total mass of organic carbon divided by a unit mass of sediments. In contaminant studies, this parameter is related to the capacity of the sediments to retain solutes of interest.
<i>Gel Probes:</i>	Passive samplers fitted with a plastic assembly allowing for the deployment of the probe in the sediments. They are used to obtain hydrochemical depth profiles at submillimetre resolution. The DET technique (Diffusive Equilibrium in Thin Films) relies on the diffusion of solutes from the pore-water to a hydrogel until equilibrium with the pore-water is reached. In the DGT technique (Diffusive Gradients in Thin Films), an additional layer of diffusive gel and resin gel separates species kinetically; different thicknesses of diffusive gels are used to test the capacity of the sediments to resupply solutes.
<i>Grab Sampling:</i>	The action of sampling in a short-time at a defined location. It differs from a composite sampling, where samples are temporally or spatially distributed in order to capture variability at the studied site.
<i>Grid:</i>	Network of points in space (nodes) for which a numerical model requires inputs and produces outputs.
<i>Ground Penetrating Radar (GPR):</i>	A geophysical method for subsurface exploration that uses radio waves to detect interfaces between different lithologies. It can be deployed in a non-invasive way by hand or vehicle (or from aircrafts and satellites at a large scale) or in boreholes.
<i>Groundwater-river interface:</i>	Fluvial sediments through which there is exchange of water (over any time period) between a stream and geologic media.
<i>Head:</i>	The elevation to which water would rise in a pipe inserted into the ground and whose end is located at the point of measurement. It is a measure of the energy available to the water: groundwater flow will occur from locations of higher head towards locations of lower head, in isotropic permeability systems directly down the steepest hydraulic head gradient. If there is a vertical flow component, heads will increase with depth – the deeper the end of the pipe, the higher the water level in it if flow is upwards. Head can be measured relative to any convenient datum, though once the

	datum is fixed it must be used for all heads when calculating flow magnitudes (see ' <i>Permeability</i> ') and directions.
<i>Hydraulic conductivity (K):</i>	A property that describes the facility with which water flows through pore spaces and fractures. Values range over several orders of magnitude and depend on the degree of saturation as well as the properties of the medium (intrinsic permeability) and those of the fluid (density, viscosity). See ' <i>Permeability</i> '.
<i>Hydraulic Gradient:</i>	The rate of change of pressure head between two points, expressed in head drop per unit length. Water normally flows in the direction of the maximum hydraulic gradient.
<i>Hydraulic (or Piezometric) Head:</i>	A measure of water pressure expressed in units of length, relative to an arbitrary reference point. A groundwater head is usually derived from a measurement of water surface elevation in a piezometer.
<i>Hyporheic Zone:</i>	That part of the groundwater-river interface which is water-saturated and in which there is exchange of water from the stream into the riverbed sediments and then returning to the stream, within timescales of days to months.
<i>Hyporheos:</i>	A community of organisms inhabiting the hyporheic zone.
<i>Influent:</i>	Flow into the ground from a river.
<i>Integrated Model:</i>	A numerical model in which surface and subsurface flow equations are coupled and solved simultaneously.
<i>Kick-net:</i>	A net used for the sampling of aquatic invertebrates, often made of a sack shaped net attached to a frame at the end of a pole. A kicking of the riverbed allows for the dislodging of benthic invertebrates, which are capture downstream into the net.
<i>Lumped Model:</i>	Model where the each input parameter is represented by only one value over the whole model area, e.g. a lumped water balance model for a catchment will use one value for recharge, one value for baseflow to rivers one value for abstraction etc. over the whole catchment.
<i>Mathematical Model:</i>	Mathematical expression(s) or governing equations which approximate the observed relationships between the input parameters (recharge, abstractions, transmissivity etc.) and the outputs (groundwater head, river flows, etc.). These governing equations may be solved using analytical or numerical techniques.
<i>Meiofauna:</i>	Small invertebrates < 1mm in size, including microcrustaceans, tardigrades, rotifers, small oligochaetes and nematodes.
<i>MODFLOW:</i>	A numerical groundwater model code developed by the United States Geological Survey (McDonald and Harbaugh, 1988).
<i>Natural Attenuation:</i>	The effect of naturally occurring physical, biological and chemical process to reduce the concentration, flux or toxicity of contaminants in the environment without human intervention.
<i>Numerical Model:</i>	Solution of the flow and/or transport equation using numerical approximations, i.e. inputs are specified at certain points in time and space which allows for a more realistic variation of parameters than in analytical models. However, outputs are also produced only at these same specified points in time and space.

<i>Packer:</i>	Inflating seals allowing for the sealing off of a segment of borehole to perform aquifer tests or depth-specific water sampling.
<i>Permeability:</i>	The constant of proportionality in Darcy's Law in the form $Q = -AKi$, where: Q is discharge [L^3T^{-1}]; A is area, measured perpendicular to flow, through which flow occurs [L^2]; K is permeability [LT^{-1}]; and i is head gradient [-]. Also termed hydraulic conductivity. K is a function of fluid density and viscosity, and hence is temperature-dependent ($K = k / \rho \nu$ where k is intrinsic permeability [L^2], ρ is unit weight of fluid (density x acceleration due to gravity) [$ML^{-2}T^{-2}$], and ν is viscosity [$MT^{-1}L^{-1}$]).
<i>Physics Based Model:</i>	A numerical model which is based on mathematical representations of physical hydrological processes.
<i>Porosity:</i>	A fraction between 0 and 1 that represents the proportion of void spaces, relative to a given volume of material. The measure is independent of the filling (e.g. water, air). Porosity typically ranges from 0.01 for fractured rocks to 0.5 for clay.
<i>Pumping:</i>	In the context of hyporheic zone flow, this is the process whereby sediment surface head boundary conditions induce river water to enter and subsequently exit the sediments. Usually applied to the bedform (e.g. dune) scale rather than larger (e.g. riffle-pool sequence) scale. Context should indicate exactly which processes are included within the term.
<i>Radius of influence:</i>	The radius at which the drawdown around a pumping well is zero or effectively zero.
<i>Regional Model:</i>	In the context of this report, a regional model is synonymous with a regional distributed time-variant groundwater model.
<i>Reynold's Number:</i>	A dimensionless number indicating the importance of turbulent flow relative to laminar flow. Defined in general by $R_e = \rho v D / \mu$ where: ρ is fluid density [ML^{-3}]; v is fluid velocity [LT^{-1}]; D is a characteristic length of the system [L]; and μ is viscosity [$ML^{-1}T^{-1}$]. Representative lengths are defined in different ways by different authors, but taking L to be hydraulic radius ($R = \text{flow cross sectional area} / \text{wetted perimeter}$) for open channel flow, flow is likely to be turbulent for $R_e > 2000$. Taking L to be average grain diameter for porous media flow, Darcy's Law becomes invalid in the range 1 – 10.
<i>SHE:</i>	Système Hydrologique Européen. A numerical model code representing the entire land phase of the hydrological cycle (integrated catchment model) developed by the Danish Hydraulic Institute, Sogreah of France and the Institute of Hydrology.
<i>Spatial Distribution:</i>	Representation of variables (e.g. model parameters or outputs) that change with spatial position.
<i>Steady-state flow:</i>	Flow that is time invariant, i.e. surface water levels/ (groundwater) heads remain constant in time. Where flows change in time, the system is said to be 'unsteady-state' or 'transient'.
<i>Storage coefficient:</i>	A hydraulic property of a porous medium. The volume of water yielded from an aquifer per unit horizontal area per unit change in water level.
<i>Stygobites:</i>	Organisms that may display some adaption for subterranean

	life and they are obligatory inhabitants of hypogean habitats, including the hyporheic zone, as well as deeper groundwater dominated habitats such as aquifers and caves.
<i>Stygophiles</i>	Organisms that have a greater affinity to the hyporheic environment and actively exploit resources and the available habitat.
<i>Stygoxenes:</i>	Organisms that have no affinity with groundwater habitats but occur there accidentally due to passive infiltration.
<i>Tailed breakthrough:</i>	Solute concentration breakthrough where there is a long concentration/time tail, i.e. concentrations may take a long time to rise to the maximum concentration, or a long time to fall back to a minimum concentration.
<i>Thermal Infrared Imagery (TIR):</i>	A technique using an infrared scanner and a detector creating an image of the thermal environment. In GW/SW studies, airborne TIR allows for the detection of groundwater discharge in streams where differences of stream and groundwater temperatures are significant.
<i>Time-variant Model:</i>	Model where the inputs and outputs vary in time (also known as transient or unsteady model).
<i>Transient flow:</i>	Time-variant flow. See <i>Steady-state flow</i> .
<i>Transient Storage Model:</i>	A model which represents rates of exchange of solutes between groundwater and river water, and short term solute storage in the hyporheic zone. There are many different types of transient storage model, based on empirical or physics based approaches, and using analytical or numerical methods.
<i>Transmissivity:</i>	A hydraulic property of a porous medium. The integral of permeability over depth: for a homogeneous system, the product of the permeability and the saturated thickness. [L^2T^{-1}]
<i>Turnover:</i>	In the context of hyporheic zone flow, this is the movement of water due to (water-containing) sediment erosion and deposition.
<i>Unstable unsaturated flow:</i>	In the unsaturated zone above a water table sometimes the more usual approximately uniform advance of a wetting front breaks up into 'fingers' of nearly saturated flow separated by zones of much lower moisture content where little flow occurs. Such situations can be initiated by the presence of a finer-grained layer overlying a coarser-grained layer. Capillary forces enable finer-grained sediments suck up and retain water much more readily than coarser-grained sediments. In this circumstance, recharge from above will allow the finer-grained upper layer to saturate without water entering the lower coarser-grained layer. Once the heads in the upper layer have built up sufficiently, flow is initiated at local heterogeneities in the lower layer: as the saturated permeability of this layer is greater than that of the upper layer, flow is limited to narrow fingers centred on these local heterogeneities, much like the localized dripping of water out of the base of a saturated sponge.
<i>Upwelling:</i>	Upflow, usually in the context of river-bed sediment to river discharge. Often refers to river/sediment exchange rather than discharge of deep groundwater, though distinguishing between these flow types may not be possible in all cases.
<i>Water divide:</i>	Usually means the same as watershed.

Watershed:

The boundary of a catchment. Water on either side of a watershed flows to a different stream or river. May refer to surface water or to groundwater. In US terminology, 'watershed' usually means surface water catchment.

References

Chapter 1 & 2

- Bencala KE. 2000. Hyporheic zone hydrological processes. *Hydrological Processes* **14**: 2797-2798.
- Bencala KE. 2005. Hyporheic exchange flows. In: Anderson MG and McDonnell JJ (Eds), *Encyclopedia of Hydrological Sciences*. John Wiley and Sons, London, Volume 3, Part 10, Chapter 113, pp 1733-1740.
- Boulton AJ. 2000. River ecosystem health down under: assessing ecological condition in riverine groundwater zones in Australia. *Ecosys. Health* **6**: 108-118.
- Boulton AJ. 2007. Hyporheic rehabilitation in rivers: restoring vertical connectivity. *Freshwater Biology* **52**: 632-650.
- Bradley PM, Chapelle FH. 1998. Effects of contaminant concentrations on aerobic microbial mineralisation of DCE and VC in stream-bed sediments. *Environmental Science and Technology* **32(5)**: 553-557.
- Bradley PM, Landmeyer JE, Chapelle FH. 1999. Aerobic mineralization of MTBE and tert-butyl alcohol by stream-bed sediment microorganisms. *Environ Sci Technol.* **33**:1877–1879.
- Bradley PM, Landmeyer JE, Chapelle FH. 2002. TBA biodegradation in surface water sediments under aerobic and anaerobic conditions. *Environ Sci Technol.* **36**:4087–4090.
- Brunke M, Gonser T. 1997. The ecological significance of exchange processes between rivers and groundwater. *Freshwater Biology* **37**: 1-33.
- Conant B Jnr, Cherry JA, Gillham RW. 2004. A PCE groundwater plume discharging into a river: influence of the streambed and near-river zone on contaminant distributions. *Journal of Contaminant Hydrology* **73**: 249-279.
- Council of the European Community (CEC), 1976. Council Directive 76/464/EEC of 4 May 1976 on pollution caused by certain dangerous substances discharged into the aquatic environment of the Community. *Official Journal of the European Communities*, **L 129, 18/05/1976**.
- Council of the European Community (CEC), 1980. Directive 80/68/EEC of the European Council of 17 December 1979 on the protection of groundwater against pollution by certain dangerous substances. *Official Journal of the European Communities*, **L 020, 26.01.1980**.
- Council of the European Community (CEC), 2000. Directive 2000/60/EC of the European Parliament and of the Council of 23 October 2000 establishing a framework for Community action in the field of water policy. *Official Journal of the European Communities*, **L327/1, 23.10.2000**.
- Council of the European Community (CEC), 2006. Directive 2006/118/EC of the European Parliament and of the Council of 12 December 2006 on the protection of groundwater against pollution and deterioration. *Official Journal of the European Communities*, **L372/19, 27.12.2006**.
- Department of the Environment, Transport and the Regions, Environment Agency and Institute for Environment and Health, 2000. *Guidelines for Environmental Assessment and Management*. The Stationery Office, London.

- Department For Environment, Food & Rural Affairs, 2008. Future Water. (available at: <http://www.defra.gov.uk/Environment/water/strategy/>)
- Environment Agency. 2002. The Water Framework Directive: Guiding principles on the technical requirements. Environment Agency, Bristol. ISBN: 1857058674.
- Environment Agency. 2006. Remedial Targets Methodology: Hydrogeological risk assessment for land contamination. Environment Agency publication GEHO0706BLEQ-E-E. Environment Agency, Bristol. (Available at: <http://publications.environment-agency.gov.uk/pdf/GEHO0706BLEQ-e-e.pdf>).
- Fischer H, Kloep F, Wilczek S, Pusch MT. 2005. A river's liver – microbial processes within the hyporheic zone of a large lowland river. *Biogeochemistry* **76**: 349-371.
- Gandy CJ, Smith JWN, Jarvis AP. 2007. Attenuation of mining-derived pollutants in the hyporheic zone: a review. *Science of the Total Environment* **373**: 435-446.
- Hancock PJ, Boulton AJ, Humphreys WF. 2005. Aquifers and hyporheic zones: Towards an ecological understanding of groundwater. *Hydrogeology Journal* **13**: 98-111.
- Jarvie HP, Jürgens MD, Williams RJ, Neal C, Davies JLL, Barrett C, White J. 2005. Role of river bed sediments as sources and sinks of phosphorus across two major eutrophic UK river basins: the Hampshire Avon and Herefordshire Wye. *Journal of Hydrology* **304**: 51-74.
- McClain ME, Boyer EW, Dent CL, Gergel SE, Grimm NB, Groffman PM, Hart SC, Harvey JW, Johnston CA, Mayorga E, McDowell WH, Pinay G. 2003. Biogeochemical hot spots and hot moments at the interface of terrestrial and aquatic ecosystems. *Ecosystems* **6**: 301-312.
- Palmer MA. 1993. Experimentation in the hyporheic zone: challenges and prospectus. *Journal of the North American Benthological Society* **12**: 84-93.
- Smith JWN. 2005. Groundwater – surface water interactions in the hyporheic zone. Environment Agency Science report SC030155/1. Environment Agency, Bristol, UK.
- Smith JWN, Bonell M, Gibert J, McDowell WH, Sudicky EA, Turner JV, Harris RC. 2008. Groundwater – surface water interactions, nutrient fluxes and ecological response in river corridors: Translating science into effective environmental management. *Hydrological Processes*, **22**: 151-157.
- Smith JWN, Lerner DN. 2008. Geomorphologic control on pollutant retardation at the groundwater – surface water interface. *Hydrological Processes*. DOI: 10.1002/hyp.7078
- Smith JWN, SurrIDGE BWJ, Haxton TH, Lerner DN. 2009. Pollutant attenuation at the groundwater – surface water interface: A classification scheme and statistical analysis using national-scale nitrate data. *Journal of Hydrology*. doi:10.1016/j.jhydrol.2009.02.026
- United States Geological Survey (USGS), 1998. Ground water and surface water: A single resource. USGS Circular 1139, USGS, Denver, Colorado.

Chapter 3

- Abernethy, B. & Rutherford, I.D. 1998. Where along a river's length will vegetation most effectively stabilise stream banks? *Geomorphology* **23**: 55-75.

- Acornley R. M., Sear D. A. 1999. Sediment transport and siltation of brown trout (*Salmo trutta* L.) spawning gravels in chalk streams. *Hydrological Processes*. **13**: 447-458.
- Anderson, J.K., Wondzell, S.M., Gooseff, M.N. and Haggerty, R. 2005. Patterns in stream longitudinal profiles and implications for hyporheic exchange flow at the H.J. Andrews Experimental Forest, Oregon, USA. *Hydrological Processes* **19**: 2931-2949.
- Barker, D.M., Lawler, D.M., Knight, D.W., Morris, D.G., Davies, H.N. and Stewart, E.J. 2009. Longitudinal distributions of river flood power: the combined automated flood, elevation and stream power (CAFES) methodology. *Earth Surface Processes and Landforms* **34**: 280-290.
- Baxter, C.V. & Hauer, F.R. 2000. Geomorphology, hyporheic exchange and selection of spawning habitat by bull trout (*Salvelinus confluentus*). *Canadian Journal of Fisheries and Aquatic Sciences* **57**: 1470-1481.
- Bencala, K.E. 2000. Hyporheic zone hydrological processes. *Hydrological Processes* **14**: 2797- 2798.
- Booker, D., Goodwin, T., Griffiths, J., Old, G., Smith, J.W.N. and Young, A. 2008. A classification scheme for pollutant attenuation at the groundwater-surface water interface. Science Report SC030155/SS7, Environment Agency, 122 pp.
- Bowen, D.Q., Phillips, F.M., McCabe, A.M., Knutz, P.C. and Sykes, G.A. 2002. New data for the last glacial maximum in Great Britain and Ireland. *Quaternary Science Reviews* **21**: 89-101.
- Buffington, J.M., Montgomery, D.R. and Greenberg, H.M. 2004. Basin-scale availability of salmonid spawning gravel as influenced by channel type and hydraulic roughness in mountain catchments. *Canadian Journal of Fisheries and Aquatic Sciences*. **61**: 2085-2096.
- Cardenas, M.B. 2008. Surface water-groundwater interface geomorphology leads to scaling of residence times. *Geophysical Research Letters* **35** L08402.
- Cardenas, M.B. 2009. A model for lateral hyporheic flow based on valley slope and channel sinuosity. *Water Resources Research* **45** W01501.
- Cardenas, M.B. & Wilson, J.L. 2007. Hydrodynamics of coupled flow above and below a sediment-water interface with triangular bedforms. *Advances in Water Resources* **30**: 301-313.
- Carling P.A. 1984. Deposition of fine and coarse sand in an open-work gravel bed. *Canadian Journal of Fisheries and Aquatic Sciences*. **41**: 263-270.
- Carling, P.A., Taylor, P., Hankin, B. and Benson, I. 1999. Fluid exchange and oxygen flux through salmon redds, Environment Agency R&D Report W985.
- Carling, P.A. and Orr, H.G. 2000. Morphology of riffle-pool sequences in the River Severn, England. *Earth Surface Processes and Landforms* **25**: 369-384.

- Carling, P.A. and McCahon, C.P. 1987. Natural siltation of brown trout (*Salmo trutta* L.) spawning gravels during low-flow conditions. In: Craig, J.F. and Kempner, J.B. (eds) *Regulated streams. Advances in ecology*, Plenum, New York, pp. 229-244.
- Church, M. and Zimmerman, A. 2007. Form and stability of step-pool channels: Research progress. *Water Resources Research* **43** W03415.
- Collins, A.L. and Walling, D.E. 2007a. Fine-grained bed sediment storage within the main channel systems of the Frome and Piddle catchments, Dorset, UK. *Hydrological Processes* **21**: 1448-1459.
- Collins, A.L. and Walling, D.E. 2007b. The storage and provenance of fine sediment on the channel bed of two contrasting lowland permeable catchments, UK. *River Research and Applications* **23**: 429-450.
- Collins, A.L. and Walling, D.E. 2007c. Sources of fine grained sediment recovered from the channel bed of lowland groundwater-fed catchments in the UK. *Geomorphology* **88**:120-138.
- Collins, A.L., Walling, D.E. and Leeks, G.J.L. 2005. Storage of fine-grained sediment and associated contaminants within the channels of lowland permeable catchments in the UK. In *Sediment Budgets 1*, Walling DE, Horowitz A (eds). IAHS Publication No. 291. IAHS Press: Wallingford; 259-268.
- Cotton, J.A., Wharton, G., Bass, J.A.B., Heppell, C.M. and Wootton, R.S. 2006. The effects of seasonal changes to instream vegetation cover on patterns of flow and accumulation of sediment. *Geomorphology* **77**: 320-334.
- Evans, E.C. and Petts, G.E. 1997. Hyporheic temperature patterns within riffles. *Hydrological Sciences Journal* **42**: 199-213.
- Extence, C.A. 1978. The effects of motorway construction on an urban stream. *Environmental Pollution*, **17**, 245-252.
- Farr, I.S. and Clarke, R.T. 1984. Reliability of suspended sediment load estimates in chalk streams. *Archiv für Hydrobiologie*, **102**, 1-19.
- Goody, D.C., Darling, W.G., Abesser, C. and Lapworth, D.J. 2006. Using chlorofluorocarbons (CFCs) and sulphur hexafluoride (SF6) to characterize groundwater movement and residence time in a lowland chalk catchment. *Journal of Hydrology* **330**: 44-52.
- Gooseff, M.N., Anderson, J.K., Wondzell, S., LaNier, J. and Haggerty, R. 2006. A modeling study of hyporheic exchange pattern and the sequence, size and spacing of stream bedforms in mountain stream networks, Oregon, USA (retraction of vol 19, pg2915, 2005). *Hydrological Processes* **20**: 2441-+
- Grapes, T.R., Bradley, C. and Petts, G.E. 2006. Hydrodynamics of floodplain wetlands in a chalk catchment: The River Lambourn, UK. *Journal of Hydrology* **320**: 324-341.
- Greig, S.M., Sear, D.A. and Carling, P.A. 2005a. Fine sediment accumulation in salmon spawning gravels and the survival of incubating salmon progeny: implications for spawning habitat management, *Science of the Total Environment* **344**: 241-258.

- Greig, S. M., Sear, D.A., Smallman, D. and Carling, P.A. 2005b. Impact of clay particles on cutaneous exchange of oxygen across the chorion of Atlantic salmon eggs. *Journal of Fish Biology*. **66**: 1681-1691.
- Greig, S. M., Sear, D.A. and Carling, P.A. 2007. Review of factors influencing the availability of dissolved oxygen to incubating salmon embryos. *Hydrological Processes*, **21**: 323-334.
- Harvey, J.W. and Bencala, K.E., 1993, The effect of streambed topography on surface-subsurface water exchange in mountain catchments, *Water Resources Research* **29**: 89-98.
- Hey, R.D. and Thorne, C.R. 1986. Stable channels with mobile gravel beds. *Journal of Hydraulic Engineering* **112**: 671-686.
- Hill, A.R., Labadia, C.F. and Sanmugadas, K. 1998. Hyporheic zone hydrology and nitrogen dynamics in relation to the streambed topography of a N-rich stream. *Biogeochemistry* **42**: 285-310.
- Lambert, C.P. and Walling, D.E. 1988. Measurement of channel storage of suspended sediment in a gravel-bed river. *Catena* 15:65-80.
- Lawler DM. 1992. Process dominance in bank erosion systems. in *Lowland Floodplain Rivers: Geomorphological Perspectives*, Carling PA, Petts GE (eds). Wiley: Chichester; 117–143.
- Lawler, D.M. 2008. Advances in the continuous monitoring of erosion and deposition dynamics: Developments and applications of the new PEEP-3T system. *Geomorphology*, 93, 17-39.
- Lawler, D.M., Petts, G.E., Foster, I.D.L. and Harper, S. 2006. Turbidity dynamics during spring storm events in an urban headwater river system: The Upper Tame, West Midlands, UK. *Science of the Total Environment* 360: 109-126.
- Leeks, G.J.L. and Marks, S.D. 1997. Dynamics of river sediments in forested headwater streams: Plynlimon. *Hydrology and Earth System Sciences*, **1**, 483-497.
- Leopold, L. B. and Maddock, T. 1953. The hydraulic geometry of stream channels and some physiographic implications, United States Geological Survey Professional Paper 252, 57pp.
- Lewin, J., Macklin, M.G. and Johnstone, E. 2005. Interpreting alluvial archives: sedimentological factors in the British Holocene fluvial record. *Quaternary Science Reviews* **24**: 1873-1889.
- Mainstone, C. 1999. *Chalk Rivers: Conservation and Management*. English Nature/Environment Agency, Peterborough. 184 pp.
- Malard F. and Hervant F. 1999. Oxygen supply and the adaptations of animals in groundwater. *Freshwater Biology* **40**: 1-30.

- Malcolm, I.A., Greig, S.M., Youngson, A.F. and Soulsby, C. 2008. Hyporheic influences on salmon embryo survival and performance in Sear, D.A. & DeVries, P. (ed) Salmonid Spawning habitat in Rivers; Physical controls, biological responses and approaches to remediation, AFS, Bethesda, Maryland, USA, 225-248.
- McDowell-Boyer, L.M., Hunt, J.R. and Sitar, N. 1986. Particle transport through porous media. *Water Resources Research* **22**: 1901-1921.
- McKerchar, A. I., Ibbitt, R. P., Brown, S. L. R. and Duncan, M. J. 1998. Data for Ashley River to test channel network and river basin heterogeneity concepts, *Water Resources Research* **34**: 139–142
- Milan, D. J., Petts, G. E. and Sambrook, H. 2000. Regional variations in the sediment structure of trout streams in southern England: Benchmark data for siltation assessment and restoration. *Aquatic Conservation: Marine and Freshwater Ecosystems*. **10**: 407-420.
- Naden, P., Smith, B., Jarvie, H., Llewellyn, N., Matthiessen, P., Dawson, H., Scarlett, S and Hornby, D. 2003. Siltation in Rivers. A Review of Monitoring Techniques. Conserving Natura 2000 Rivers Conservation Techniques Series No. 6. English Nature, Peterborough. http://www.english-nature.org.uk/LIFEinUKRivers/publications/silt_review.pdf
- Newson, M.D., Pitlick, J. and Sear, D.A. 2002. Running water: Fluvial geomorphology and river restoration, in Perrow, M.R. & Davy, A.J., eds. *Handbook of Ecological Restoration*, Cambridge, Cambridge University Press, , 133 – 152
- Owens, P.N. and Walling, D.E. 2002. The phosphorus content of fluvial sediment in rural and industrialized river basins. *Water Research* **36**: 685-701
- Owens, P.N., Walling, D.E. and Leeks, G.J.L. 1999. Deposition and storage of fine-grained sediment within the main channel of the River Tweed, Scotland. *Earth Surface Processes and Landforms* **24**: 1061-1076.
- Packman, A.I. and Bencala, K.E. 2000. Modeling methods in the study of surface-subsurface hydrologic interactions, in *Streams and Ground Waters*, J.B. Jones , P.J. Mulholland (eds), Academic Press, 115-127.
- Sear D. A. 1993. Fine sediment infiltration into gravel spawning within a regulated river experiencing floods: Ecological implications for salmonids. *Regulated Rivers Research and Management*. **8**: 373-390.
- Sear, D.A., Thorne, C.R. and Newson, M.D. 2004. *Guidebook of Applied Fluvial Geomorphology: Defra/Environment Agency Flood and Coastal Defence R&D Programme*, London, Defra Flood Management Division, 256pp. (R&D Technical Report FD1914).
- Sear, D.A., Frostick, L.B., Rollinson, G. and Lisle, T.E. 2008. The significance and mechanics of fine sediment infiltration and accumulation in gravel spawning beds, in Sear, D.A. & DeVries, P. (ed) *Salmonid Spawning habitat in Rivers; Physical controls, biological responses and approaches to remediation*, AFS, Bethesda, Maryland, USA, 2008, 149-174.

- Soulsby C., Malcolm, I.A. and Youngson, A.F. 2001. Hydrochemistry of the hyporheic zone in salmon spawning gravels: a preliminary assessment in a degraded agricultural stream. *Regulated Rivers, Research & Management* **76**: 651-665.
- Soulsby, C., Malcolm, I.A., Youngson, A.F., Tetzlaff, D., Gibbins, C.N. and Hannah, D.M. 2005. Groundwater-surface water interaction in upland Scottish rivers: hydrological, hydrochemical and ecological implications. *Scottish J. Geol* **41**: 39-49.
- Stanford J. A. and Ward, J.V. 1988. The hyporheic habitat of river ecosystems. *Nature* **335**: 64-66.
- Stanford, J.A. and Ward, J.V. 1993. An ecosystem perspective of alluvial rivers- Connectivity and the hyporheic corridor. *Journal of the North American Benthological Society* **12**: 48-60.
- Thoms, M.C. 1987. Channel sedimentation within the urbanized River Thame, UK. *Regulated Rivers: Research and Management*, **1**, 229-246.
- Turnpenny, A. W. H. and Williams, R.. 1980. Effects of sedimentation on the gravels of an industrial river system. *Journal of Fish Biology*, **17**, 1–693.
- Vannote, R.L., Minshall, G.W., Cummins, K.W., Sedell, J.R. and Cushing, C.E. 1980. The river continuum concept. *Canadian Journal of Fisheries and Aquatic Science* **37**: 130-137
- Walling, D.E. and Amos, C.M. 1999. Source, storage and mobilisation of fine sediment in a chalk stream system. *Hydrological Processes* **13**: 323-340.
- Walling, D.E. and Quine, T.A. 1993. Using Chernobyl-derived radionuclides to investigate the role of downstream conveyance losses in the suspended sediment budget of the River Severn, United Kingdom, *Physical Geography*, **14**: 239-253.
- Walling, D.E., Owens, P.N., Leeks, G.J.L. 1998. The role of channel and floodplain storage in the suspended sediment budget of the River Ouse, Yorkshire, UK. *Geomorphology* **22**: 225-242.
- Walling, D.E., Collins, A.L. and McMellin, G.K. 2003. A reconnaissance survey of the source of interstitial fine sediment recovered from salmonid spawning gravels in England and Wales. *Hydrobiologia* **497**: 91-108.
- Welton, J.S. 1980. Dynamics of sediment and organic detritus in a small chalk stream. *Archiv für Hydrobiologie*, **90**, 162-181.
- Wood, P.J. and Armitage, P.D. 1999. Sediment deposition in a small lowland stream – management implications. *Regulated Rivers: Research and Management*, **15**: 199-210.
- Worman, A., Packman, A.I., Marklund, L., Harvey, J.W. and Stone, S.H. 2007. Fractal topography and subsurface water flows from fluvial bedforms to the continental shelf. *Geophysical Research Letters* **34**: L07402.
- Zimmermann, A.E. and Lapointe, M. 2005 Sediment infiltration traps: their use to monitor salmonid spawning habitat in headwater tributaries of the Cascapédia River, Québec, *Hydrological Processes*, **19 (20)**., 4161-4177.

Chapter 4

- Boano, F., Camporeale, C., Revelli, R., and Ridolfi, L., 2006. Sinuosity-driven hyporheic exchange in meandering rivers. *Geophysical Research Letters*, **33**, L18406, doi:10.1029/2006GL027630.
- Booker, D., Griffiths, J., Goodwin, T., Old, G., Young, A., 2006. Production of a compendium of hyporheic zones. Environment Agency (UK), Science Report SC030155.
- Brunke, M., Gonser, T., 1997. The ecological significance of exchange processes between rivers and groundwater. *Freshwater Biology* **37**: 1–33.
- Butler, J.J., Zlotnik, V.A., and Tsou, M.-S., 2001. Drawdown and stream depletion produced by pumping in the vicinity of a partially penetrating stream. *Ground Water*, **39**, 651-659.
- Calver, A., 2001. Riverbed permeabilities: information from pooled data. *Ground Water*, **39**(4), 546-553.
- Cardenas, M.B., 2008a. The effect of river bend morphology on flow and timescales of surface water–groundwater exchange across pointbars. *J. Hydrology*, **362**, 134–141.
- Cardenas, M.B., 2008b. Surface water-groundwater interface geomorphology leads to scaling of residence times. *Geophysical Research Letters*, **35**, L08402, doi:10.1029/2008GL033753.
- Cardenas, M.B., 2009. A model for lateral hyporheic flow based on valley slope and channel sinuosity. *Water Resources Research*, **45**, W01501, doi:10.1029/2008WR007442
- Cardenas, M.B., and Wilson, J.L., 2006. The influence of ambient groundwater discharge on exchange zones induced by current–bedform interactions. *J. Hydrology*, **331**, 103–109.
- Cardenas, M.B., and Wilson, J.L., 2007a. Exchange across a sediment–water interface with ambient groundwater discharge. *J. Hydrology*, **346**, 69– 80.
- Cardenas, M.B., and Wilson, J.L., 2007b. Dunes, turbulent eddies, and interfacial exchange with permeable sediments. *Water Resources Research*, **43**, W08412, doi:10.1029/2006WR005787.
- Cardenas, M. B., Wilson, J. L., and Haggerty, R., 2008. Residence time of bedform-driven hyporheic exchange, *Advances in Water Resources*, **31**, 1382–1386
- Cardenas, M.B., Wilson, J.L., and Zlotnik, V.A., 2004. Impact of heterogeneity, bed forms, and stream curvature on subchannel hyporheic exchange. *Water Resources Research*, **40**, W08307. doi: 10.1029/2004WR003008.
- Chen, X., 2003. Analysis of pumping-induced stream–aquifer interactions for gaining streams. *J. Hydrology* **275**, 1–11.
- Chen, X., Burbach, M., and Cheng, C., 2008. Electrical and hydraulic vertical variability in channel sediments and its effects on streamflow depletion due to groundwater extraction. *J. Hydrology*, **352**, 250– 266.

- Constantz, J., Thomas, C. L., and Zellweger, G., 1994. Influence of diurnal variations in stream temperature on streamflow loss and groundwater recharge. *Water Resources Research*, **30**, 3253–3264.
- Dahl, M., Nilsson, B., Langhoff, J.H., Refsgaard, J.C., 2007. Review of classification systems and new multi-scale typology of groundwater–surface water interaction. *J. Hydrology*, **344**, 1– 16.
- Dent, C.L., Grimm, N.B., and Fisher, S.G., 2001. Multiscale effects of surface–subsurface exchange on stream water nutrient concentrations. *J. North American Benthological Society*, **20**, 162-181.
- Downing, R.A., Oakes, D.B., Wilkinson, W.B., and Wright, C.E., 1974. Regional development of water resources in combination with surface water. *J. Hydrology*, **22**, 155-177.
- Elliott, A.H., and Brooks, N.H., 1997. Transfer of non-sorbing solutes to a streambed with bedforms: theory. *Water Resources Research*, **33**, 123-136.
- Ellis, P.A., Mackay, R., Rivett, M.O., 2007. Quantifying urban river–aquifer fluid exchange processes: A multi-scale problem. *J. Contaminant Hydrology*, **91**, 58–80.
- Fan, Y., Toran, L., and Schlische, R.W., 2007. Groundwater flow and groundwater–stream interaction in fractured and dipping sedimentary rocks: Insights from numerical models. *Water Resources Research*, **43**, W01409, doi:10.1029/2006WR004864.
- Genereux, D.P., Leahy, S., Mitasova, H., Kennedy, C.D., Corbett, D.R., 2008. Spatial and temporal variability of streambed hydraulic conductivity in West Bear Creek, North Carolina, USA. *J. Hydrology*, **358**, 332– 353.
- Glover, R.E., and C.G. Balmer. 1954. River depletion resulting from pumping a well near a river. *AGU Transactions* 35, no. 3: 468–470.
- Gooseff, M.N., LaNier, J., Haggerty, R., and Kokkeler, K., 2005. Determining in-channel (dead zone) transient storage by comparing solute transport in a bedrock channel–alluvial channel sequence, Oregon. *Water Resources Research*, **41**, W06014, doi:10.1029/2004WR003513.
- Gooseff, M.N., Hall, R.O., and Tank, J.L., 2007. Relating transient storage to channel complexity in streams of varying land use in Jackson Hole, Wyoming. *Water Resources Research*, **43**, W01417, doi:10.1029/2005WR004626
- Harvey, J.W., and Bencala, K.E., 1993. The effect of streambed topography on surface–subsurface water exchange in mountain catchments. *Water Resources Research*, **29**, 89-98.
- Huettel, M., and Gust, G., 1992. Impact of bioroughness on interfacial solute exchange in permeable sediments. *Marine Ecology Progress Series*, **89**, 253-267.
- Hunt, B., 2003. Unsteady stream depletion when pumping from semiconfined aquifer. *J. Hydrologic Engineering*, **8**, 12-19.
- Jonsson, K., Johansson, H., Wörman, A., 2003. Hyporheic exchange of reactive and conservative solutes in streams—tracer methodology and model interpretation. *Journal of Hydrology*, **278**, 153–171.

- Kirchner, J.W., Feng, X., and Neal, C., 2000. Fractal stream chemistry and its implications for contaminant transport in catchments. *Nature*, **403**, 524-527.
- Kirchner, J.W., Feng, X., and Neal, C., 2001. Catchment-scale advection and dispersion as a mechanism for fractal scaling in stream tracer concentrations. *J. Hydrology*, **254**, 82-101.
- Konrad, C.P., 2006. Location and timing of river-aquifer exchanges in six tributaries to the Columbia River in the Pacific Northwest of the United States. *J. Hydrology*, **329**, 444-470.
- Larkin, R.G., and Sharp, J.M., 1992. On the relationship between river-basin geomorphology, aquifer hydraulics, and ground-water flow direction in alluvial aquifers. *Geol. Soc. America Bulletin*, **104**, 1608-1620.
- Malard, F., Tockner, K., Dole-Olivier, M.J., Ward, J.V., 2002. A landscape perspective of surface-subsurface hydrological exchanges in river corridors. *Freshwater Biology*, **47**, 621-640.
- Malcolm, I. A., Soulsby, C., Youngson, A. F., and Petry, J., 2003. Heterogeneity in ground water-surface water interactions in the hyporheic zone of a salmonid spawning stream. *Hydrological Processes*, **17**, 601-617.
- Mertes, L.A.K., 1997. Documentation of the significance of the perirheic zone on inundated floodplains. *Water Resources Research*, **33**, 1749-1762.
- Miller, C.D., Durnford, D., Halstead, M.R., Altenhofen, J., and Flory, V., 2007. Stream depletion in alluvial valleys using the SDF semianalytical model. *Ground Water*, **45**, 506-514.
- Packman, A.I., and Brooks, N.H., 2001. Hyporheic exchange of solutes and colloids with moving bed forms. *Water Resources Research*, **37**, 2591-2605.
- Packman, A.I., Salehin, M., and Zaramella, M., 2004. Hyporheic exchange with gravel beds: basic hydrodynamic interactions and bedform-induced advective flows. *J. Hydraulic Engineering*, **130**, 647-656.
- Poole, G. C., O'Daniel, S. J., Jones, K. L., Woessner, W. W., Bernhardt, E. S., Helton, A. M., Stanford, J. A., Boer, B. R., and Beechie, T. J., 2008. Hydrologic spiralling: the role of multiple interactive flow paths in stream ecosystems. *River Research and Applications*, **24**, 1018-1031.
- Raudkivi, A.J., and Callander, R.A., 1976. *Analysis of groundwater flow*. Edward Arnold, London, 214pp.
- Rehg, K.J., Packman, A.I., and Ren, J., 2005. Effects of suspended sediment characteristics and bed sediment transport on streambed clogging. *Hydrological Processes*, **19**, 413-427.
- Rinaldi, M., Casagli, N., Dapporto, S., and Gargini, A., 2004. Monitoring and modelling of pore water pressure changes and riverbank stability during flow events. *Earth Surface Processes and Landforms*, **29**, 237-254.
- Runkel, R.L., 2002. A new metric for determining the importance of transient storage. *J. North American Benthological Society*, **21**, 529-543.

- Ryan, R.J., and Boufadel, M.C., 2006. Influence of streambed hydraulic conductivity on solute exchange with the hyporheic zone. *Environ Geol.*, DOI 10.1007/s00254-006-0319-9.
- Salehin, M., Packman, A.I., and Wörman, A., 2003. Comparison of transient storage in vegetated and unvegetated reaches of a small agricultural stream in Sweden: seasonal variation and anthropogenic manipulation. *Advances in Water Resources*, **26**, 951–964.
- Schubert, J., 2002. Hydraulic aspects of riverbank filtration—field studies. *J. Hydrology*, **266**, 145–161.
- D. A. Sear, P. D. Armitage and F. H. Dawson, 1999. Groundwater dominated rivers. *Hydrol. Processes*, **13**, 255-276.
- Sophocleous, M.A., 1991. Stream-floodwave propagation through the Great Bend alluvial aquifer, Kansas: field measurements and numerical simulations. *J Hydrology*, **124**, 207–228.
- Sophocleous, M.A., 2002. Interactions between groundwater and surface water: the state of the science. *Hydrogeology J.*, **10**, 52–67.
- Smith, J.W.N., 2005. Groundwater-surface water interactions in the hyporheic zone. Environment Agency (UK) Science Report SC030155/SR1. ISBN: 1844324257.
- Storey, R.G., Howard, K.W.F., and Williams, D.D., 2003. Factors controlling riffle-scale hyporheic exchange flows and their seasonal changes in a gaining stream: a three dimensional groundwater flow model. *Water Resources Research*, **39**, 1034, doi:10.1029/2002WR001367
- Theis, C.V. 1941. The effect of a well on the flow of a nearby stream. *AGU Transactions* **22**, 734–738.
- Tonina, D., and Buffington, J.M., 2007. Hyporheic exchange in gravel bed rivers with pool-riffle morphology: Laboratory experiments and three-dimensional modeling. *Water Resources Research*, **43**, W01421, doi:10.1029/2005WR004328.
- Toth, J., 1970. A conceptual model of the groundwater regime and the hydrogeologic environment. *J. Hydrology* **10**, 164–176.
- Twort, A.C., Ratnayaka, D.D., and Brandt, M.J., 2000. *Water supply* (5th edition). Butterworth-Heinemann, Oxford.
- Vollmer, S., de los Santos Ramos, F., Daebel, H., Ku, G., 2002. Micro scale exchange processes between surface and subsurface water. *J. Hydrology*, **269**, 3–10.
- Wang, W. and Zhang, G., 2007. Numerical simulation of groundwater flowing to horizontal seepage wells under a river. *Hydrogeology J.*, **15**, 1211–1220.
- Winter, T.C., Harvey, J.W., Franke, O.L., and Alley W.M., 1998. Ground water and surface water – a single resource. US Geological Survey Circular 1139.
- White, D. S. 1990: Biological relationships to convective flow patterns within stream beds. *Hydrobiologia* **196**, 149-158.
- Woessner, W.W., 2000. Stream and fluvial ground water interactions: rescaling hydrogeologic thought. *Ground Water*, **38**, 423-429.

- Wondzell, S.M., and Swanson, F.J., 1999. Floods, channel change, and the hyporheic zone. *Water Resources Research*, **35**, 555–567.
- Wörman, A., Packman, A.I., Johansson, H., and Jonsson, K., 2002. Effect of flow-induced exchange in hyporheic zones on longitudinal transport of solutes in streams and rivers. *Water Resources Research*, **38**, NO. 1, 1001, 10.1029/2001WR000769.
- Wörman, A., Packman, A.I., Marklund, L., Harvey, J.W., 2007. Fractal topography and subsurface water flows from fluvial bedforms to the continental shield. *Geophysical Research Letters*, **34**, L07402, doi:10.1029/2007GL029426.
- Wroblicky, G.J., Campana, M. E., Valett, H.M., and Dahm, C.N., 1998. Seasonal variation in surface-subsurface water exchange and lateral hyporheic area of two stream-aquifer systems. *Water Resources Research*, **34**, 317–328.
- Yeh, H.-D., Chang, Y.-C., Zlotnik, V.A., 2008. Stream depletion rate and volume from groundwater pumping in wedge-shape aquifers. *J. Hydrology*, **349**, 501– 511.

Chapter 5

- Atkinson B.L., Grace M.R., Hart B.T. and Vanderkruk K. 2008. Sediment instability affects the rate and location of primary production and respiration in a sand-bed stream. *Journal of the North American Benthological Society* **27**: 581-592.
- Boano F., Camporeale C., Revelli R., and Ridolfi L. 2006. Sinuosity-driven hyporheic exchange in meandering rivers, *Geophysical Research Letters* **33**: 1-4
- Boulton A.J., Findlay S., Marmonier P., Stanley E.H., and Valett H.M.. 1998. The functional significance of the hyporheic zone in streams and rivers. *Annual Review of Ecology and Systematics* **29**: 59-81.
- Boulton A.J. 2007. Hyporheic rehabilitation in rivers: restoring vertical connectivity. *Freshwater Biology* **52**: 632-650.
- Boulton A.J. and Hancock P.J. 2006. River as groundwater dependent ecosystems: a review of degrees of dependency, riverine processes, and management implications. *Australian Journal of Botany* **54**: 133-144.
- Boulton A.J., Fenwick G.D., Hancock P.J. and Harvey M.S. 2008. Biodiversity, functional roles and ecosystem services of groundwater invertebrates. *Invertebrate Systematics* **22**: 103-116.
- Brown L.E., Hannah D.M. and Milner A.M. 2006. Hydroclimatological influences on water column and streambed thermal dynamics in an alpine river system. *Journal of Hydrology* **325**: 1-20.
- Brunke M. 1999. Colmation and depth filtration within streambeds: Retention of particles in the hyporheic interstices. *International Review of Hydrobiology* **84**: 99-117.
- Brunke M. and Gonser T. 1997. The ecological significance of exchange processes between rivers and groundwater. *Freshwater Biology* **37**: 1-33.

- Burkholder B.K., Grant G.E., Haggerty R., Khangaonkar T. and Wampler P.J. 2008. Influence of hyporheic flow and geomorphology on temperature of a large, gravel-bed river, Clackamas River, Oregon, USA. *Hydrological Processes* **22**: 941-953.
- Burrell G.P. and Ledger M.E. 2003. Growth of a stream-dwelling caddisfly (*Olinga feredayi*: Conoesucidae) on surface and hyporheic food resources. *Journal of the North American Benthological Society* **22**: 92-104.
- Cardenas M.B. and Wilson J.L. 2007. Thermal regime of dune-covered sediments under gaining and losing water bodies. *Journal of Geophysical Research* **112**: G04013.
- Claret C. and Fontvielle D. 1997. Characteristics of biofilm assemblages in two contrasted hydrodynamic and trophic contexts. *Microbial Ecology* **34**: 49-57.
- Collier K.J., Wright-Stow A.E. and Smith B.J. 2004. Trophic basis of production for a mayfly in a North Island, New Zealand, forest stream: contributions of benthic versus hyporheic habitats and implications for restoration. *New Zealand Journal of Marine and Freshwater Research* **38**: 310-314.
- Conant B., Cherry J.A. and Gillham R.W. 2004. PCE groundwater plume discharging to a river: influence of the streambed and near-river zone on contaminant distributions, *Journal of Contaminant Hydrology*. **73**, (1-4), pp. 249-279.
- Constantz J., Tyler S.W. and Kwicklis E. 2003. Temperature-profile methods for estimating percolation rates in arid environments. *Vadose Zone Journal* **2**: 12-24.
- Cozzetto K., McKnight D., Nylén T. and Fountain A. 2006. Experimental investigations into processes controlling stream and hyporheic temperatures, Fryxell Basin, Antarctica. *Advances in Water Resources* **29**: 130-153.
- Culver D.C. and Pipan T. 2009. *The Biology of Caves and Other Subterranean Habitats*. Oxford University Press. Oxford.
- Datry, T. and Larned, S.T. 2008. River flow controls ecological processes and invertebrate assemblages in subsurface flowpaths of an ephemeral river reach. *Canadian Journal of Fisheries and Aquatic Sciences* **65**: 1532-1544.
- Datry T., Malard F. and Gibert J. 2005. Response of invertebrate assemblages to increased groundwater recharge rates in a phreatic aquifer. *Journal of the North American Benthological Society* **24**: 461-477.
- Dole-Olivier M.J. Marmonier P. and Befry J.L. 1997. Response of invertebrates to lotic disturbance: Is the hyporheic zone a patchy refugium? *Freshwater Biology* **37**: 257-276.
- Ellis P.A. and Rivett M.O. (2007). Assessing the impact of VOC-contaminated groundwater on surface water at the city scale. *Journal of Contaminant Hydrology* **91**, 107-127.
- Fenoglio S., Bo T. and Bosi G. 2006. Deep interstitial habitat as a refuge for *Agabus paludosus* (Fabricus) (Coleoptera: Dytiscidae) during summer droughts. *Coleopterists Bulletin* **60**: 37-41.

- Feris K.P., Ramsey P.W., Frazar C.F, Rillig M.C., Gannon J.E. and Holben W. E. 2003. Structure and seasonal dynamics of hyporheic zone microbial communities in free-stone rivers of the western United States. *Microbial Ecology* **46**:200-215.
- Findlay S.E.G, Sinsabough R.L., Sobczak W.V. and Hoostal M. 2003. Metabolic and structural response of hyporheic microorganisms to variations in supply of dissolved organic matter. *Limnology and Oceanography* **48**: 1608-1617.
- Findlay S., Strayer D., Goumbala C. and Gould K., 1993. Metabolism of streamwater dissolved organic carbon in the shallow hyporheic zone. *Limnology and Oceanography* **38**: 1493-1499.
- Fisher S.G., Grimm N.B., Marti E., Holmes R.M. and Jones J.B.. 1998. Material spiraling in stream corridors: A telescoping ecosystem model. *Ecosystems* **1**: 19-34.
- Fleckenstein J.H. and Fogg, G.E. 2008. Efficient upscaling of hydraulic conductivity in heterogeneous alluvial aquifers, *Hydrogeology Journal* **16**: 1239-1250
- Fleckenstein J.H., Frei S and Niswonger G.G. 2008. Simulating river aquifer exchange: the missing scale. British Hydrological Society National Meeting on Hyporheic Hydrology, December 2008. Birmingham.
- Fuller C.C. and Harvey J.W. 2000. Reactive uptake of trace metals in the hyporheic zone of a mining-contaminated stream, Pinal Creek, Arizona, *Environmental Science and Technology* **34**: 1150-1155.
- Gandy C.J., Smith J.W.N and Jarvis A.P. 2007. Attenuation of mining-derived pollutants in the hyporheic zone: A review. *Science of The Total Environment* **373**: 435-446.
- Gibert J., Stanford J.A., Dole-Olivier M.-J. and Ward J.V. 1994. Basic attributes of groundwater ecosystems and prospects for research. In: Gibert J., Danielopol D. and Stanford J.A. (eds.) *Groundwater Ecology*. Academic Press, San Diego. 7-40.
- Gooseff M.N., McKnight D.M., Runke R.L. and Vaughn B.H. 2003. Determining long time-scale hyporheic zone flow paths in Antarctic streams. *Hydrological Processes* **17**: 1691-1710.
- Hakenkamp C.C. and Palmer M.A., 2000. The ecology of hyporheic meiofauna. In: *Streams and Ground Waters* (Jones J.B. and Mulholland P.J. eds). Academic Press. London. 307-336.
- Hancock P. 2002. Human impacts on the stream-groundwater exchange zone. *Environmental Management* **29**: 761-781.
- Hannah D.M., Malcolm I.A. and Bradley C. (2009), Seasonal hyporheic temperature dynamics over riffle bedforms, *Hydrological Processes* **23**: 2178-2194.
- Hannah D.M., Malcolm I.A., Soulsby C. and Youngson A.F. 2004. Heat exchanges and temperatures within a salmon spawning stream in the Cairngorms, Scotland: seasonal and sub-seasonal dynamics. *River Research and Applications* **20**: 635-652.
- Hannah D.M., Malcolm I.A., Soulsby C. and Youngson A.F. 2008. A comparison of forest and moorland stream microclimate, heat exchanges and thermal dynamics. *Hydrological Processes* **22**: 919-940.

- Harvey J.W. and Bencala K.E. 1993. The effect of streambed topography on the surface-subsurface water exchange in mountain catchments. *Water Resources Research* **29**: 89–98.
- Hill A.R. and Cardaci M. 2004. Denitrification and organic carbon availability in riparian wetland soils and subsurface sediments. *Soil Science Society of America Journal* **68**: 320-325.
- Jones J.B. and Holmes R.M. 1996. Surface –subsurface interactions in stream ecosystems. *TREE*, 1: 239-242.
- Joyce P., Warren L.L. and Wotton R.S. 2007.. Faecal pellets in streams: their binding, breakdown and utilisation. *Freshwater Biology* **52**: 1868-1880.
- Kasahara T and Wondzell SM. 2003. Geomorphic controls on hyporheic exchange flow in Mountain Streams. *Water Resources Research* **39** (1): 1–14.
- Kasahara T. and Hill A.R. 2008. Modeling the effects of lowland stream restoration projects on stream-subsurface water exchange. *Ecological Engineering* **32**: 310-319.
- Krause S., Jacobs J., Habeck A., Bronstert A. and Zehe E. 2008. Assessing the impact of changes in landuse and management practices on the diffusive pollution and retention of nitrate in a riparian floodplain. *Science of the Total Environment* **389**: 149–164.
- Krause S., Hannah D.M., Fleckenstein J.H. (2009a) Hyporheic hydrology: interactions at the groundwater-surface water interface. *Hydrological Processes* **23** 2103-2107.
- Krause S., Heathwaite A.L., Binley A. and Keenan P. (2009b) Nitrate concentration changes along the groundwater – surface water interface of a small Cumbrian river. *Hydrological Processes*. **23**: 2195-2211.
- Leichfried M. 2007. The energy basis of the consumer community in streams yesterday, today and tomorrow. *International Review of Hydrobiology* **92**: 363-377.
- Malard F., Ferreira D., Doledec S. and Ward J.V. 2003. Influence of groundwater upwelling on the distribution of the hyporheos in a headwater river flood plain. *Archiv für Hydrobiologie* **157**(1): 89-116.
- Malcolm I.A., Soulsby C., Youngson A.F., Hannah D.M., McLaren I.S. and Thorne A. 2004. Hydrological influences on hyporheic water quality: implications for salmon survival. *Hydrological Processes* **18**: 1543-1560.
- Malcolm I.A., Soulsby C., Youngson A.F. and Hannah DM. 2005. Catchment-scale controls on groundwater-surface water interactions in the hyporheic zone: implications for salmon embryo survival. *River Research and Applications* **21**: 977-989.
- Malcolm I.A., Soulsby C. and Youngson A.F.. 2002. Thermal regime in the hyporheic zone of two contrasting salmonid spawning streams. *Fisheries Management and Ecology* **9**: 1-10.
- Mann R.H.K. 1997. Temporal and spatial variations in the growth of 0 group roach (*Rutilus rutilus*) in the river Great Ouse, in relation to water temperature and food availability. *Regulated Rivers: Research and Management* **13**: 277-285.

- McClain M.E., Boyer E.W., C. Dent C.L., Gergel S.E., Grimm N.B., Groffman P.M., Hart S.C., Harvey J.W., Johnston C.A., Emilio Mayorga E., McDowell W.H. and Pinay G. 2003. Biogeochemical hot spots and hot moments at the interface of terrestrial and aquatic ecosystems. *Ecosystems* **6**: 301-312.
- Mermillod-Blondin F. and Rosenberg R. 2006. Ecosystem engineering: the impact of bioturbation on biogeochemical processes in marine and freshwater benthic habitats. *Aquatic Sciences* **68**: 434-442.
- Mermillod-Blondin F., Gaudet J.P., Gerino M., Desrosiers G. and des Chatelliers M.C. 2003. Influence on macroinvertebrate on physico-chemical and microbial processes and hyporheic sediments. *Hydrological Processes* **17**: 779-794.
- Metzler G.M. and Smock L.A. 1990. Storage and dynamics of subsurface detritus in a sand-bottomed stream. *Canadian Journal of Fisheries and Aquatic Sciences* **47**: 588-594.
- Mulholland P.J., Helton A.M., Poole G.C., Hall R.O., Hamilton S.K. Peterson, B.J., Tank, J.L., Ashkenas, L.R., Cooper, L.W., Dahm, C.N., Dodds, W.K., Findlay, S.E.G., Gregory, S.V., Grimm, N.D., Johnson, S.L., McDowell, W.H., Meyer, J.L., Valett, H.M., Webster, J.R., Arango, C.P., Beaulieu, J.J., Bernot, M.J., Burgin, A.J., Crenshaw, C.L., Johnson, L.T., Niederlehner, B.R., O'Brien, J.M., Potter, J.D., Sheibley, R.W., Sobota, D.J., Thomas, S.M. 2008. Stream denitification across biomes and its response to anthropogenic nitrate loading. *Nature* **452**: 202-205.
- Nzengung V.A., Penning H. and O'Niell W. 2004. Mechanistic changes during phytoremediation of perchlorate under different root-zone conditions. *International Journal of Phytoremediation* **6**: 63-83.
- Olsen D.A. and Townsend C.R. 2003. Hyporheic community composition in a gravel-bed stream: influence of vertical hydrological exchange, sediment structure and physiochemistry. *Freshwater Biology* **48**: 1363-1378.
- Packman A.I. and Salehin M. 2003. Relative roles of stream flow and sedimentary conditions in controlling hyporheic exchange. *Hydrobiologia* **494**: 291-297.
- Packman A.I. and Bencala K.E. 2000, Modeling surface - subsurface hydrologic interactions. In: *Streams and Ground Waters* (Jones J.B. and Mulholland P.J. eds). Academic Press. London. 45-80
- Perry S.A. and Perry W.B. 1986. Effects of experimental flow regulation on invertebrate drift and stranding in Flathead and Kootenai Rivers, Montana, USA. *Hydrobiologia* **134**: 171-182.
- Pinay G., Haycock N.E., Ruffinoni C. and Holmes R.M. 1994. The role of denitrification in nitrogen removal in river corridors. In *Global Wetlands: Old World and New*. (Mitsch W.J. ed.) Elsevier, Amsterdam. 107-116.
- Pinay G., O'Keefe T.C., Edwards R.T. and Naiman R.J. (2009). Nitrate removal in the hyporheic zone of a salmon river in Alaska. *River Research and Applications*. **25**: 367-375.

- Puckett L.J., Zamora C., Essaid H., Wolson J.T., Johnson H.M., Brayton M.J. and Vogel J.R.. 2008. Transport and fate of nitrate at the groundwater/surface-water interface. *Journal of Environmental Quality* **37**:1035–1050.
- Robertson A.L., Rundle S.D. and Schmid-Araya J.M. 2000. Putting the meio- into stream ecology: current findings and future directions for lotic meiofauna research. *Freshwater Biology* **44**: 177-183.
- Robertson A.L., Johns T., Smith J.W.N. and Proundlove G.S. 2008 A review of the subterranean aquatic ecology of England and Wales. Environment Agency Science report SC030155/SR20.
- Ryan R.J. and Packman A.I. 2006. Changes in streambed sediment characteristics and solute transport in the headwaters of Valley Creek - an urbanizing watershed. *Journal of Hydrology* **323**: 74-91.
- Sket B. 2008. Can we agree on an ecological classification of subterranean animals? *Journal of Natural History* **42**: 1549-1563.
- Smith J.W.N. 2005. Groundwater – surface water interactions in the hyporheic zone. Environment Agency Science report SC030155/SR1.
- Smock L.A., Gladden J.E., Riekenberg J.L., Smith L.C. and Black C.R. 1992. Lotic macroinvertebrate production in three dimensions: channel surface, hyporheic, and floodplain environments. *Ecology* **73**: 876-886.
- Stanford J.A., and Ward J.V. 1993. An ecosystem perspective of alluvial rivers: connectivity and the hyporheic corridor. *Journal of the North American Benthological Society* **12**: 48-60.
- Stofleth J.M., Shields F.D. and Fox G.A. 2008. Hyporheic and total transient storage in small, sand-bed streams. *Hydrological Processes* **22**: 1885-1894.
- Stubbington R., Wood P.J. and Boulton A.J. 2009. Low flow controls on benthic and hyporheic macroinvertebrate assemblages during a supra-seasonal drought. *Hydrological Processes* **23**: 2252-2264.
- Tillman D.C., Moerke A.H. Ziel C.L. and Lamberti G.A. 2003. Subsurface hydrology and degree of burial affect mass moss and invertebrate colonisation of leaves in a woodland stream. *Freshwater Biology* **48**: 98-107.
- Trimmer M., Sanders I. A. and Heppell K. M. 2009 Carbon and nitrogen cycling in a vegetated lowland chalk river impacted by sediment. *Hydrological Processes* **23**: 2225-2238
- Triska F.J., Duff J.H. and Avanzino R.J. 1993. Patterns of hydrological exchange and nutrient transformation in the hyporheic zone of a gravel-bottom stream – examining terrestrial aquatic linkages. *Freshwater Biology* **29**: 259-274.
- Webb B.W., Hannah D.M., Moore R.D., Brown L.E. and Nobilis F. 2008. Recent advances in stream and river temperature research. *Hydrological Processes* **22**: 902-918.
- Wondzell S.M. 2006. Effect of morphology and discharge on hyporheic exchange flows in two small streams in the Cascade Mountains of Oregon, USA. *Hydrological Processes*, **20**: 267-287.

Wood P.J., Toone J., Greenwood M.T. and Armitage, P.D. 2005. The response of four lotic macroinvertebrate taxa to burial by sediments. *Archiv für Hydrobiologie* **163**: 145-162.

Youngson A.F., Malcolm I.A., Thorley J.L., Bacon P.J. and Soulsby C. 2004. Long-residence groundwater effects on incubating salmonid redds: low hyporheic oxygen impairs embryo development. *Canadian Journal of Fisheries and Aquatic Sciences* **61**: 2278-2287.

Chapter 6

Andrushchyshyn, O. P., Wilson, K. P. & Williams, D. D. (2007) Ciliate communities in shallow groundwater: seasonal and spatial characteristics. *Freshwater Biology*, **52**, 1745-1761.

Barlocher, F. & Murdoch, J. H. (1989) Hyporheic Biofilms - A Potential Food Source For Interstitial Animals. *Hydrobiologia*, **184**, 61-67.

Barlocher, F., Nikolcheva, L. G., Wilson, K. P. & Williams, D. D. (2006) Fungi in the hyporheic zone of a springbrook. *Microbial Ecology*, **52**, 708-715.

Barlocher, F., Seena, S., Wilson, K. P. & Dudley Williams, D. (2008) Raised water temperature lowers diversity of hyporheic aquatic hyphomycetes. *Freshwater Biology*, **53**, 368-379.

Boulton, A. J., Findlay, S., Marmonier, P., Stanley, E. H. & Valett, H. M. (1998) The functional significance of the hyporheic zone in streams and rivers. *Annual Review of Ecology and Systematics*, **29**, 59-81.

Brunke, M. & Fischer, H. (1999) Hyporheic bacteria - relationships to environmental gradients and invertebrates in a prealpine stream. *Archiv Fur Hydrobiologie*, **146**, 189-217.

Cleven, E. J. (2004) Seasonal and spatial distribution of ciliates in the sandy hyporheic zone of a lowland stream. *European Journal of Protistology*, **40**, 71-84.

Cleven, E. J. & Konigs, S. (2007) Growth of interstitial ciliates in association with ciliate bacterivory in a sandy hyporheic zone. *Aquatic Microbial Ecology*, **47**, 177-189.

Craft, J. A., Stanford, J. A. & Pusch, M. (2002) Microbial respiration within a floodplain aquifer of a large gravel-bed river. *Freshwater Biology*, **47**, 251-261.

Earl, J., Hall, G., Pickup, R. W., Ritchie, D. A. & Edwards, C. (2003) Analysis of methanogen diversity in a hypereutrophic lake using PCR-RFLP analysis of mcr sequences. *Microbial Ecology*, **46**, 270-278.

Falkowski, P. G., Fenchel, T. & Delong, E. F. (2008) The microbial engines that drive Earth's biogeochemical cycles. *Science*, **320**, 1034-1039.

Feris, K., Ramsey, P., Frazar, C., Moore, J. N., Gannon, J. E. & Holbert, W. E. (2003a) Differences in hyporheic-zone microbial community structure along a heavy-metal contamination gradient. *Applied and Environmental Microbiology*, **69**, 5563-5573.

- Feris, K. P., Ramsey, P. W., Frazar, C., Rillig, M., Moore, J. N., Gannon, J. E. & Holben, W. E. (2004a) Seasonal dynamics of shallow-hyporheic-zone microbial community structure along a heavy-metal contamination gradient. *Applied and Environmental Microbiology*, **70**, 2323-2331.
- Feris, K. P., Ramsey, P. W., Frazar, C., Rillig, M. C., Gannon, J. E. & Holben, W. E. (2003b) Structure and seasonal dynamics of hyporheic zone microbial communities in free-stone rivers of the western United States. *Microbial Ecology*, **46**, 200-215.
- Feris, K. P., Ramsey, P. W., Rillig, M., Moore, J. N., Gannon, J. E. & Holbert, W. E. (2004b) Determining rates of change and evaluating group-level resiliency differences in hyporheic microbial communities in response to fluvial heavy-metal deposition. *Applied and Environmental Microbiology*, **70**, 4756-4765.
- Finlay, B. J., Maberly, S. C. & Cooper, J. I. (1997) Microbial diversity and ecosystem function. *Oikos*, **80**, 209-213.
- Fischer, H., Kloep, F., Wilzcek, S. & Pusch, M. T. (2005) A river's liver - microbial processes within the hyporheic zone of a large lowland river. *Biogeochemistry*, **76**, 349-371.
- Fischer, H. & Pusch, M. (2001) Comparison of bacterial production in sediments, epiphyton and the pelagic zone of a lowland river. *Freshwater Biology*, **46**, 1335-1348.
- Hackett, G. & Lehr, J. H. (1985) *Iron Bacteria Occurrence, Problems and Control Methods in Water Wells*, National Water Well Association., Worthington OH.
- Hakenkamp, C. C. & Morin, A. (2000) The importance of meiofauna to lotic ecosystem functioning. *Freshwater Biology*, **44**, 165-175.
- Halda-Alija, L., Hendricks, S. P. & Johnston, T. C. (2001) Spatial and temporal variation of *Enterobacter* genotypes in sediments and the underlying hyporheic zone of an agricultural stream. *Microbial Ecology*, **42**, 286-294.
- Hall, G. H., Jones, J. G., Pickup, R. W. & Simon, B. M. (1990) *Methods To Study The Bacterial Ecology Of Fresh-Water Environments*. *Methods in Microbiology*, **22**, 181-209.
- Hall, G. H., Simon, B. M. & Pickup, R. W. (1996) CH₄ production in blanket bog peat: A procedure for sampling, sectioning and incubating samples whilst maintaining anaerobic conditions. *Soil Biology & Biochemistry*, **28**, 9-15.
- Head, I. M., Saunders, J. R. & Pickup, R. W. (1998) Microbial evolution, diversity, and ecology: A decade of ribosomal RNA analysis of uncultivated microorganisms. *Microbial Ecology*, **35**, 1-21.
- Hendricks, S. P. (1993) *Microbial Ecology Of The Hyporheic Zone - A Perspective Integrating Hydrology And Biology*. *Journal of the North American Benthological Society*, **12**, 70-78.
- Hlavacova, E., Rulik, M. & Cap, L. (2005) Anaerobic microbial metabolism in hyporheic sediment of a gravel bar in a small lowland stream. *River Research and Applications*, **21**, 1003-1011.

- John, D. E. & Rose, J. B. (2005) Review of factors affecting microbial survival in groundwater. *Environmental Science & Technology*, **39**, 7345-7356.
- Jones, J. B., Fisher, S. G. & Grimm, N. B. (1995a) Nitrification In The Hyporheic Zone Of A Desert Stream Ecosystem. *Journal of the North American Benthological Society*, **14**, 249-258.
- Jones, J. B., Holmes, R. M., Fisher, S. G. & Grimm, N. B. (1994) Chemoautotrophic Production And Respiration In The Hyporheic Zone Of A Sonoran Desert Stream. *Proceedings of the Second International Conference on Ground Water Ecology*, 329-338.
- Jones, J. B., Holmes, R. M., Fisher, S. G., Grimm, N. B. & Greene, D. M. (1995b) Methanogenesis in Arizona, USA dryland streams. *Biogeochemistry*, **31**, 155-173.
- Konigs, S. & Cleven, E. J. (2007) The bacterivory of interstitial ciliates in association with bacterial biomass and production in the hyporheic zone of a lowland stream. *Fems Microbiology Ecology*, **61**, 54-64.
- Leichtfried, M. (2007) The energy basis of the consumer community in streams yesterday, today and tomorrow. *International Review of Hydrobiology*, **92**, 363-377.
- McClain, M. E., Richey, J. E. & Pimentel, T. P. (1994) Groundwater Nitrogen Dynamics At The Terrestrial-Lotic Interface Of A Small Catchment In The Central Amazon Basin. *Biogeochemistry*, **27**, 113-127.
- Naegeli, M. W. & Uehlinger, U. (1997) Contribution of the hyporheic zone to ecosystem metabolism in a prealpine gravel-bed river. *Journal of the North American Benthological Society*, **16**, 794-804.
- Neubacher, E., Prast, M., Cleven, E. J. & Berninger, U. G. (2008) Ciliate grazing on *Nitrosomonas europaea* and *Nitrospira moscoviensis*: Is selectivity a factor for the nitrogen cycle in natural aquatic systems? *Hydrobiologia*, **596**, 241-250.
- Packroff, G. & Zwick, P. (1998) The ciliate fauna of an unpolluted German foothill stream, the Breitenbach, 2: Quantitative aspects of the ciliates (Ciliophora, Protozoa) in fine sediments. *European Journal of Protistology*, **34**, 436-445.
- Pickup, R. W. (1995) Sampling and detecting bacterial populations in natural environments. In Baumberg, S. Y. J. P. W. W. E. M. H. S. J. R. (Ed.) *Population Genetics of Bacteria*.
- Pickup, R. W., Rhodes, G., Bull, T. J., Arnott, S., Sidi-Boumedine, K., Hurley, M. & Hermon-Taylor, J. (2006) *Mycobacterium avium* subsp. *paratuberculosis* in Lake Catchments, in River Water Abstracted for Domestic Use, and in Effluent from Domestic Sewage Treatment Works: Diverse Opportunities for Environmental Cycling and Human Exposure. *Appl. Environ. Microbiol.*, **72**, 4067-4077.
- Pickup, R. W., Rhodes, G. & Hermon-Taylor, J. (2003) Monitoring bacterial pathogens in the environment: advantages of a multilayered approach. *Current Opinion in Biotechnology*, **14**, 319-325.
- Pusch, M., Fiebig, D., Brettar, I., Eisenmann, H., Ellis, B. K., Kaplan, L. A., Lock, M. A., Naegeli, M. W. & Traunspurger, W. (1998) The role of micro-organisms in the ecological connectivity of running waters. *Freshwater Biology*, **40**, 453-495.

- Ramsing, N. B., Kuhl, M. & Jorgensen, B. B. (1993) Distribution Of Sulfate-Reducing Bacteria, O₂, And H₂S In Photosynthetic Biofilms Determined By Oligonucleotide Probes And Microelectrodes. *Applied and Environmental Microbiology*, **59**, 3840-3849.
- Searcy, K. E., Packman, A. I., Atwill, E. R. & Harter, T. (2006) Deposition of *Cryptosporidium* Oocysts in Streambeds. *Appl. Environ. Microbiol.*, **72**, 1810-1816.
- Sinabaugh, R. L. & Findlay, S. (1995) Microbial-Production, Enzyme-Activity, And Carbon Turnover In Surface Sediments Of The Hudson River Estuar. *Microbial Ecology*, **30**, 127-141.
- Storey, R. G., Fulthorpe, R. R. & Williams, D. D. (1999) Perspectives and predictions on the microbial ecology of the hyporheic zone. *Freshwater Biology*, **41**, 119-130.
- Storey, R. G., Williams, D. D. & Fulthorpe, R. R. (2004) Nitrogen processing in the hyporheic zone of a pastoral stream. *Biogeochemistry*, **69**, 285-313.
- Torsvik, V. & Øvreas, L. (2002) Microbial diversity and function in soil: from genes to ecosystems. *Current Opinion in Microbiology*, **5**, 240-245.
- Triska, F. J., Duff, J. H. & Avanzino, R. J. (1993) The Role Of Water Exchange Between A Stream Channel And Its Hyporheic Zone In Nitrogen Cycling At The Terrestrial Aquatic Interface. *Hydrobiologia*, **251**, 167-184.
- Whitby, C. B., Saunders, J. R., Pickup, R. W. & McCarthy, A. J. (2001) A comparison of ammonia-oxidiser populations in eutrophic and oligotrophic basins of a large freshwater lake. *Antonie Van Leeuwenhoek International Journal of General and Molecular Microbiology*, **79**, 179-188.
- Whitby, C. B., Saunders, J. R., Rodriguez, J., Pickup, R. W. & McCarthy, A. (1999) Phylogenetic differentiation of two closely related *Nitrosomonas* spp. that inhabit different sediment environments in an oligotrophic freshwater lake. *Applied and Environmental Microbiology*, **65**, 4855-4862.
- Wielinga, B., Benner, S., Brick, C., Moore, J. & Gannon, J. (1994) Geomicrobial Profile Through The Hyporheic Zone Of A Historic Mining Flood Plain. *Proceedings of the Second International Conference on Ground Water Ecology*, 267-276.

Chapter 7

- Alderdice, D.W., W.P. Wickett, and J.R. Brett. 1958. Some effects of exposure to low dissolved oxygen levels on Pacific salmon eggs. *Canadian Journal of Fisheries and Aquatic Sciences* **15**:229–250.
- Alonso C.V., F.D. Theurer, and D.W. Zachmann. 1996. Sediment intrusion and dissolved oxygen transport model-SIDO. U.S. Department of Agriculture, Agriculture Research Service, National Sedimentation Library, Technical Report 5, Oxford, Mississippi.
- Chapman, D.W. 1988. Critical review of variables used to define effects of fines in redds of large salmonids. *Transactions of the American Fisheries Society* **117**:1–21.

- Coble, D.W. 1961. Influence of water exchange and dissolved oxygen in redds on survival of steelhead trout embryos. *Transactions of the American Fisheries Society* **90**:469–474.
- Crisp, D.T. 1988. Prediction, from temperature, of eyeing, hatching and 'swim-up' times for salmonid embryos. *Freshwater Biology* **19**:41–48.
- Crisp, D.T. 1990. Water temperature in a stream gravel bed and implications for salmonid incubation. *Freshwater Biology* **23**:601–612.
- DeVries, P. 1997. Riverine salmonid egg burial depths: review of published data and implications for scour studies. *Canadian Journal of Fisheries and Aquatic Sciences* **54**:1685–1698.
- Elliott, J.M., U.H. Humpesch, and M.A. Hurley. 1987. A comparative study of eight mathematical models for the relationship between water temperature and hatching time of eggs of freshwater fish. *Archiv fur Hydrobiologie*, **109**:257-277
- Elliott, J.M., and M.A. Hurley. 1998. An individual based model for predicting the emergence period of sea trout fry in a lake district stream. *Journal of Fish Biology* **53**:414–433.
- Everest, F.L., R.L. Beschta, J.C. Scrivener, K.V. Koski, J.R. Sedell, and C.F. Cederholm. 1987. Fine sediment and salmonid production: a paradox. Pages 98–142 in E.O. Salo and T.W. Cundy, editors. *Streamside management: forestry and fishery interactions*. University of Washington, Institute of Forest Resources, Contribution 57, Seattle.
- Frost W.E. and Brown M.E. 1967. *The Trout*. London: Collins, 286 pp
- Geist, D.R., and Dauble, D.D. 1998. Redd site selection and spawning habitat use by fall Chinook salmon: the importance of geomorphic features in large rivers. *Environmental Management* **22(5)**: 655–669.
- Geist D. R. (2000) Hyporheic discharge of river water into fall chinook salmon (*Oncorhynchus tshawytscha*) spawning areas in the Hanford Reach, Columbia River. *Canadian Journal of Fisheries and Aquatic Science* **57** 1647-1656
- Gibbins, C., J. Shellberg, H. Moir, and C. Soulsby. 2008. Hydrological influences on adult salmonid migration, spawning, and embryo survival. Pages 195–224 in D.A. Sear and P. DeVries, editors. *Salmonid spawning habitat in rivers: physical controls, biological responses, and approaches to remediation*. American Fisheries Society, Symposium 65, Bethesda, Maryland.
- Greig S.M. 2004. An investigation into processes and factors affecting the ability of U.K. spawning gravels to support the respiratory requirements of Atlantic salmon (*Salmo salar*) embryos. Doctoral dissertation. University of Southampton, Southampton, Hampshire, UK.
- Groves, P.A., and J.A. Chandler. 2005. Habitat quality of historic Snake River fall Chinook salmon spawning locations and implications for incubation survival. Part 2: intra-gravel water quality. *Rivers Research and Applications* **21**:469–483.

- Hamor, T., and E.T. Garside. 1976. Developmental rates of embryos of Atlantic salmon, *Salmo salar* L., in response to various levels of temperature, dissolved oxygen, and water exchange. *Canadian Journal of Zoology* **54**:1912–1917.
- Hansen, E.A. 1975. Some effects of groundwater on brown trout redds. *Transactions of the American Fisheries Society* **1**:100–110.
- Hanrahan, T.P., D.R. Geist, and E.V. Arntzen 2005. Habitat quality of historic Snake River fall Chinook salmon spawning locations and implications for incubation survival. Part 1: substrate quality. *Rivers Research and Applications* **21**: 455-467.
- Hartmann, U. 1988. Probleme der Eientwicklung der Meerforelle in der Stör—Vorschläge zu einer Lösung. *Arbeiten des deutschen Fischerei-Verbandes* **46**, 72–94.
- Humpesch, U.H. 1985. Inter-and intra-specific variation in hatching success and embryonic development of five species of salmonids and thymallus thymallus. *Archiv fur Hydrobiologie*, **104**, 129-144.
- Ingendahl, D. 2001. Dissolved oxygen concentration and emergence of sea trout fry from natural redds in tributaries of the River Rhine. *Journal of Fish Biology* **58**:325–341.
- Kondolf, G.M., M.J. Sale, and M.G. Wolman, 1993. Modification of fluvial gravel size by spawning salmonids. *Water Resources Research* **29(7)**:2265–2274.
- Lapointe, M.F., Bergeron, N.E., Bérubé, F., Pouliot, M.-A. and Johnston, P. 2004. Interactive effects of substrate sand and silt contents, redd-scale hydraulic gradients, and interstitial velocities on egg-to-emergence survival of Atlantic salmon (*Salmo salar*). *Canadian Journal of Fisheries and Aquatic Sciences*, **61**:2271-2277.
- Maitland, P.S. and R.N. Campbell. 1992. *Freshwater Fishes of the British Isles*. Harper Collins, London, 368pp.
- Malcolm, I.A., A. Youngson, and C. Soulsby. 2003a. Survival of salmonid eggs in gravel bed streams: effects of groundwater–surface water interactions. *River Research and Applications* **19**:303–316.
- Malcolm, I.A., C. Soulsby, A. Youngson, and J. Petry. 2003b. Heterogeneity in ground water–surface water interactions in the hyporheic zone of a salmonid spawning stream. *Hydrological Processes* **17**:601–617.
- Malcolm, I.A., C. Soulsby, A.F. Youngson, D.M. Hannah, I.S. McLaren, and A. Thorne. 2004. Hydrological influences on hyporheic water quality: implications for salmon egg survival. *Hydrological Processes* **18**:1543–1560.
- Malcolm, I.A., C. Soulsby, A.F. Youngson, and D.M. Hannah. 2005. Catchment scale controls on groundwater–surface water interactions in the hyporheic zone: implications for salmon embryo survival. *Rivers Research and Applications* **21**:977–98.
- Malcolm, I.A., C. Soulsby, and A. Youngson. 2006. High frequency logging technologies reveal state dependant hyporheic process dynamics: implications for hydroecological studies. *Hydrological Processes* **20**:615–622.

- Malcolm I.A., S. Greig, A.F. Youngson, and C. Soulsby. 2008. Hyporheic influences on salmon embryo survival and performance Pages 225–248 in D.A. Sear and P. DeVries, editors. Salmonid spawning habitat in rivers: physical controls, biological responses, and approaches to remediation. American Fisheries Society, Symposium 65, Bethesda, Maryland.
- Malcolm, I.A., C. Soulsby, A.F. Youngson and D. Tetzlaff. 2009. Fine scale variability of hyporheic hydrochemistry in salmon spawning gravels with contrasting groundwater-surface water interactions. *Hydrogeology Journal* **17**:161-174.
- Mann R.H.K., J.H. Blackburn and W.R.C. Beaumont. 1989. The ecology of brown trout, *Salmo trutta*, in English chalk streams. *Freshwater Biology* **21**: 57–70.
- Naden, P., B. Smith, H. Jarvie, N. Llewellyn, P. Matthiessen, H. Dawson, P. Scarlett, and D. Hornby. 2002. Life in UK rivers. Methods for the assessment and monitoring of siltation in SAC rivers. Part 1: summary of available techniques. Centre for Ecology and Hydrology Wallingford, Oxfordshire, UK.
- Ottaway, E. M., P. A. Carling, A. Clarke and N. A. Reader (1981). Observations on the structure of brown trout, *Salmo trutta* Linnaeus, redds. *Journal of Fish Biology* **19** (5): 593-607
- Phillips, R.W. and H.J. Campbell. 1962. The embryonic survival of coho salmon and steelhead trout as influenced by some environmental conditions in gravel beds. *Pacific Marine Fisheries Commission Annual Report* **14**:60–73.
- Rubin J-F., and C. Glimsater. 1996. Egg to fry survival of the sea trout in some streams of Gotland. *Journal of Fish Biology* **48**:585–606.
- Sear, D.A. and DeVries, P., editors. 2008. Salmonid spawning habitat in rivers: physical controls, biological responses, and approaches to remediation. American Fisheries Society, Symposium 65, Bethesda, Maryland.
- Sear, D.A., P. DeVries, and S. Greig. 2008a. The Science and practice of spawning habitat remediation. Pages 1–14 in D.A. Sear and P. DeVries, editors. Salmonid spawning habitat in rivers: physical controls, biological responses, and approaches to remediation. American Fisheries Society, Symposium 65, Bethesda, Maryland.
- Sear, D.A., L.B. Frostick, G Rollinson, and T.E. Lisle. 2008b. The significance and mechanics of fine-sediment infiltration and accumulation in gravel spawning beds. Pages 149–174 in D.A. Sear and P. DeVries, editors. Salmonid spawning habitat in rivers: physical controls, biological responses, and approaches to remediation. American Fisheries Society, Symposium 65, Bethesda, Maryland.
- Shields, B.A., D.N. Stubbing, D.W. Summers and N. Giles. 2005. Temporal and spatial segregation of spawning by wild and farm-reared brown trout, *Salmo trutta* L., in the River Avon, Wiltshire, UK. *Fisheries Management and Ecology* **12**: 77–79
- Shumway, S.J., C.E. Warren, and P. Doudoroff. 1964. Influence of oxygen concentration and water movement on the growth of steelhead trout and Chinook salmon embryos at different water velocities. *Transactions of the American Fisheries Society* **93**:342–356.

- Silver S.J., C.E. Warren, and P. Doudoroff. 1963. Dissolved oxygen requirements of developing steelhead trout and Chinook salmon embryos at different velocities. *Transactions of the American Fisheries Society* **92**:327–343.
- Sowden, T.K., and G. Power. 1985. Prediction of rainbow trout embryo survival in relation to groundwater seepage and particle size of spawning substrates. *Transactions of the American Fisheries Society* **114**:804–812.
- Taggart, J. B., I. S. McLaren, W. D. Hay, J. H. Webb, and A. F. Youngson. 2001. Spawning success in Atlantic salmon (*Salmo salar* L.): a long-term DNA profiling-based study conducted in a natural stream. *Molecular Biology* **10**:1047–1060.
- Vaux, W.G. 1968. Intragravel flow and interchange of water in a streambed. *Fishery Bulletin* **66**:479–489.
- Youngson, A.F., I.A. Malcolm, J. Thorley, P.J. Bacon, and C. Soulsby. 2004. Long-residence groundwater effects on incubating salmonid eggs: low hyporheic oxygen impairs embryo development and causes mortality. *Canadian Journal of Fisheries and Aquatic Sciences* **61**:2278–2287.

Chapter 8

- Acworth, R.I. and Dasey, G.R. 2003. Mapping of the hyporheic zone around a tidal creek using a combination of borehole logging, borehole electrical tomography and cross-creek electrical imaging, New South Wales, Australia. *Hydrogeology Journal*, **11**(3): 368-377.
- Addy, K., Kellogg, D.Q., Gold A.J., Groffman, P.M., Ferendo, G., Sawyer, C. 2002. In situ push-pull method to determine ground water denitrification in riparian zones. *Journal of Environmental Quality*, **31**: 1017-1024.
- Adkins S. C., Winterbourn, M.J. 1999. Vertical distribution and abundance of invertebrates in two New Zealand stream beds: a freeze coring study. *Hydrobiologia*. **400**: 55-62.
- Baker, M.A., Dahm, C.N., Valett, H.M. 2000. Anoxia, Anaerobic Metabolism, and Biogeochemistry of the Stream-water-Ground-water Interface. In: J.H. Thorp (Editor), *Streams and ground waters*. Academic Press, New York, pp. 259-283.
- Bartram, J., Ballance, R. 1996. *Water Quality Monitoring - A practical guide to the design and implementation of freshwater quality studies and monitoring programmes*. Taylor & Francis.
- Baxter J.S., McPhail, J.D. 1999. The influence of redd site selection, groundwater upwelling, and over-winter incubation temperature on survival of bull trout (*Salvelinus confluentus*) from egg to alevin. *Canadian Journal of Zoology*, **77**:1233-1239.
- Berg, P., MCGlathery, K.J. 2001. A high-resolution pore water sampler for sandy sediments. *Limnology and Oceanography*, **46**(1): 203-210.

- Bou, C., Rouch, R. 1967. Un nouveau champ de recherches sur la faune aquatique souterraine. *Comptes Rendus de l'Académie des Sciences de Paris*. 265: 369-370.
- Boulton A.J., Dole-Oliver M., Marmonier P. 2004. Effects of sample volume and taxonomic resolution on assessment of hyporheic assemblage composition sampled using a Bou-Rouch pump. *Archiv Fur Hydrobiologie*. **159**(3): 327-355.
- Bowden, W.B., Glime, J.M., Riis, T. 2006. Macrophytes and Bryophytes. In: F.R. Hauer and G.A. Lamberti (Editors), *Methods in stream ecology*. Academic Press, New York, pp. 119-142.
- Bradford, J.H., McNamara, J.P., Bowden, W., Gooseff, M.N. 2005. Measuring thaw depth beneath peat-lined arctic streams using ground-penetrating radar. *Hydrological Processes*, **19**(14): 2689-2699.
- Bridge, J.W. 2005. High resolution in-situ monitoring of hyporheic zone biogeochemistry. SCHO0605BJCO-E-P, Environment Agency, Bristol.
- Brodie, R., Sundaram, B., Tottenham, R., Hostetler, S., Ransley, T. 2007. An overview of tools for assessing groundwater-surface water connectivity, Bureau of Rural Sciences, Canberra.
- Carr, G.M., Chambers, P.A. 1998. Macrophyte growth and sediment phosphorus and nitrogen in Canadian prairie river. *Freshwater Biology*, **39**: 525–536.
- Cowx, I.G., Harvey, J.P., Noble, R.A., Nunn, A.D. 2009. Establishing survey and monitoring protocols for the assessment of conservation status of fish populations in river Special Areas of Conservation in the UK. *Aquatic Conservation: Marine and Freshwater Ecosystems*, **19**: 96-103.
- Crook, N., Binley, A. Knight, R. Robinson, D.A., Zarnetske, J., Haggerty, R. 2008. Electrical resistivity imaging of the architecture of substream sediments, *Water Resour. Res.*, **44**, W00D13, doi:10.1029/2008WR006968.
- Dahm, C.N., Valett, H.M., Baxter, C.V., Woessner, W.W. 2006. Hyporheic zones. In: F.R. Hauer and G.A. Lamberti (Editors), *Methods in stream ecology*. Academic Press, New York, pp. 119-142.
- Davy-Bowker, J., Sweeting, W., Wright, N., Clarke, R.T., Arnott S. 2006. The distribution of benthic and hyporheic macroinvertebrates from the heads and tails of riffles. *Hydrobiologia*. **563**: 109-123.
- Duff, J.H., Triska, F.J. 2000. Nitrogen biogeochemistry and surface-subsurface exchange in streams. In: J.B.M. Jones, P.J. (Editor), *Streams and Ground Waters*. Academic Press, San Diego, pp. 197-220.
- Durand, V., Aller, M-F., Greswell, R.B., Rivett, M.O., Mackay, R., Smith, J.W., Tellam, J.H., Whelan, J., 2007. Natural attenuation potential of the urban hyporheic zone: preliminary results before the field experiment under controlled hydrodynamic conditions, 2nd SWITCH Scientific Meeting, Tel-Aviv.

- Elgin, I., Roeck, U., Robach, F., Tremolieres, M. 1997. Macrophyte biological methods used in the study of the exchange between the Rhine River and the groundwater. *Water Research*. **31**(3): 503-514.
- Fetter, C.W. 2001. *Applied Hydrogeology*. Pearson Education International, Upper Saddle River, New Jersey, 598 pp.
- Freeze, R.A., Cherry, J.A. 1979. *Groundwater*. Prentice-Hall, Inc., Englewood Cliffs, NJ, 604 pp.
- FreshwaterLife. 2009. Hypogean Crustacea Recording Scheme. Sampling Methodologies. [online]. [Accessed 4 August 2009]. <http://www.freshwaterlife.org/hcrs/sampling>.
- Geist, D.R., and D.D. Dauble. 1998. Redd site selection and spawning habitat use by fall chinook salmon: the importance of geomorphic features in large rivers. *Environmental Management* **22**:655-669.
- Gibert, J. 2001. Protocols for the assessment and conservation of aquatic life in the subsurface (PASCALIS): a European project (EVK2-CT-2001-00121). <http://www.pascalis-project.com>.
- Grant, J.D., Soulsby, C., Malcolm, I.A., Gibbins, C. 2007. Groundwater influence on the ecological integrity of hyporheic invertebrate communities in upland streams. <http://www.abdn.ac.uk/~geo473/Poster1.pdf>
- Haggerty, R., Argerich, A. and Martí, E. 2008. Development of a "smart" tracer for the assessment of microbiological activity and sediment-water interaction in natural waters: the resazurin-resorufin system. *Water Resources Research*, 44.
- Hahn, H. J. 2005. Unbaited traps – a new method of sampling stygofauna. *Limnologica*, **35**(4): 248–261.
- Hancock, P.J. and Boulton, A.J. 2009. Sampling groundwater fauna: efficiency of rapid assessment methods tested in bores in eastern Australia. *Freshwater Biology*, **54**(4):902-917.
- Hansen, K.L., Jakobsen, R. and Postma, D. 2001. Methanogenesis in a shallow sandy aquifer, Rømø, Denmark. *Geochimica and Cosmochimica Acta*, 65(17): 2925-2935.
- Harvey, W.H., Wagner, B.J. 2000. Quantifying hydrologic interactions between streams and their subsurface hyporheic zones. In: J.B.M. Jones, P.J. (Editor), *Streams and Ground Waters*. Academic Press, San Diego, pp. 3-44.
- Hayashi, M., Rosenberry, D.O. 2001. Effects of ground water exchange on the hydrology and ecology of surface water. *Ground Water*. **40**(3): 309-316.
- Hill, M.T.R. 1999. A freeze-corer for simultaneous sampling of benthic macroinvertebrates and bed sediment from shallow streams. *Hydrobiologia*, **412**: 213-215.

- Kalbus, E., Reinstorf, F., Schirmer, M. 2006. Measuring methods for groundwater-surface water interactions: a review. *Hydrology and Earth System Sciences*, **10**: 873-887.
- Kelly, M., Juggins, S., Guthrie, R., Pritchard, S., Jamieson, J., Rippey, B., Hirst, H., Yallop, M. 2008. Assessment of ecological status in U.K. rivers using diatoms. *Freshwater Biology*, **53**: 403-422.
- Knapp, R. 1984. *Sampling Methods and Taxon Analysis in Vegetation Science*. W. Junk, The Hague
- Landon, M.K., Rus, D.L. and Harvey, F.E. 2001. Comparison of instream methods for measuring hydraulic conductivity in sandy streambeds. *Ground Water*, **39**(6): 870-885.
- Lautz, L.K., Siegel, D.I. 2007. The effect of transient storage on nitrate uptake lengths in streams: an inter-site comparison. *Hydrological Processes*, **21**: 3533-3548.
- Lear, G., Boothroyd, I.K.G., Turner, S.J., Roberts, K., Lewis, G.D. 2009. A comparison of bacteria and benthic invertebrates as indicators of ecological health in streams. *Freshwater biology*, **54**: 1532-1543.
- Li, H.W., Li, J.L. 2006. Role of fish assemblages in stream communities. In: F.R. Hauer and G.A. Lamberti (Editors), *Methods in stream ecology*. Academic Press, New York, pp. 489-514.
- Lyford, F.P., Willey, R.E., Clifford, S. 2000. Field tests of polyethylene-membrane diffusion samplers for characterizing volatile organic compounds in stream-bottom sediments, Nyanza chemical waste dump superfund site, Ashland, Massachusetts, U.S. Geological Survey, Northborough.
- Malcolm I.A, Youngson A.F, Soulsby C. 2003. Survival of salmonid eggs in a degraded gravel-bed stream: Effects of groundwater-surfacewater interactions. *River Research and Applications*. **19**(4): 303-316.
- Mullinger, N.J., Binley, A.M., Pates, J.M., Crook, N.P. 2007. Radon in Chalk streams: Spatial and temporal variation of groundwater sources in the Pang and Lambourn catchments, UK. *Journal Of Hydrology*, **339**(3-4): 172-182.
- Neff, B.P., Piggott, A.R., Sheets, R.A. 2005, Estimation of shallow ground-water recharge in the Great Lakes Basin: U.S. Geological Survey Scientific Investigations Report 2005-5284, 20 p.
- Odong, J. 2007. Evaluation of empirical formulae for determination of hydraulic conductivity based on grain-size analysis. *Journal of American Science*, **3**(3): 54-60. <http://www.americanscience.org/journals/am-sci/0303/10-0284-Odong-Evaluation-am.pdf>
- Orr CH, Rogers KL, Stanley EH. 2006. Channel morphology and P uptake following removal of a small dam. *Journal Of The North American Benthological Society* **25**(3): 556-568.

- Palmer M.A., Strayer D.L., Rundle S.D. 2006. Meiofauna. In: F.R. Hauer and G.A. Lamberti (Editors), *Methods in stream ecology*. Academic Press, New York, pp. 415-433.
- Pepin D.M, Hauer F.R. 2002. Benthic responses to groundwater-surface water exchange in 2 alluvial rivers in northwestern Montana. *Journal of the North American Benthological Society*. 21(3): 370-383.
- Pinay, G., T.C. O'Keefe, Edwards, R.T., Naiman R.J. 2008. "Nitrate removal in the hyporheic zone of a salmon river in Alaska." *River Research And Applications*, DOI: 10.1002/rra.1164.
- Quattrocchi, F., Di Stefano, G., Pizzino, L., Romeo, G., Scarlato, P., Sciacca, U. and Urbini, G. 2000. Geochemical monitoring system II prototype (GMS II) installation at the "Acquq Difesa" well within the Etna region: first data during the 1999 volcanic crisis. **101**(3-4): 273-306.
- Rivett M.O., Ellis P.A., Greswell R.B., Ward R.S., Roche R.S., Cleverly M.G., Walker C., Conran D., Fitzgerald P.J., Willcow T., Dowle J. 2008. Cost-effective mini drive-point piezometers and multilevel samplers for monitoring the hyporheic zone. *Quarterly Journal of Engineering Geology and Hydrogeology*, **41**: 49-60.
- Robertson, A.L., Rundle, S.D., Schmid-Araya, J.M. 2000. Putting the meio- into stream ecology: Current findings and future directions for lotic meiofaunal research. *Freshwater Biology*. **44**: 177-183.
- Rosenberry, D.O., LaBaugh, J.W. 2008. Field techniques for estimating water fluxes between surface water and ground water: U.S. Geological Survey Techniques and Methods 4–D2, 128 p.
- Rundle, S.D., Bilton, D.T., Galassi, D., Shiozawa, D.K. 2002. The geographical ecology of freshwater meiofauna. In S.D, Rundle, A.L. Robertson, and J.M. Schmid-Araya (editors) *Freshwater Meiofauna*. Backhuys Publishers, Leiden, The Netherlands, pp: 279-294.
- Schmidt, S.I., Hahn H.J., Watson G.D., Woodbury R.J., Hatton T.J. 2004. Sampling fauna in stream sediments as well as groundwater using one net sampler. *Acta Hydrochimica et Hydrobiologica*, **32**(2): 131-137.
- Schmidt, C., Conant JR. B., Bayer-Raich, M., Schirmer M. 2007. Evaluation and field-scale application of an analytical method to quantify groundwater discharge using mapped streambed temperatures. *Journal of Hydrology*. **347**: 292-307.
- Schumacher, B. (2002). Methods for the determination of total organic carbon (TOC) in soils and sediments, US Environment Protection Agency: 23p.
<http://www.epa.gov/esd/cmb/research/papers/bs116.pdf>
- Selker, J.S., Thévenaz, L., Huwald, H., Mallet, A., Luxemburg, van de Giesen, Stejskal, M., Zeman, J., Westhoff, M. 2006. Distributed fiber optic temperature sensing for hydrologic systems. *Water Resource Research* **42**, W12202, doi:10.1029/2006WR005326.

- Sheibley, R.W., Duff, J.H., Jackman, A.P., Triska, F.J. 2003. Inorganic nitrogen transformations in the bed of the Shingobee river, Minnesota: integrating hydrologic and biological processes using sediment perfusion cores. *Limnology and Oceanography*, **48**(3): 1129-1140.
- Smith, J.W.N., Lerner, D.N. 2008. Geomorphologic control on pollutant retardation at the groundwater-surface water interface. *Hydrological processes*, **22**(24): 4679-4694.
- Stonestrom, D.A., Constantz, J. 2003. Heat as a tool for studying the movement of groundwater near streams. Circular 1260. <http://pubs.usgs.gov/circ/2003/circ1260/>
- Storey, AW, Edward EHD, Gazey, P. 1991. Surber and kick sampling—A comparison for the assessment of macroinvertebrate community structure in streams of south-western Australia. *Hydrobiologia*. **211**(2): 111-121.
- Vaccaro, J.J., Maloy, K.J. 2006. A thermal profile method to identify potential groundwater discharge areas and preferred salmonid habitats for long river reaches. U.S. GEOLOGICAL SURVEY Scientific Investigations Report 2006-5136. <http://pubs.usgs.gov/sir/2006/5136/>
- Van der Maarel, E. 1975. The Braun-Blanquet approach in perspective. *Plant ecology*. **30**(3): 1573-5052.
- Vukovic, M., Soro, A. 1992. Determination of hydraulic conductivity of porous media from grain-size composition, Water Research Publication (1992).
- Weight, W.D., Sonderegger, J.L. 2001. *Manual of Applied Field Hydrogeology*. New York: McGraw-Hill.
- White, D.S., Hendricks, S.P. 2000. Lotic macrophytes and surface-subsurface exchange processes, pages 363-379. In: J.B.M. Jones, P.J. (Editor), *Streams and Ground Waters*. Academic Press, San Diego, pp. 363-379.
- Wondzell, SM. 2006. Effect of morphology and discharge on hyporheic exchange flows in two small streams in the Cascade Mountains of Oregon, USA. *Hydrological Processes*, **20**(2): 267-287.

Chapter 9

- BGS, 2004. User's manual for the groundwater flow model ZOOMQ3D. British Geological Survey Internal Report IR/04/140.
- BGS & Environment Agency, 2008. Numerical Modelling of the Impact of Groundwater Abstraction on River Flows. Environment Agency Science Report SC030233/SR1 British Geological Survey Report OR/08/017.

- Cardenas MB, Wilson JT. 2006. The influence of ambient groundwater discharge on exchange zones induced by current-bedform interactions *Journal of Hydrology* **331**: 103-109.
- Conant, B., Cherry, J.A. and Gillham, R.W., 2004. A PCE groundwater plume discharging to a river: influence of the streambed and near-river zone on contaminant distributions. *Journal of Contaminant Hydrology* **73**, 249-279.
- Environment Agency, 2002. Resource Assessment and Management Framework Report and User Manual (Version 3), R&D Technical Manual W6-066M.
- Environment Agency, 2004. IGARF1 v4 User Manual. Environment Agency Report NC/00/28.
- Environment Agency, 2006. SIMCAT9.4 - A Guide and Reference for Users. Environment Agency of England and Wales.
- Environment Agency, 2007a. Hydrogeological impact appraisal for groundwater abstractions. Science Report: SC040020/SR2.
- Environment Agency, 2007b. Hydrogeological impact appraisal for dewatering abstractions Science Report – C040020/SR1.
- Environment Agency, 2008. Numerical Modelling of the Impact of Groundwater Abstraction on River Flows. Environment Agency Science Report SC030233/SR1.
- Ewen, J., Parkin, G. & O'Connell, P. E. 2000 Shetran: Distributed river basin flow and transport modeling system. *Journal of Hydrologic Engineering* **5**, 250-258.
- Flynn, N.J., Paddison, T. and Whitehead, P.G., 2002. INCA Modelling of the Lee System: strategies for the reduction of nitrogen loads. *Hydrology And Earth System Sciences*, **6**(3): 467-483.
- Jenkins, C.T., 1968. Techniques for computing rate and volume of stream depletion by wells. *Ground Water*, **6**(2), 37-46.
- Jones, KL, Poole, GC, Woessner, WW, Vitale, MV, Boer, BR, O'Daniel, SJ, Thomas, SA and Geffen, BA, 2008. Geomorphology, hydrology, and aquatic vegetation drive seasonal hyporheic flow patterns across a gravel-dominated floodplain. *Hydrological Processes* **22**: 2105-2113.
- Hantush, M.S., 1965. Well near stream with semipervious beds. *Journal of Geophysical Research*, **70**(12): 2829-2838.
- Harbaugh, A.W., 2005, MODFLOW-2005, the U.S. Geological Survey modular groundwater model -- the Ground-Water Flow Process: U.S. Geological Survey Techniques and Methods 6-A16.
- Hattermann, F.F., Krysanova, V., Habeck, A. and Bronstert, A., 2006. Integrating wetlands and riparian zones in river basin modelling. *Ecological Modelling*, **199**(4): 379-392.
- Hattermann, F.F., Krysanova, V. and Hesse, C., 2008. Modelling wetland processes in regional applications. *Ecological Modelling*, **53**(5): 1001-1012.

- Hunt, B., 1999. Unsteady stream depletion from ground water pumping. *Ground Water*, **37**(1): 98-102.
- Krysanova, V., Muller-Wohlfeil, D.I. and Becker, A., 1998. Development and test of a spatially distributed hydrological water quality model for mesoscale watersheds. *Ecological Modelling*, **106**(2-3): 261-289.
- Krysanova, V., Wechsung, F., Arnold, J., Srinivasan, R. and Williams, J., 2000. SURFACE WATERIM (Soil and Water Integrated Model). User Manual. PIK Report 69., Potsdam Institute for Climate Impact Research, Potsdam, Germany.
- McMahon, P.B., Tindall, J.A., Collins, J.A., Lull, K.J. and Nuttle, J.R., 1995. Hydrologic And Geochemical Effects On Oxygen-Uptake In Bottom Sediments Of An Effluent-Dominated River. *Water Resources Research*, **31**(10): 2561-2569.
- Parkin, G., et al., in preparation. River-aquifer interaction modelling for environmental management: a review.
- Prommer H, Barry, D.A., Zheng, C. (2003). MODFLOW/MT3DMS based reactive multi-component transport modeling. *Ground Water*, **41**(2).
- Quinn, P.F., Hewett, C.J.M. and Dayawansa, N.D.K., 2008. TOPCAT-NP: a minimum information requirement model for simulation of flow and nutrient transport from agricultural systems. *Hydrological Processes*, **22**(14): 2565-2580.
- Ray, C., Soong, T.W., Lian, Y.Q. and Roadcap, G.S., 2002. Effect of flood-induced chemical load on filtrate quality at bank filtration sites. *Journal Of Hydrology*, **266**(3-4): 235-258.
- Runkel, R.L., 1998, One dimensional transport with inflow and storage (OTIS): A solute transport model for streams and rivers: U.S. Geological Survey Water-Resources Investigation Report 98-4018.
- Stevens, AP, 1999. Impacts of groundwater abstraction on the trout fishery of the River Piddle, Dorset; and an approach to their alleviation. *Hydrological Processes* **13**, 487-496.
- Therrien, R., McLaren, R.G., Sudicky, E.A., Panday, S.M., 2004. HydroGeoSphere; A three-dimensional numerical model describing fully-integrated subsurface and surface flow and solute transport: user manual, 275 pp.
<http://www.science.uwaterloo.ca/~mclaren/public/hydrosphere.pdf>, accessed 10 June 2009.
- Wade, A.J., Whitehead, P.G. and Butterfield, D., 2002. The Integrated Catchments model of Phosphorus dynamics (INCA-P), a new approach for multiple source assessment in heterogeneous river systems: model structure and equations. *Hydrology and Earth System Sciences*, **6**(3): 583-606.
- Whitehead, P.G., Wilson, E.J. and Butterfield, D., 1998. A semi-distributed Integrated Nitrogen model for multiple source assessment in Catchments (INCA): Part I - model structure and process equations. *Science of the Total Environment*, **210**(1-6): 547-558.

Chapter 10

- Bednarek AT. 2001. Undamming rivers: A review of the ecological impacts of dam removal. *Environmental Management*. **27**(6): 803-814
- Boulton AJ. 2000. River ecosystem health down under: assessing ecological condition in riverine groundwater zones in Australia. *Ecosystem Health* **6**: 108–118.
- Boulton AJ. 2007. Hyporheic rehabilitation in rivers: restoring vertical connectivity. *Freshwater Biology* **52**: 632–650
- Brooks, A.P. 2006. Design guidelines for the introduction of wood in Australian streams. Land and Water, Canberra, Australia
- Calder IR. 2007. Forests and water—Ensuring forest benefits outweigh water costs. *Forest ecology and management*. **251**: 110-120
- Cobby D, Morris S, Parkes A, and Robinson V. 2009. Groundwater flood risk management: advances towards meeting the requirements of the EU flood directive. *Journal of Flood Risk Management*. **2**(2): 111-119
- Council of the European Community (CEC), 2006. Directive 2006/118/EC of the European Parliament and of the Council of 12 December 2006 on the protection of groundwater against pollution and deterioration. *Official Journal of the European Communities*, **L372/19, 27.12.2006**.
- Davy-Bowker J, Sweeting W, Wright N, Clarke RT, Arnott S. 2006. The distribution of benthic and hyporheic macroinvertebrates from the heads and tails of riffles. *Hydrobiologia* **563**: 109–123.
- Defra. 2004. Making space for water: developing a new government strategy for flood and coastal erosion risk management in England and Wales Consultation exercise Department for Food and Rural Affairs, London
- Edwards RT. 1998. The hyporheic zone. In: *River ecology and management: lessons from the Pacific coastal ecoregion*. Naiman, Robert J., and Robert E. Bilby, (editors). Springer-Verlag, New York. xxiv 705 p.
- England, J, Skinner, K.S, and Carter, M.G. 2008. Monitoring river restoration and the water framework directive. *Journal of the chartered institution of water and environmental management* **22**: 227-234
- Gillian S, Boyd K, Hoitsma T, Kauffman M. 2005. Challenges in developing and implementing ecological standards for geomorphic river restoration projects: a practitioner's response to Palmer et al. (2005). *Journal of Applied Ecology* **42**: 223-227.
- Hanna DM, Sadler JP and Wood PJ. 2007. Hydroecology and Ecohydrology: Challenges and Future Prospects. In: *Hydrology and Ecohydrology. Past, Present, and Future*. Wiley Inc. Pp: 421-429
- Harrison SSC, Pretty JL, Shepherd D, Hildrew AG, Smith C, Hey RD. 2004. The effect of instream rehabilitation structures on macroinvertebrates in lowland rivers. *Journal of Applied Ecology* **41**: 1140-1154.

- Hester ET, Doyle MW, Poole GC. 2009. The influence of in-stream structures on summer water temperatures via induced hyporheic exchange. *Limnology and Oceanography*. 54(1): 355-367
- Hicks BJ, Hall JD, Bisson PA, and Sedal JR. 1991. Responses of salmonids to habitat changes. In WR Meehand (editor) *Influences of forest and rangeland management on salmonid fishes and their habitats*. American Fisheries Society. Special Publication 19. Bethesda, Maryland. pp. 438-518
- Horn R, and Richards K. 2007. Flow-vegetation interactions in restored floodplain environments. In: *Hydroecology and Ecohydrology*. Wood PJ, Hanna DM, and Sadler JP (editors) John Wiley & Sons Ltd. Sussex, England. Pages: 269-294
- Jansson R, Nilsson C, Malmqvist B. 2007. Restoring freshwater ecosystems in riverine landscapes the roles of connectivity and recovery processes. *Freshwater Biology* **52**: 589-596.
- Kasahara T, Hill AR. 2007. Lateral hyporheic zone chemistry in an artificially constructed gravel bar and a re-meandered stream channel, southern Ontario, Canada. *Journal of the American Water Resources Association*. **43**(5): 1257-1269
- Kasahara T, Hill AR. 2006. Hyporheic exchange flows induced by constructed riffles and steps in lowland streams in southern Ontario, Canada. *Hydrological Processes* **20**: 4287–4305.
- Lautz LK and Fanelli RM. 2008. Seasonal biogeochemical hotspots in the streambed around restoration structures. *Biogeochemistry*. **91**: 85-104
- Mant, J.M and Janes, M.D. (2006) River and floodplains. In: Van Andel, J. and Harris, J. (eds) *Restoration Ecology* SER.
- Malcolm IA, Soulsby C, Youngson AF and Tetzlaff D. 2008. Fine scale variability of hyporheic hydrochemistry in salmon spawning gravels with contrasting groundwater-surface water interactions. *Hydrogeology Journal*. **17**(1): 1431-2174
- Meyer EI, Niepagenkemper O, Molls F, Spänhoff. 2008. An experimental assessment of the effectiveness of gravel cleaning operations in improving hyporheic water quality in potential salmonids spawning areas. *River Research and Applications*. **24**: 119-131
- Newson, M. D. and A. R. G. Large. 2006. 'Natural' rivers, 'hydromorphological quality' and river restoration: a challenging new agenda for applied fluvial geomorphology. *Earth Surf Process Landforms* **31**:1606–1624.
- Palmer MA, Bernhardt ES, Allan JD, Lake PS, Alexander G, Brooks S, Carr J, Clayton S, Dahm CN, Follstad Shah J, Galat DL, Loss SG, Goodwin P, Hart DD, Hassett B, Jenkins R, Kondolf GM, Lave R, Meyer JL, O'Donnell, TK, Pagano L, Sudduth E. 2005. Standards for ecologically successful river restoration. *Journal of Applied Ecology* **42**: 208-217.
- Pepin DM, and Hauer FR. 2002. Benthic Responses to Groundwater-Surface Water Exchange in 2 Alluvial Rivers in Northwestern Montana. *Journal of the North American Benthological Society*. **21**(3): 370-383

- Pess GR, Morley SA, Hall JL, and Timm RK. 2005. Monitoring floodplain restoration. In: Monitoring streams and Watershed Restoration. Roni P (editor). American Fisheries Society. Bethesda, MD. USA
- Postel, Sandra and Brian Richter. 2003. Rivers for Life: Managing Water for People and Nature (Washington, D.C.: Island Press).
- Reichert P, Borsuk M, Hostmann M, Schweizer S, Spörri C, Tockner K, and Truffer B. 2007. Concepts of decision support for river rehabilitation. Environmental Modelling and Software. **22**(2): 188-201
- Riley AL. 1998. Restoring streams in cities: a guide for planners, policy makers, and citizens. Island Press, 1998
- Roni P (editor). 2005. Monitoring stream and watershed restoration. American Fisheries Society, Bethesda, MD. USA.
- Roni, P., M. Liermann, and A. Steel. 2003. Monitoring and evaluating responses of salmonids and other fishes to in-stream restoration. In D.R. Montgomery, S. Bolton, and D.B. Booth, (editors), Restoration of Puget Sound Rivers, University of Washington Press. pp. 318-339
- RRC. 2002. Manual of River Restoration Techniques. River Restoration Centre– Web Edition 2002. http://www.therrc.co.uk/rrc_manual_pdf.php
- Smith JWN, Bonell M, Gibert J, McDowell WH, Sudicky EA, Turner JV, Harris RC. 2008. Groundwater-surface water interactions, nutrient fluxes and ecological response in river corridors: Translating science into effective environmental management. Hydrological Processes. **22**: 151-1
- Underwood AJ. 1994. On Beyond BACI: Sampling Designs that Might Reliably Detect Environmental Disturbances. Ecological Applications. **4**(1): 4-15
- Vis M, Klijn F, De Bruijn KM, and Van Buuren M. 2003. Resilience strategies for flood risk management in the Netherlands. International Journal of River Basin Management. **1**(1): 33-40
- Wohl E, Angermeier PL, Bledsoe B, Kondolf GM, MacDonnel L, Merritt DM, Palmer MA, Pof NL, Tarboton D. 2005. River Restoration. Water Resources Research. **41**: W10301, doi:10.1029/2005WR003985

Chapter 11

- Environment Agency, 2006. Hydrogeological risk assessment for land contamination: Remedial Targets Methodology. Environment Agency R&D Publication 20. EA, Bristol.
- Environment Agency, 2000. Guidance on the assessment and monitoring of natural attenuation of contaminants in groundwater. Environment Agency R&D Publication 95. EA, Bristol.

**Would you like to find out more about us,
or about your environment?**

Then call us on

08708 506 506* (Mon-Fri 8-6)

email

enquiries@environment-agency.gov.uk

or visit our website

www.environment-agency.gov.uk

incident hotline 0800 80 70 60 (24hrs)

floodline 0845 988 1188

* Approximate call costs: 8p plus 6p per minute (standard landline).
Please note charges will vary across telephone providers



Environment first: This publication is printed on recycled paper.